

# Foreword

This manual was prepared to help you understand the operation and maintenance of your vehicle so that you may enjoy many kilometers (miles) of driving pleasure. Please read through this manual before operating your vehicle.

A separate Warranty Information & Maintenance Booklet explains details about the warranties covering your vehicle.

Your NISSAN dealer knows your vehicle best. When you require any service or have any questions, we will be glad to assist you with the extensive resources available for you.

## IMPORTANT SAFETY INFORMATION

### Reminders for safety!

Follow these important driving rules to help ensure a safe and complete trip for you and your passengers!

- **NEVER drive under the influence of alcohol or drugs.**
- **ALWAYS observe posted speed limits and never drive too fast for conditions.**
- **ALWAYS use your seat belts and appropriate child restraint systems. Preteen children should be seated in the rear seat.**
- **ALWAYS provide information about the proper use of vehicle safety features to all occupants of the vehicle.**
- **ALWAYS review this Owner's Manual for important safety information.**

### When reading the manual

This manual includes information for all options available on this model. Therefore, you may find some information that does not apply to your vehicle.

Throughout this manual, some illustrations may only show the layout for Right-Hand Drive (RHD) models. For Left-Hand Drive (LHD) models, the illustrated shape and location of some components may differ.

All information, specifications and illustrations in this manual are those in effect at the time of printing. NISSAN reserves the right to change specifications or designs without notice and without obligation.

### MODIFICATION OF YOUR VEHICLE

This vehicle should not be modified. Modification could affect its performance, safety or durability, and may even violate governmental regulations. In addition, damage or performance problems resulting from modifications may not be covered under NISSAN warranties.

### Read first - then drive safely

Before driving your vehicle, read this Owner's Manual carefully. This will ensure familiarity with controls and maintenance requirements, assisting you in the safe operation of your vehicle.

Throughout this manual we have used the symbol  followed by the word **WARNING**. This is used to indicate the presence of a hazard that could cause death or serious personal injury. To avoid or reduce the risk, the procedures must be followed precisely.

The symbol  followed by the word **CAUTION** is also used throughout this manual to indicate the presence of a hazard that could

cause minor or moderate personal injury or damages to your vehicle. To avoid or reduce the risk, the procedures must be followed carefully.

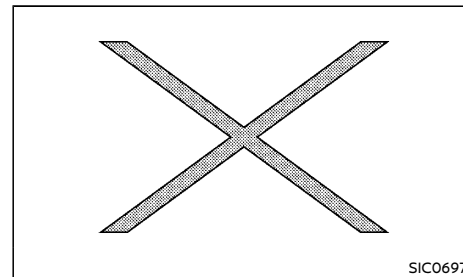

If you see this symbol, it means **"Do not do this"** or **"Do not let this happen"**.

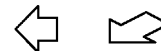

If you see a symbol similar to these in an illustration, it means the arrow points to the front of the vehicle.



Arrows in an illustration that are similar to these indicate movement or action.



Arrows in an illustration that are similar to these call attention to an item in the illustration.



Bluetooth® is a trademark owned by Bluetooth SIG, Inc. and licensed to Shenzhen Hangsheng Electronics Co., Ltd.

**Air bag warning labels:**



"NEVER use a rearward facing child restraint on a seat protected by an ACTIVE AIRBAG in front of it, DEATH or SERIOUS INJURY to the CHILD can occur."

Be sure to read "Air bag warning labels" (P.1-22).

© 2021 NISSAN MOTOR CO., LTD.

# Table of Contents

<b>Illustrated table of contents</b>	<b>0</b>
<b>Safety – seats, seat belts and supplemental restraint system</b>	<b>1</b>
<b>Instruments and controls</b>	<b>2</b>
<b>Pre-driving checks and adjustments</b>	<b>3</b>
<b>Monitor, heater and air conditioner, and audio system</b>	<b>4</b>
<b>Starting and driving</b>	<b>5</b>
<b>In case of emergency</b>	<b>6</b>
<b>Appearance and care</b>	<b>7</b>
<b>Maintenance and do-it-yourself</b>	<b>8</b>
<b>Technical information</b>	<b>9</b>
<b>Index</b>	<b>10</b>



# 0 Illustrated table of contents

Seats, seat belts and Supplemental Restraint System (SRS) .....	0-2	Instrument panel .....	0-8
Exterior front .....	0-3	Left-Hand Drive (LHD) model .....	0-8
Exterior rear .....	0-4	Right-Hand Drive (RHD) model .....	0-9
Passenger compartment .....	0-5	Meters and gauges .....	0-10
Cockpit .....	0-6	Engine compartment .....	0-12
Left-Hand Drive (LHD) model .....	0-6	HRAODET engine model .....	0-12
Right-Hand Drive (RHD) model .....	0-7		

## SEATS, SEAT BELTS AND SUPPLEMENTAL RESTRAINT SYSTEM (SRS)

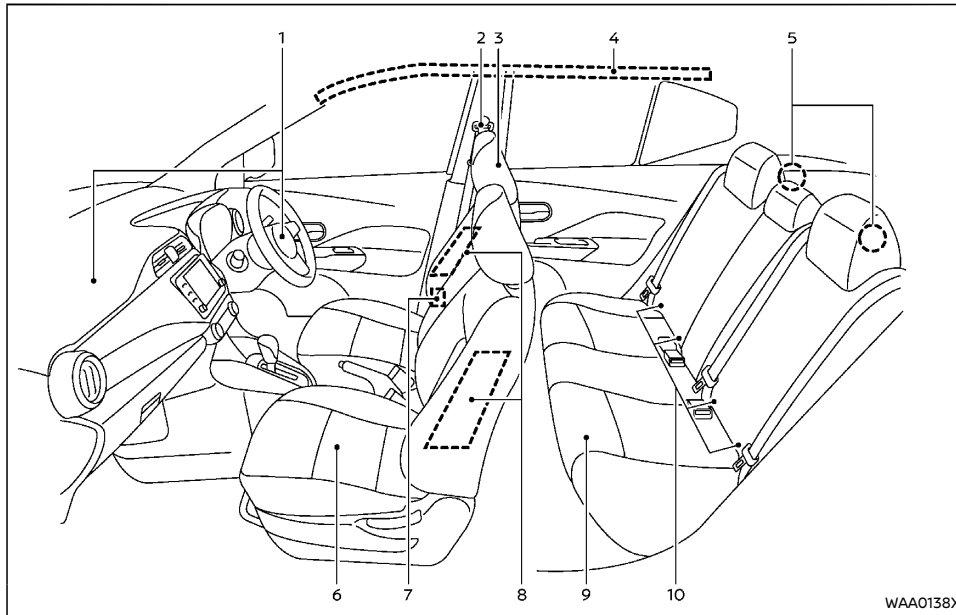

- |  |  |
|--|--|
| 1. Supplemental front-impact air bags (P.1-19)                                   | 8. Supplemental side-impact air bags* (P.1-19) |
| 2. Seat belts (P.1-6)  | 9. Rear seats (P.1-3)                          |
| 3. Head restraints (P.1-4)   | — Child restraints (P. 1-10)                   |
| 4. Supplemental curtain side-impact air bags* (P.1-19)                           | 10. ISOFIX child restraint system (P.1-13)     |
| 5. Child restraint anchor points (for top tether strap child restraint) (P.1-14) | *: if equipped                                 |
| 6. Front seats (P.1-2)   |  |
| 7. Pre-tensioner seat belt system* (P.1-27)                                      |  |

## EXTERIOR FRONT

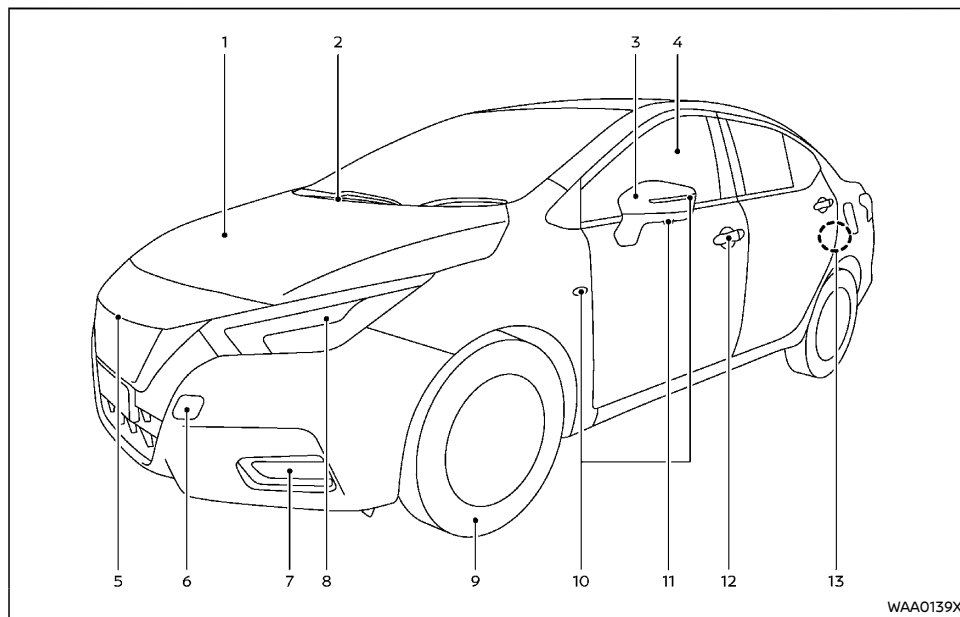

- |   |   |
|---|---|
| 1. Hood (P.3-16)  | 8. Headlights and turn signal lights (P.2-30)   |
| 2. Windshield wiper and washer <ul style="list-style-type: none"><li>– Wiper and washer switch (P.2-33)</li><li>– Washer fluid (P.8-13)</li></ul> | 9. Tires <ul style="list-style-type: none"><li>– Tires and wheels (P.8-23, P.9-5)</li><li>– Flat tire (P.6-2)</li></ul> |
| 3. Outside rearview mirrors (P.3-20)  | 10. Side turn signal lights (on the front fender or the outside rearview mirror) (P.2-32)                               |
| 4. Windows (P.2-35)   | 11. Side view camera* (P.4-3)   |
| 5. Front view camera* (P.4-3)   | 12. Doors <ul style="list-style-type: none"><li>– Keys (P.3-2)</li><li>– Door locks (P.3-3)</li></ul>                   |
| 6. Recovery hook (P.6-14)   |   |
| 7. Fog lights* (P.2-33)   |   |

- Remote keyless entry system\* (P.3-5)
  - Intelligent Key system\* (P.3-6)
13. Child safety rear door locks (P.3-4)  
\*: if equipped

## EXTERIOR REAR

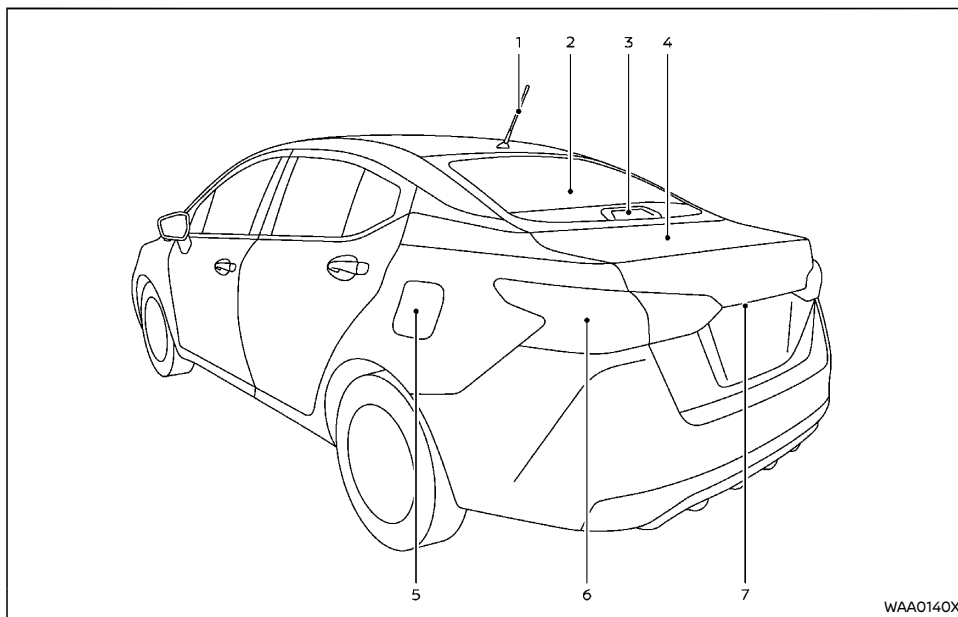

- |  |                                     |
|--|-------------------------------------|
| 1. Antenna* (P.4-32)                   | 6. Rear combination lights (P.8-19) |
| 2. Rear window                         | 7. Rear view camera* (P.4-3)        |
| — Rear window defogger (P.2-34)        | *: if equipped                      |
| — Antenna* (P.4-32)                    |                                     |
| 3. High-mounted stop light (P.8-19)    |                                     |
| 4. Trunk (P.3-17)                      |                                     |
| — Remote keyless entry system* (P.3-5) |                                     |
| — Intelligent Key system* (P.3-6)      |                                     |
| 5. Fuel-filler lid (P.3-18)            |                                     |



## PASSENGER COMPARTMENT

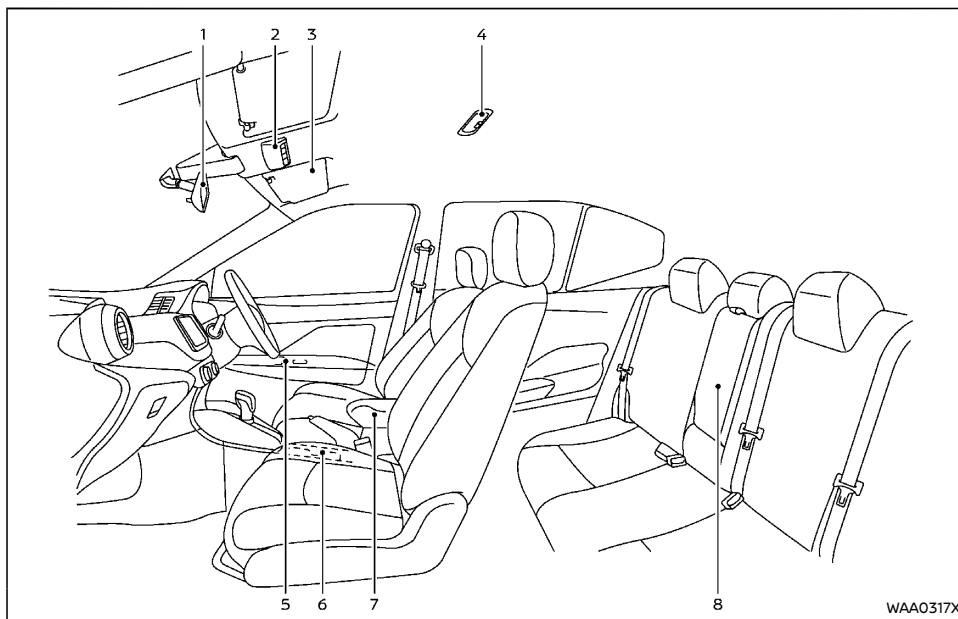

- |   |  |
|---|--|
| 1. Inside rearview mirror (P.3-19)  | 6. Cup holders (P.2-39)                                    |
| 2. Map lights (P.2-41)  | 7. Console box*  |
| 3. Sun visor (P.2-40)   | – Power outlet* (P.2-37)                                   |
| 4. Room light (P.2-41)  | – USB (Universal Serial Bus) charging connectors* (P.2-37) |
| 5. Door armrest   | 8. Rear armrest* (P.1-4)                                   |
| – Power window switch (P.2-35)  | – Rear cup holders (P.2-39)                                |
| – Power door lock switch (driver's side) (P.3-4)                          |  |
| – Outside rearview mirror remote control switch (driver's side)* (P.3-20) | *: if equipped   |

## COCKPIT

### LEFT-HAND DRIVE (LHD) MODEL

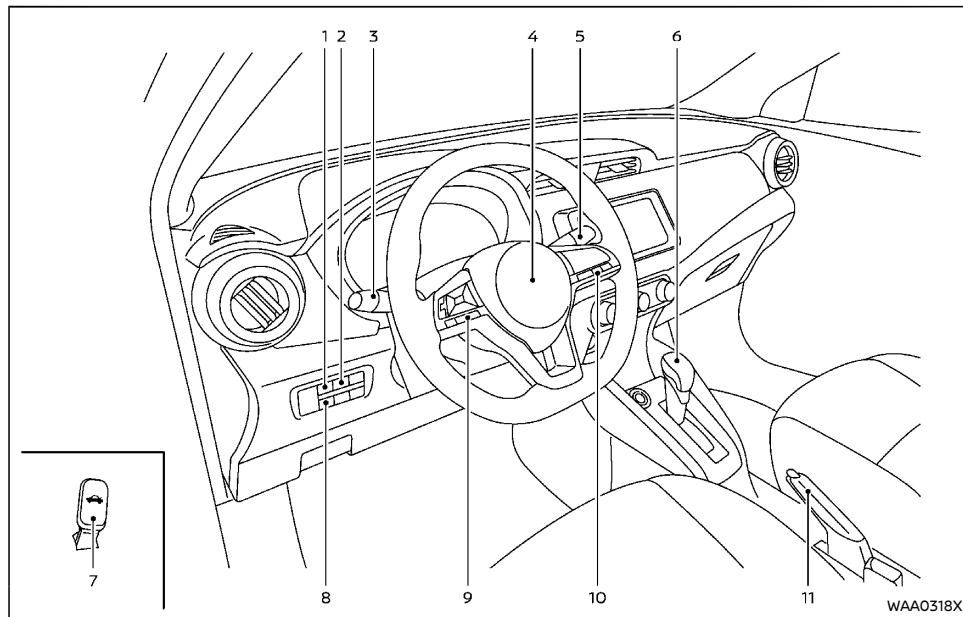

1. Trip computer mode switch\* (P.2-18)
2. Vehicle Dynamic Control (VDC) OFF switch\* (P.5-18)
3. Headlight, fog light\* and turn signal switch
  - Headlight and turn signal switch (P.2-30)
  - Fog light switch\* (P.2-33)
4. Steering wheel
  - Electric power steering (P.5-39)
  - Horn (P.2-35)
5. Wiper and washer switch (P.2-33)
6. Shift lever
  - Continuously Variable Transmission (CVT) (P.5-11)
  - Manual Transmission (MT) (P.5-14)

7. Trunk lid release lever (on the driver's side floor) (P.3-17)
  8. Idling Stop OFF switch\* (P.5-15)
  9. Steering-wheel-mounted controls (left side)\*
    - Vehicle information display control\* (P.2-19)
    - Audio control (P.4-30 or \*\*)
  10. Steering-wheel-mounted controls (right side)\*\*
    - Bluetooth® Hands-Free Phone System control
    - Smartphone voice control
  11. Parking brake (P.3-21)
- \*: if equipped  
\*\*: See the separate NissanConnect Owner's Manual (if equipped).

## RIGHT-HAND DRIVE (RHD) MODEL

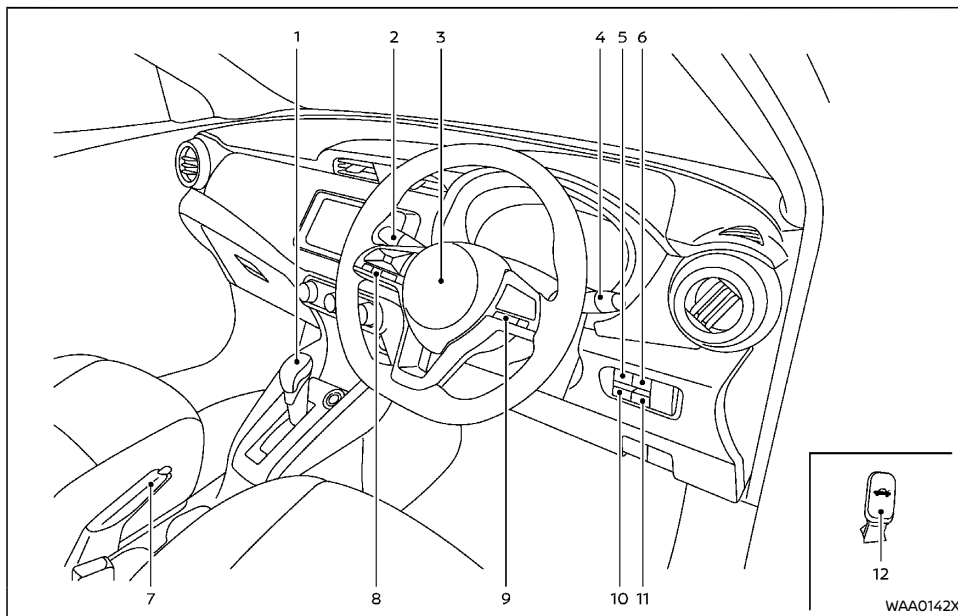

- |  |   |
|--|---|
| 1. Shift lever<br>– Continuously Variable Transmission (CVT) (P.5-11)      | – Headlight and turn signal switch (P.2-30)           |
| 2. Wiper and washer switch (P.2-33)  | – Fog light switch* (P.2-33)                          |
| 3. Steering wheel<br>– Electric power steering (P.5-39)<br>– Horn (P.2-35) | 5. Vehicle Dynamic Control (VDC) OFF switch* (P.5-18) |
| 4. Headlight, fog light* and turn signal switch                            | 6. Trip computer mode switch* (P.2-18)                |
|  | 7. Parking brake (P.3-21)                             |
|  | 8. Steering-wheel-mounted controls (left side)*       |

- Vehicle information display control\* (P.2-19)
  - Audio control (P.4-30 or \*\*)
  - Bluetooth® Hands-Free Phone System control\* (P.4-33)
9. Steering-wheel-mounted controls (right side)\*\*
    - Bluetooth® Hands-Free Phone System control
    - Smartphone voice control
  10. Intelligent Emergency Braking system OFF switch\* (P.5-30)
  11. Idling Stop OFF switch (P.5-15)
  12. Trunk lid release lever (on the driver's side floor) (P.3-17)
- \*: if equipped  
 \*\*: See the separate NissanConnect Owner's Manual (if equipped).

## INSTRUMENT PANEL

### LEFT-HAND DRIVE (LHD) MODEL

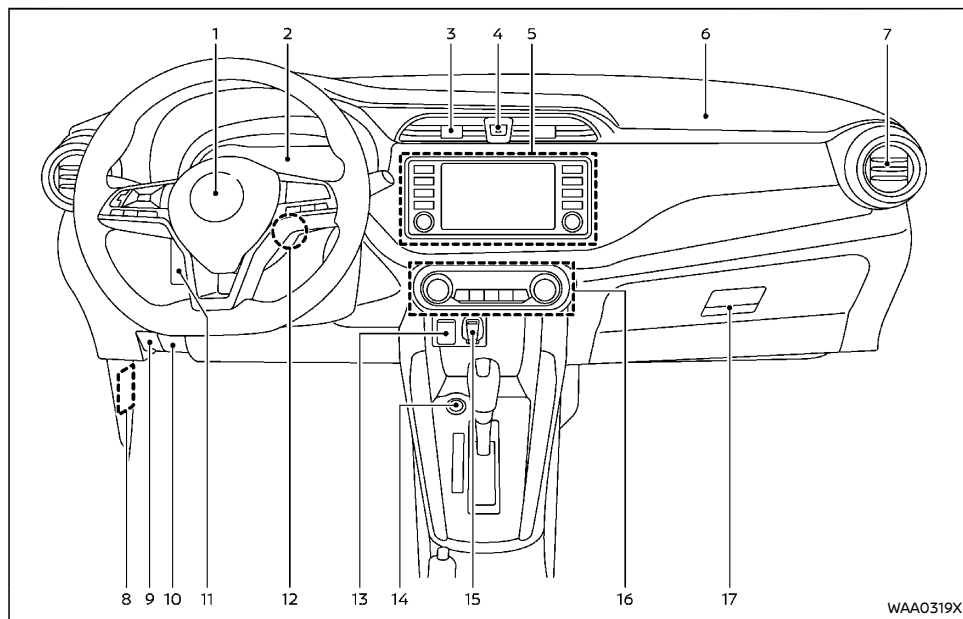

- |   |   |
|---|---|
| 1. Steering wheel<br>— Driver's front-impact air bag (P.1-19) | 7. Side ventilator (P.4-13)   |
| 2. Meters and gauges (P.2-6)                                  | 8. Fuse box cover (P.8-17)  |
| 3. Center ventilator (P.4-13)                                 | 9. Fuel-filler lid release handle (P.3-18)  |
| 4. Hazard indicator flasher switch (P.6-2)                    | 10. Hood release handle (P.3-16)  |
| 5. Audio system (P.4-20 or **)                                | 11. Steering wheel lock lever (P.3-19)  |
| 6. Passenger's front-impact air bag (P.1-19)                  | 12. Ignition switch (models without Intelligent Key system) (P.5-6)                 |
|   | 13. USB (Universal Serial Bus) connection port/Auxiliary input jack* (P.4-31 or **) |

14. Push-button ignition switch (models with Intelligent Key system) (P.5-7)
15. Power outlet (P.2-37)
16. Heater\* and air conditioner (P.4-14)  
— Defogger switch (P.2-34)
17. Glove box (P.2-38)
- \*: if equipped
- \*\*: See the separate NissanConnect Owner's Manual (if equipped).

## RIGHT-HAND DRIVE (RHD) MODEL

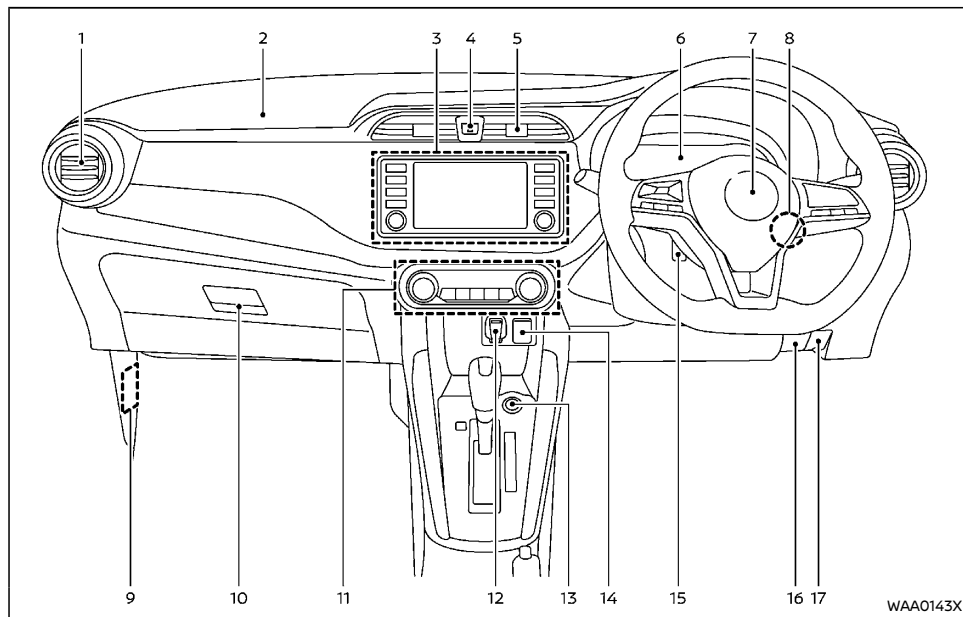

- |   |  |
|---|--|
| 1. Side ventilator (P.4-13)                                   | 8. Ignition switch (models without Intelligent Key system) (P.5-6)           |
| 2. Passenger's front-impact air bag (P.1-19)                  | 9. Fuse box cover (P.8-17)   |
| 3. Audio system (P.4-20 or **)                                | 10. Glove box (P.2-38)   |
| 4. Hazard indicator flasher switch (P.6-2)                    | 11. Heater* and air conditioner (P.4-14)<br>— Defogger switch (P.2-34)       |
| 5. Center ventilator (P.4-13)                                 | 12. Power outlet (P.2-37)  |
| 6. Meters and gauges (P.2-6)                                  | 13. Push-button ignition switch (models with Intelligent Key system) (P.5-7) |
| 7. Steering wheel<br>— Driver's front-impact air bag (P.1-19) |  |

14. USB (Universal Serial Bus) connection port/Auxiliary input jack\* (P.4-31 or \*\*)
15. Steering wheel lock lever (P.3-19)
16. Hood release handle (P.3-16)
17. Fuel-filler lid release handle (P.3-18)
- \*: if equipped
- \*\* : See the separate NissanConnect Owner's Manual (if equipped).

## METERS AND GAUGES

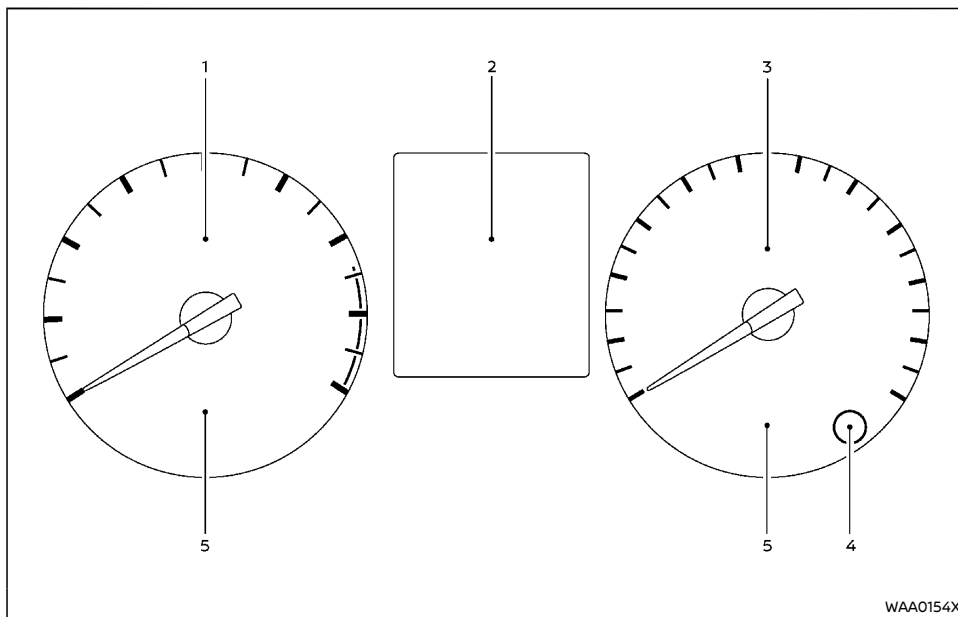

WAA0154X

### Type A

1. Tachometer (P.2-8)
2. Vehicle information display (P.2-18)
  - Trip computer (P.2-18)
  - Continuously Variable Transmission (CVT) position indicator\* (P.2-11, P.5-11)
  - Odometer/twin trip odometer (P.2-8)
  - Fuel gauge (P.2-9)
3. Speedometer (P.2-8)
4. Trip reset switch (P.2-8)/Instrument brightness control knob (P.2-10)
5. Warning and indicator lights (P.2-12)
  - \*: if equipped

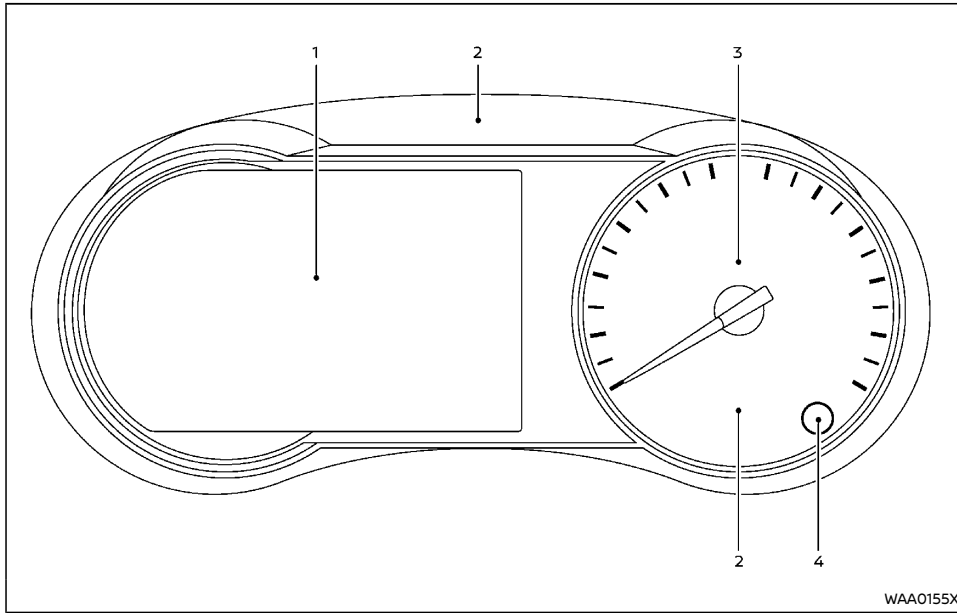

WAA0155X

**Type B**

- |   |  |
|---|--|
| <ol style="list-style-type: none"> <li>1. Vehicle information display (P.2-19)           <ul style="list-style-type: none"> <li>– Tachometer (P.2-8)</li> <li>– Odometer/twin trip odometer (P.2-8)</li> <li>– Fuel gauge (P.2-9)</li> <li>– Trip computer (P.2-28)</li> <li>– Continuously Variable Transmission (CVT) position indicator* (P.2-11, P.5-11)</li> </ul> </li> <li>2. Warning and indicator lights (P.2-12)</li> <li>3. Speedometer (P.2-8)</li> </ol> | <ol style="list-style-type: none"> <li>4. Trip reset switch (P.2-8)/Instrument brightness control knob (P.2-10)</li> </ol> <p>*: if equipped</p> |
|---|--|

# ENGINE COMPARTMENT

## HRAODET ENGINE MODEL

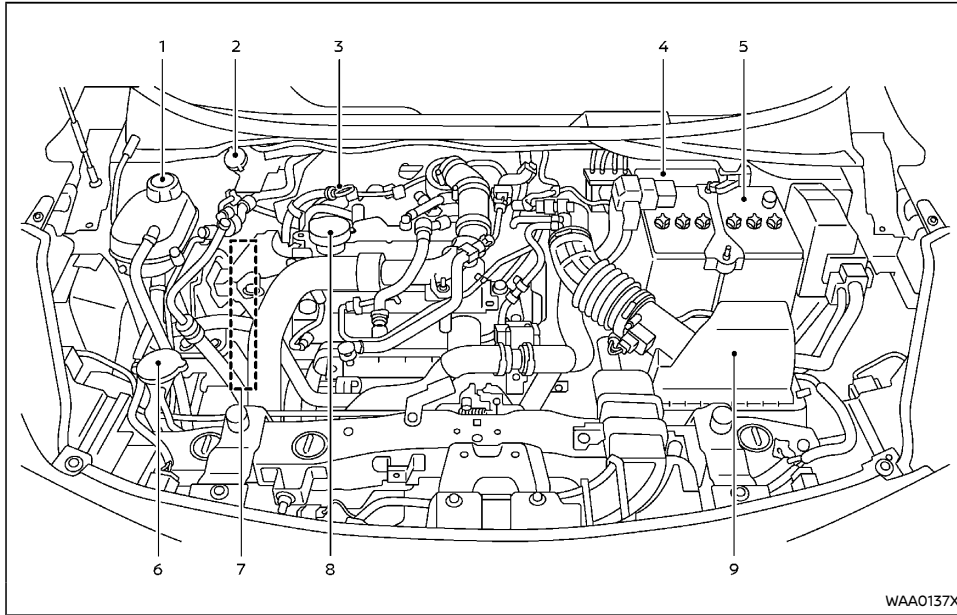

- |  |   |
|--|---|
| 1. Engine coolant reservoir (P.8-6)                      | 8. Engine oil filler cap (P.8-7)  |
| 2. Brake and clutch*1 fluid reservoir*2 (P.8-10, P.8-11) | 9. Air cleaner (P.8-12)   |
| 3. Engine oil dipstick (P.8-7)                           | *1: For Manual Transmission (MT) model  |
| 4. Fuse/fusible link box (P.8-17)                        | *2: The layout illustrated is for the Right-Hand Drive (RHD) model. On the Left-Hand Drive (LHD) model, brake (and clutch) fluid reservoir is located on the opposite side. |
| 5. Battery (P.8-14)                                      |   |
| 6. Window washer fluid reservoir (P.8-13)                |   |
| 7. Engine drive belt location (P.8-9)                    |   |



# 1 Safety — seats, seat belts and supplemental restraint system

Seats .....	1-2	Child restraints .....	1-10
Front seats .....	1-2	Precautions on child restraint usage .....	1-10
Rear seats .....	1-3	Universal child restraints for front seat and rear seats .....	1-11
Armrest (if equipped) .....	1-4	ISOFIX child restraint system .....	1-13
Head restraints .....	1-4	Child restraint anchorage .....	1-14
Adjustable head restraint .....	1-4	Child restraint installation using ISOFIX .....	1-14
Non-adjustable head restraint .....	1-4	Child restraint installation using three-point type seat belt .....	1-16
Remove .....	1-5	Supplemental Restraint System (SRS) .....	1-19
Install .....	1-5	Precautions on Supplemental Restraint System (SRS) .....	1-19
Adjust .....	1-5	Supplemental air bag systems .....	1-23
Seat belts .....	1-6	SRS air bag deployment conditions .....	1-25
Precautions on seat belt usage .....	1-6	Pre-tensioner seat belt system (if equipped) .....	1-27
Child safety .....	1-8	Repair and replacement procedure .....	1-27
Pregnant women .....	1-8		
Injured persons .....	1-9		
Three-point type seat belts .....	1-9		
Seat belt maintenance .....	1-9		

## SEATS

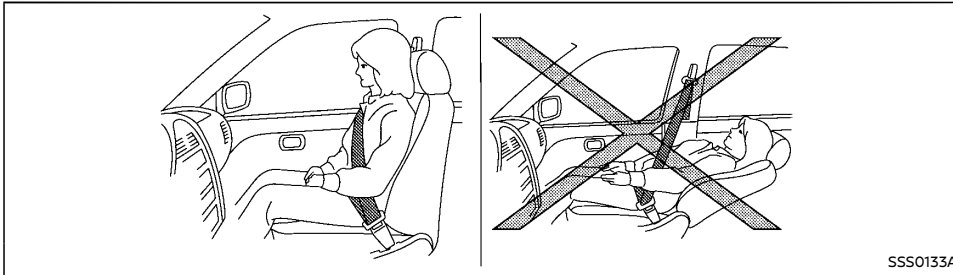

### **WARNING:**

- Do not drive and/or ride in the vehicle with the seatback reclined. This can be dangerous. The shoulder belt will not be properly against the body. In an accident, you and your passengers could be thrown into the shoulder belt and receive neck or other serious injuries. You and your passengers could also slide under the lap belt and receive serious injuries.
- For the most effective protection while the vehicle is in motion, the seatback should be upright. Always sit well back and upright in the seat and adjust the seat belt properly. (See "Seat belts" (P.1-6).)
- Do not leave children unattended inside the vehicle. They could unknowingly activate switches or controls. Unattended children could become involved in serious accidents.
- To help avoid risk of injury or death through unintended operation of the vehicle and/or its systems, do not leave children, people who require the assis-

tance of others or pets unattended in your vehicle. Additionally, the temperature inside a closed vehicle on a warm day can quickly become high enough to cause a significant risk of injury or death to people and pets.

### **CAUTION:**

When adjusting the seat positions, be sure not to contact any moving parts to avoid possible injuries and/or damages.

## FRONT SEATS

### **WARNING:**

Do not adjust the driver's seat while driving so that full attention may be given to vehicle operation.

## Adjustment

### **WARNING:**

After adjusting a seat, gently shake the seat to confirm that the seat is locked securely. If the seat is not locked securely, it may move suddenly and could cause the loss of control of the vehicle.

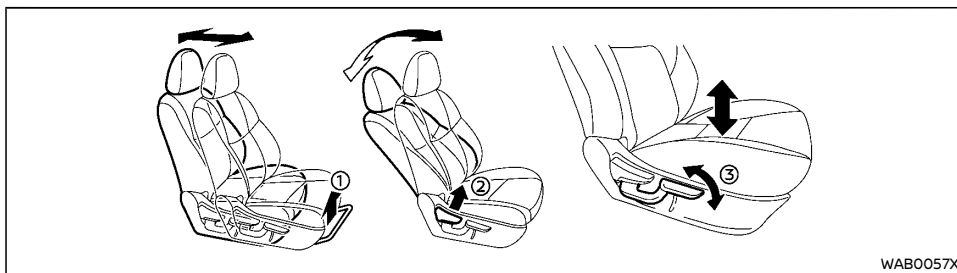

#### Forward and backward:

1. Pull up the adjusting lever ①.
2. Slide the seat to the desired position.
3. Release the adjusting lever to lock the seat in position.

#### Reclining:

1. Pull up the adjusting lever ②.
2. Tilt the seatback to the desired position.
3. Release the adjusting lever to lock the seatback in position.

The reclining feature allows the adjustment of the seatback for occupants of different sizes to help obtain the proper seat belt fit. (See "Seat belts" (P.1-6).)

The seatback may be reclined to allow occupants to rest when the vehicle is parked.

#### Seat lifter (if equipped):

Pull up or push down the adjusting lever ③ to adjust the seat height until the desired position is achieved.

#### REAR SEATS

##### Folding (if equipped)



#### WARNING:

- Never allow anyone to ride in the luggage area or on the rear seats when they are in the fold-down position. Use of these areas by passengers without proper restraints could result in serious injury in an accident or sudden stop.
- Do not fold down the rear seats when occupants are in the rear seat area or any luggage is on the rear seats.
- Properly secure all luggage to help prevent it from sliding or shifting. Do not place luggage higher than the seatbacks.
- When returning the seatbacks to the upright position, be certain they are completely secured in the latched position. If they are not completely secured, passengers may be injured in an accident or sudden stop.
- Closely supervise children when they are around cars to prevent them from playing and becoming locked in the trunk

where they could be seriously injured. Keep the car locked, with the rear seatback and trunk lid securely latched when not in use, and prevent children's access to car keys.

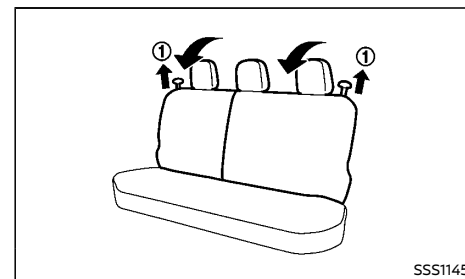

To fold the seatback, pull the knob ①.

To return the seatback to the seating position, lift up each seatback and push it to the upright position until it is latched.



#### CAUTION:

- When loading the luggage in the luggage area, be careful not to scratch or damage the seat belt.
- When operating the seatback, be careful not to scratch or damage the seat belt.

## HEAD RESTRAINTS

### ARMREST (if equipped)

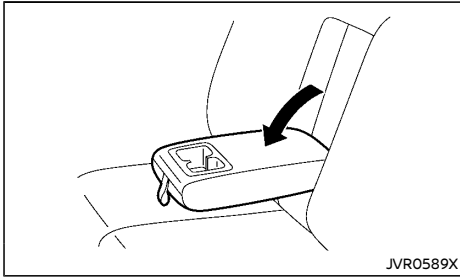

Pull the armrest forward until it is horizontal.



### WARNING:

Head restraints supplement the other vehicle safety systems. They may provide additional protection against injury in certain rear end collisions. Adjustable head restraints must be adjusted properly, as specified in this section. Check the adjustment after someone else uses the seat. Do not attach anything to the head restraint stalks or remove the head restraint. Do not use the seat if the head restraint has been removed. If the head restraint was removed, reinstall and properly adjust the head restraint before an occupant uses the seating position. Failure to follow these instructions can reduce the effectiveness of the head restraint. This may increase the risk of serious injury or death in a collision.

- Your vehicle is equipped with a head restraint that may be integrated, adjustable or non-adjustable.
- Adjustable head restraints have multiple notches along the stalk to lock them in a desired adjustment position.
- The non-adjustable head restraints have single locking notch to secure them to the seat frame.
- Proper Adjustment:
  - For the adjustable type, align the head restraint so the center of your ear is approximately level with the center of the head restraint.
  - If your ear position is still higher than the recommended alignment, place the head restraint at the highest position.
- If the head restraint has been removed, ensure that it is reinstalled and locked in place before riding in that designated

seating position.

### ADJUSTABLE HEAD RESTRAINT

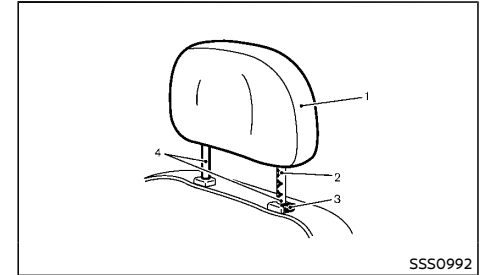

1. Removable head restraint
2. Multiple notches
3. Lock knob
4. Stalks

### NON-ADJUSTABLE HEAD RESTRAINT

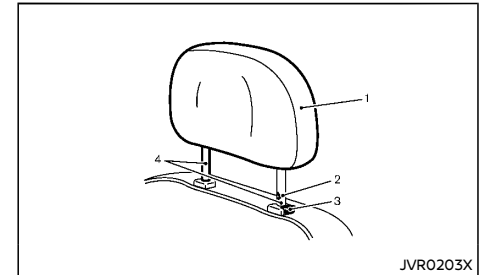

1. Removable head restraint
2. Single notch

3. Lock knob
4. Stalks

## REMOVE

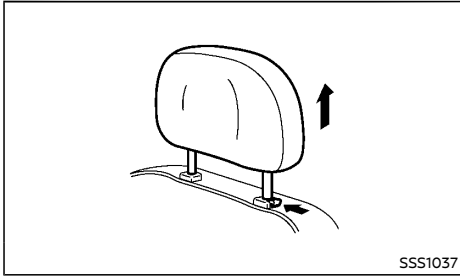

Use the following procedure to remove the head restraint.

1. Pull the head restraint up to the highest position.
2. Push and hold the lock knob.
3. Remove the head restraint from the seat.
4. Store the head restraint properly in a secure place so it is not loose in the vehicle.
5. Reinstall and properly adjust the head restraint before an occupant uses the seating position.

## INSTALL

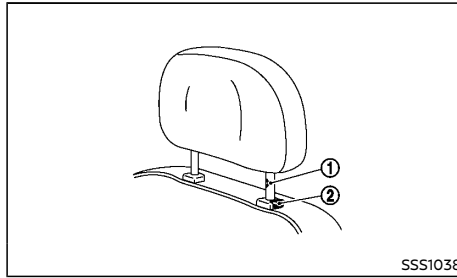

1. Align the head restraint stalks with the holes in the seat. Make sure that the head restraint is facing the correct direction. The stalk with the adjustment notch ① must be installed in the hole with the lock knob ②.
2. Push and hold the lock knob and push the head restraint down.
3. Properly adjust the head restraint before an occupant uses the seating position.

## ADJUST

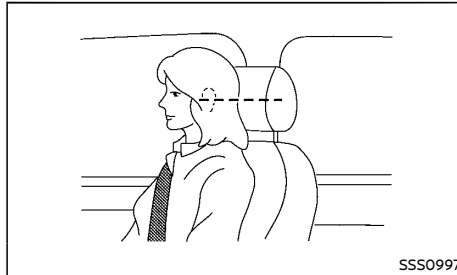

## For adjustable head restraint

Adjust the head restraint so the center is level with the center of your ears. If your ear position is still higher than the recommended alignment, place the head restraint at the highest position.

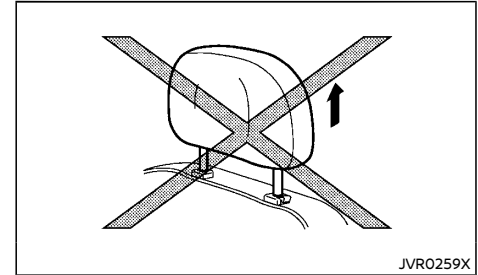

## For non-adjustable head restraint

Make sure the head restraint is positioned from the stored position or any non-latch position so the lock knob is engaged in the notch before riding in that designated seating position.

## Raise

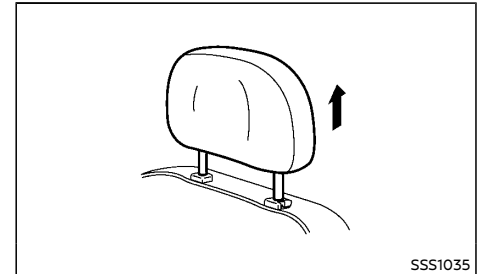

To raise the head restraint, pull it up.

## SEAT BELTS

Make sure the head restraint is positioned from the stored position or any non-latch position so the lock knob is engaged in the notch before riding in that designated seating position.

### Lower

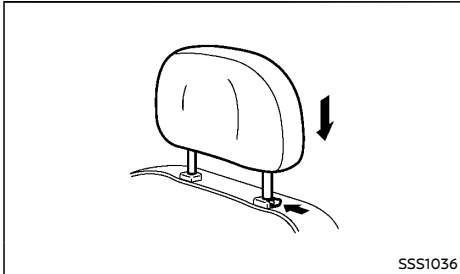

To lower, push and hold the lock knob and push the head restraint down.

Make sure the head restraint is positioned so the lock knob is engaged in the notch before riding in that designated seating position.

### PRECAUTIONS ON SEAT BELT USAGE

If you are wearing the seat belt properly adjusted and sitting upright and well back in the seat, chances of being injured or killed in an accident and/or the severity of injury may be greatly reduced. NISSAN strongly encourages you and all of your passengers to buckle up every time you drive, even if your seating position includes the supplemental air bag systems.

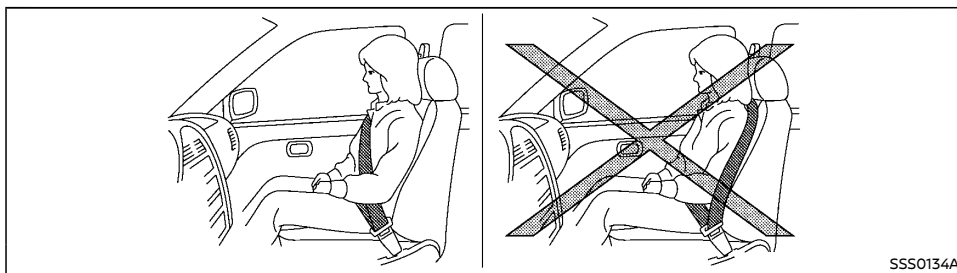

SSS0134A

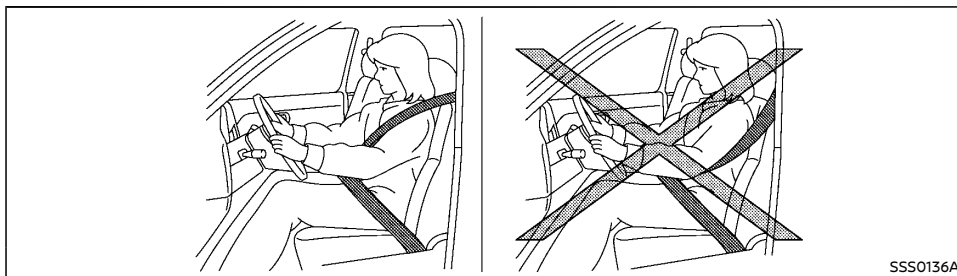

SSS0136A

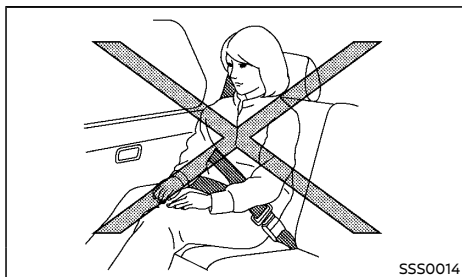

SSS0014

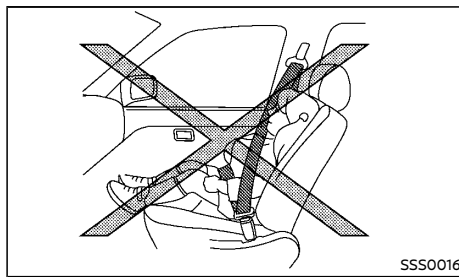

SSS0016

**⚠ WARNING:**

- Seatbelts are designed to bear upon the bony structure of the body, and should be worn low across the front of the pelvis or the pelvis, chest and shoulders, as applicable; wearing the lap section of the belt across the abdominal area must be avoided. Serious injury may occur if a seat belt is not worn properly.
- Position the lap belt as low and snug as possible around the hips, not the waist. A lap belt worn too high could increase the risk of internal injuries in an accident.
- Do not allow more than one person to use the same seat belt. Each belt assembly must only be used by one occupant; it is dangerous to put a belt around a child being carried on the occupant's lap.
- Never carry more people in the vehicle than there are seat belts.
- Never wear seat belts inside out. Belts should not be worn with straps twisted. Doing so may reduce their effectiveness.
- Seatbelts should be adjusted as firmly as possible, consistent with comfort, to provide the protection for which they have been designed. A slack belt will greatly reduce the protection afforded to the wearer.
- Every person who drives or rides in this vehicle should use a seat belt at all times. Children should be properly restrained in the rear seat and, if appropriate, in a child restraint system.
- Do not put the belt behind your back or under your arm. Always route the shoulder belt over your shoulder and across your chest. The belt should be

away from your face and neck, but not falling off your shoulder. Serious injury may occur if a seat belt is not worn properly.

- No modifications or additions should be made by the user which will either prevent the seat belt adjusting devices from operating to remove slack, or prevent the seat belt assembly from being adjusted to remove slack.
- Care should be taken to avoid contamination of the webbing with polishes, oils and chemicals, and particularly battery acid. Cleaning may safely be carried out using mild soap and water. The belt should be replaced if webbing becomes frayed, contaminated or damaged.
- All seat belt assemblies including retractors and attaching hardware should be inspected after any collision by a NISSAN dealer. NISSAN recommends that all seat belt assemblies in use during a collision be replaced unless the collision was minor and the belts show no damage and continue to operate properly. Seat belt assemblies not in use during a collision should also be inspected and, when necessary, replaced if either damage or improper operation is noted.
- It is essential to replace the entire assembly after it has been worn in a severe impact even if damage to the assembly is not obvious.
- Once the pre-tensioner seat belt has activated, it cannot be reused. It must be replaced together with the retractor. Contact a NISSAN dealer.
- Removal and installation of the pre-tensioner seat belt system components

should be done by a NISSAN dealer.

## CHILD SAFETY



### WARNING:

- Infants and children need special protection. The vehicle's seat belts may not fit them properly. The shoulder belt may come too close to the face or neck. The lap belt may not fit over their small hipbones. In an accident, an improperly fitted seat belt could cause serious or fatal injury.
- Always use an appropriate child restraint system.

Children need adults to help protect them. They need to be properly restrained. The proper restraint depends on the child's size.

### Infants and small children

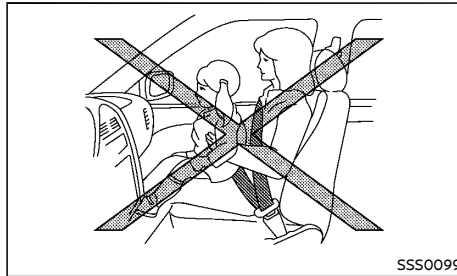

NISSAN recommends that infants and small children be seated in a child restraint system. You should choose a child restraint system that fits your vehicle and the child, and always follow the manufacturer's instructions for installation and use.

### Large children



### WARNING:

- Never allow children to stand or kneel on any seats.
- Never allow children in the luggage area while the vehicle is moving. A child could be seriously injured in an accident or sudden stop.

Children who are too large for a child restraint system should be seated and restrained by the seat belts that are provided.

If the child's seating position has a shoulder belt that fits close to the face or neck, the use of a booster seat (commercially available) may help overcome this. The booster seat should raise the child so that the shoulder belt is properly positioned across the top, middle portion of the shoulder and the lap belt is low on the hips. The booster seat should also fit the vehicle seat. Once the child has grown so that the shoulder belt is no longer on or near the face or neck of the child, use the shoulder belt without the booster seat. In addition, there are many types of child restraint systems available for larger children that should be used for maximum protection.

### PREGNANT WOMEN

NISSAN recommends that pregnant women use seat belts. The seat belt should be worn snug, and always position the lap belt as low as possible around the hips, not the waist. Place the shoulder belt over your shoulder and across your chest. Never run the lap/shoulder belt over your abdominal area. Contact your doctor for specific recommendations.



## INJURED PERSONS

NISSAN recommends that injured persons use seat belts. Contact your doctor for specific recommendations.

## THREE-POINT TYPE SEAT BELTS

### Fastening seat belts

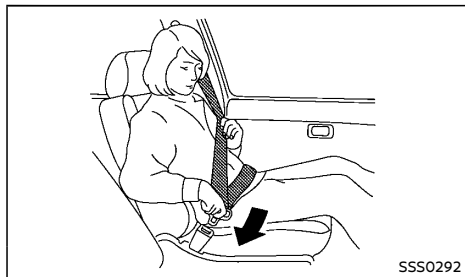

### WARNING:

**The seatback should not be in a reclined position any more than needed for comfort. Seat belts are most effective when the passenger sits well back and straight up in the seat.**

1. Adjust the seat. (See "Seats" (P.1-2).)
2. Slowly pull the seat belt out of the retractor and insert the tongue into the buckle until you hear and feel the latch engage.
  - **The retractor is designed to lock during a sudden stop or on impact. A slow pulling motion permits the belt to move, and allows you some freedom of movement in the seat.**

- **If the seat belt cannot be pulled from its fully retracted position, firmly pull the belt and release it. Then smoothly pull the belt out of the retractor.**

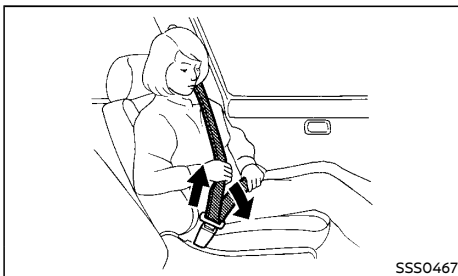

3. Position the lap belt portion low and snug on the hips as shown.
4. Pull the shoulder belt portion toward the retractor to take up extra slack. Be sure the shoulder belt is routed over your shoulder and is snug across your chest.

### Unfastening seat belts

Push the button on the buckle. The seat belt automatically retracts.

### Checking seat belt operation

Seat belt retractors are designed to lock seat belt movement:

- When the seat belt is pulled quickly from the retractor.
- When the vehicle slows down rapidly.

To increase your confidence in the seat belts, check the operation by grasping the shoulder belt and pulling forward quickly. The retractor should lock and restrict further belt movement. If the retractor does not lock during this check, contact a NISSAN dealer immediately.

## SEAT BELT MAINTENANCE

Periodically check that the seat belt and all the metal components, such as buckles, tongues, retractors, flexible wires and anchors, work properly. If loose parts, deterioration, cuts or other damage on the seat belt webbing is found, the entire seat belt assembly should be replaced.

If dirt builds up in the shoulder belt guide of the seat belt anchors, the seat belts may retract slowly. Wipe the shoulder belt guide with a clean, dry cloth.

To clean the seat belt webbing, apply a mild soap solution or any solution recommended for cleaning upholstery or carpet. Then wipe with a cloth and allow the seat belts to dry in the shade. Do not allow the seat belts to retract until they are completely dry.

## CHILD RESTRAINTS

### PRECAUTIONS ON CHILD RESTRAINT USAGE

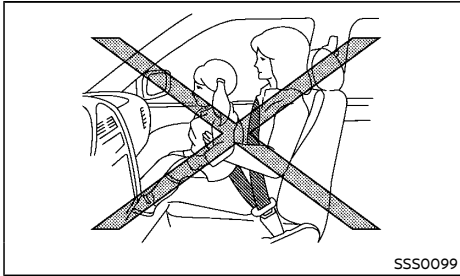

#### WARNING:

- Infants and small children should always be placed in an appropriate child restraint while riding in the vehicle. Failure to use a child restraint can result in serious injury or death.
- Infants and small children should never be carried on your lap. It is not possible for even the strongest adult to resist the forces of a severe accident. The child could be crushed between the adult and parts of the vehicle. Also, do not put the same seat belt around both your child and yourself.
- NISSAN recommends that the child restraints be installed in the rear seat. According to accident statistics, children are safer when properly restrained in the rear seat than in the front seat.
- Improper use or improper installation of a child restraint can increase the risk or severity of injury for both the child and other occupants of the vehicle and can

lead to serious injury or death in an accident.

- Follow all of the child restraint manufacturer's instructions for installation and use. When purchasing a child restraint, be sure to select one which will fit your child and vehicle. It may not be possible to properly install some types of child restraint in your vehicle.
- The direction of the child restraint, either front-facing or rear-facing, depends on the type of the child restraint and the size of the child. Refer to the child restraint manufacturer's instructions for details.
- Adjustable seatbacks should be positioned to ensure full contact between child restraint and seatback.
- After attaching a child restraint, test it before you place the child in it. Push it from side to side and tug it forward to make sure that it is held securely in place. The child restraint should not move more than 25 mm (1 in). If the restraint is not secure, tighten the belt as necessary, or install the restraint in another seat and test it again.
- When the child restraint is not in use, keep it secured with the ISOFIX child restraint system or a seat belt to prevent it from being thrown around in case of a sudden stop or accident.
- Never install a rear-facing child restraint on the front passenger's seat when the front passenger's air bag is available. Supplemental front-impact air bags inflate with great force. A rear-facing child restraint could be struck by the supplemental front-impact air bags in an accident and could seriously injure or kill your child.

- If the seat belt in the position where a child restraint is installed requires a locking device and if it is not used, injuries could result from a child restraint tipping over during normal vehicle braking or cornering.



#### CAUTION:

Remember that a child restraint left in a closed vehicle can become very hot. Check the seating surface and buckles before placing your child in a child restraint.

NISSAN recommends that infants and small children be seated in a child restraint. You should choose a child restraint that fits your vehicle and always follow the manufacturer's instructions for installation and use. In addition, there are many types of child restraints available for larger children that should be used for maximum protection.

## UNIVERSAL CHILD RESTRAINTS FOR FRONT SEAT AND REAR SEATS

### NOTE:

**Universal child restraints approved to UN Regulation No.44 (UN R44) or UN Regulation No.129 (UN R129) are clearly marked "Universal".**

When selecting any child restraint, keep the following points in mind:

- Choose a child restraint that complies with the UN R44 or UN R129.
- Place your child in the child restraint and check the various adjustments to be sure the child restraint is compatible with your child. Always follow all of the recommended procedures.
- Check the child restraint in your vehicle to be sure it is compatible with vehicle's seat belt system.
- Refer to the tables later in this section for a list of the recommended fitment positions and the approved child restraints for your vehicle.

### Mass group of child seat

Mass group	Child's weight
Group 0	up to 10 kg
Group 0+	up to 13 kg
Group I	9 to 18 kg
Group II	15 to 25 kg
Group III	22 to 36 kg

### Kind of child seats (example):

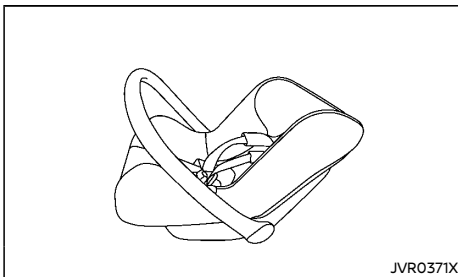

Child safety seat categories 0 and 0+

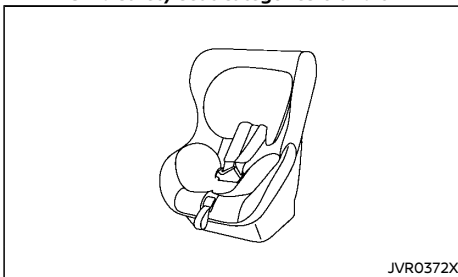

Child safety seat categories 0+ and I

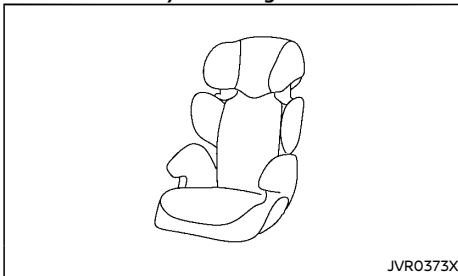

Child safety seat categories II and III

## Approved child restraint positions (without ISOFIX)

The following restriction is applied when using child restraints varying by infants weight and installation position.

Mass group		Seating position		
		Front passenger	Rear outboard seat	Rear center seat
0	<10 kg	X	U	U
0 +	<13 kg	X	U	U
I	9 - 18 kg	UF*1	U	U
II	15 - 25 kg	UF*1	UF	UF
III	22 - 36 kg	UF*1	UF	UF

U: Suitable for universal category child restraint system approved for this weight group

UF: Suitable for forward-facing universal category child restraint system approved for this weight group

X: Not suitable for child restraint system

\*1: When you install the child seat, remove the head restraint if it be interfered.

## Approved child restraint positions (with ISOFIX)

This is a regulatory table, indicating ISOFIX and semi-universally ISOFIX approved child seats for various approved seating positions.

Mass group				Seating position		
				Front passenger	Rear outboard seat	Rear center seat
Carrycot		F	ISO/L1	X	X	X
		G	ISO/L2	X	X	X
0	<10 kg	E	ISO/R1	X	IL	X
0+	<13 kg	E	ISO/R1	X	IL	X
		D	ISO/R2	X	IL	X
		C	ISO/R3	X	IL	X
I	9 - 18 kg	D	ISO/R2	X	IL	X
		C	ISO/R3	X	IL	X
		B	ISO/F2	X	IUF	X
		B1	ISO/F2X	X	IUF	X
		A	ISO/F3	X	IUF	X
II	15 - 25 kg	-	-	X	IL	X
III	22 - 36 kg	-	-	X	IL	X

X: Position not suitable for installation of ISOFIX child restraint systems (CRS) in these seating positions

IUF: Suitable for universal category forward facing child restraint system approved for this weight group

IL: Suitable for ISOFIX CRS in semi-universal category or particular ISOFIX CRS

## ISOFIX CHILD RESTRAINT SYSTEM

Your vehicle is equipped with special anchor points that are used with ISOFIX child restraint systems.

### ISOFIX lower anchor point locations

The ISOFIX anchor points are provided to install child restraints in the rear outboard seating positions only. **Do not attempt to install a child restraint in the center position using the ISOFIX anchors.**

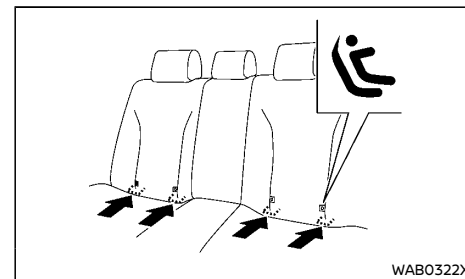

ISOFIX label location

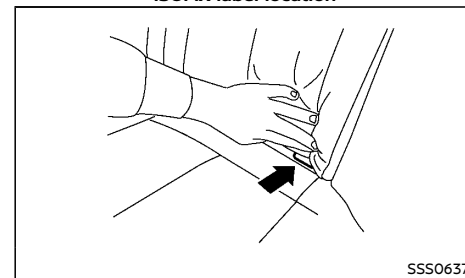

ISOFIX lower anchor location

The ISOFIX anchors are located at the rear of the seat cushion near the seatback. A label is

attached to the seatback to help you locate the ISOFIX anchors.

## CHILD RESTRAINT ANCHORAGE

Your vehicle is designed to accommodate a child restraint system on the rear seat. When installing a child restraint system, carefully read and follow the instructions in this manual and those supplied with the child restraint system.

### **WARNING:**

Child restraint anchorages are designed to withstand only those loads imposed by correctly fitted child restraints. Under no circumstances are they to be used for adult seat belts, harnesses or for attaching other items or equipment to the vehicle. Doing so could damage the child restraint anchorages. The child restraint will not be properly installed using the damaged anchorage, and a child could be seriously injured or killed in a collision.

## Anchorage location

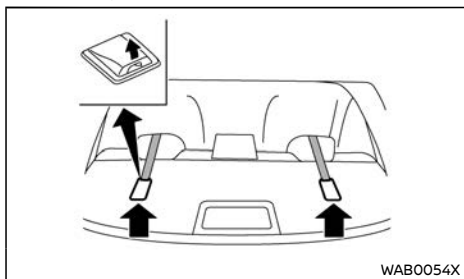

The anchor points are located on the rear parcel shelf for the right and left outboard seating positions of the rear seat.

## CHILD RESTRAINT INSTALLATION USING ISOFIX

### **WARNING:**

- **Attach ISOFIX child restraints only at the specified locations. For the ISOFIX lower anchor locations, see "ISOFIX child restraint system" (P.1-13). If a child restraint is not secured properly, your child could be seriously injured or killed in an accident.**
- **Do not install child restraints that require the use of a top tether strap to seating positions that do not have a top tether anchor.**
- **Do not secure a child restraint in the center rear seating position using the ISOFIX lower anchors. The child restraint will not be secured properly.**
- **Inspect the lower anchors by inserting your fingers into the lower anchor area and feeling to make sure there are no obstructions over the ISOFIX anchors, such as seat belt webbing or seat cushion material. The child restraint will not be secured properly if the ISOFIX anchors are obstructed.**
- **Child restraint anchorages are designed to withstand only those loads imposed by correctly fitted child restraints. Under no circumstances are they to be used for adult seat belts, harnesses or for attaching other items or equipment to the vehicle. Doing so could damage the child restraint anchorages. The child restraint will not be properly installed using the damaged anchorage, and a child could be seriously injured or killed in a collision.**

## Installation on rear outboard seats

### **Front-facing:**

Be sure to follow the manufacturer's instructions for the proper use of your child restraint. Follow these steps to install a front-facing child restraint on the rear outboard seats using ISOFIX:

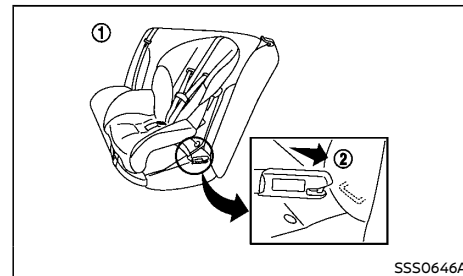

### **Front-facing: Steps 1 and 2**

1. Position the child restraint on the seat ①.
2. Secure the child restraint anchor attachments to the ISOFIX lower anchors ②.
3. The back of the child restraint should be secured against the vehicle seatback. If the seating position does not have an adjustable head restraint and it is interfering with the proper child restraint fit, try another seating position or a different child restraint.

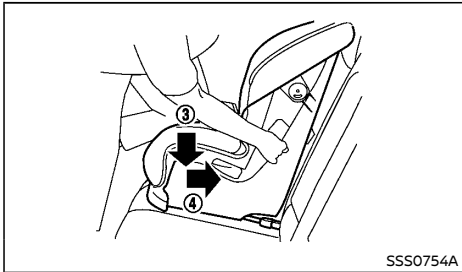

**Front-facing: Step 4**

4. Shorten the rigid attachment to have the child restraint firmly tightened; press downward ③ and rearward ④ firmly in the center of the child restraint with your knee to compress the vehicle seat cushion and seatback.
5. If the child restraint is equipped with a top tether strap, route the top tether strap and secure the tether strap to the tether anchor point. (See "Child restraint anchorage" (P.1-14).)
6. If the child restraint is equipped with other anti-rotation devices such as support legs, use them instead of the top tether strap following the child restraint manufacturer's instructions.

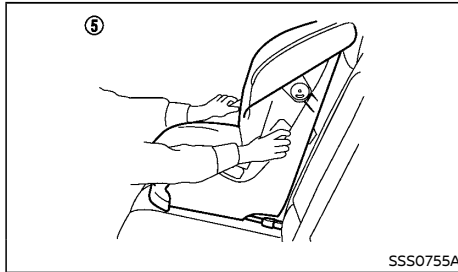

**Front-facing: Step 7**

7. Test the child restraint before you place the child in it ⑤. Push the child restraint from side to side and tug it forward to make sure that it is held securely in place.
8. Check to make sure that the child restraint is properly secured prior to each use. If the child restraint is loose, repeat steps 3 through 7.

**Rear-facing:**

Be sure to follow the manufacturer's instructions for the proper use of your child restraint. Follow these steps to install a rear-facing child restraint on the rear outboard seats using ISOFIX:

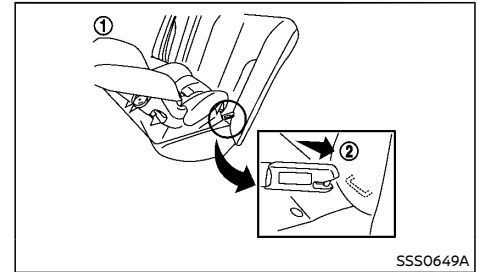

**Rear-facing: Steps 1 and 2**

1. Position the child restraint on the seat ①.
2. Secure the child restraint anchor attachments to the ISOFIX lower anchors ②.

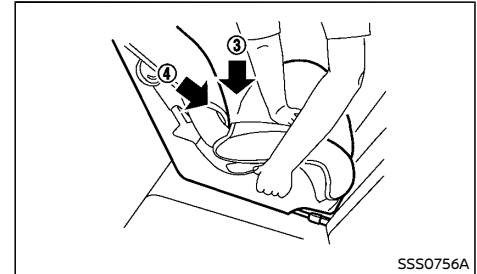

**Rear-facing: Step 3**

3. Shorten the rigid attachment to have the child restraint firmly tightened; press downward ③ and rearward ④ firmly in the center of the child restraint with your hand to compress the vehicle seat cushion and seatback.
4. If the child restraint is equipped with a top tether strap, route the top tether strap and secure the tether strap to the tether anchor point. (See "Child restraint anchorage" (P.1-14).)

- If the child restraint is equipped with other anti-rotation devices such as support legs, use them instead of the top tether strap following the child restraint manufacturer's instructions.

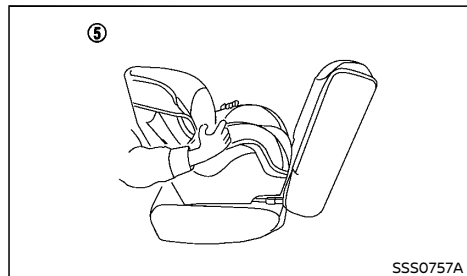

**Rear-facing: Step 6**

- Test the child restraint before you place the child in it ⑤. Push the child restraint from side to side and tug it forward to make sure that it is held securely in place.
- Check to make sure that the child restraint is properly secured prior to each use. If the child restraint is loose, repeat steps 3 through 6.

## CHILD RESTRAINT INSTALLATION USING THREE-POINT TYPE SEAT BELT

### Installation on rear seats

**Front-facing:**

Be sure to follow the manufacturer's instructions for the proper use of your child restraint. Follow these steps to install a front-facing child restraint on the rear seats using three-point type seat belt:

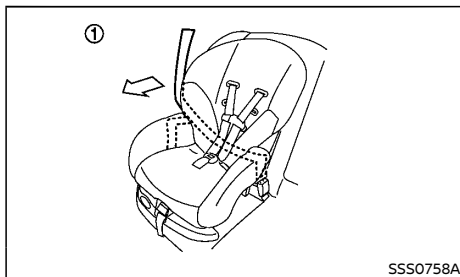

**Front-facing: Step 1**

- Position the child restraint on the seat ①. If any contact occurs between the child restraint and the front seat, slide the front seat forward until contact no longer occurs.

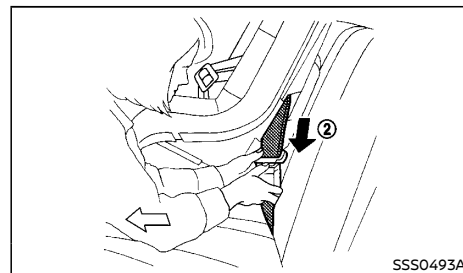

**Front-facing: Step 2**

- Route the seat belt tongue through the child restraint and insert it into the buckle ② until you hear and feel the latch engage.
- To prevent slack in the seat belt webbing, it is necessary to secure the seat belt in place with locking devices attached to the child restraint.

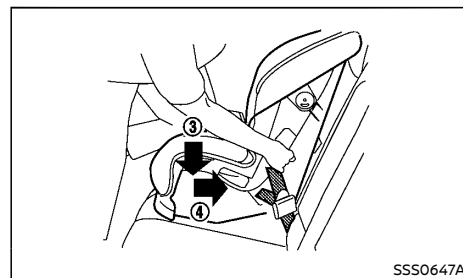

**Front-facing: Step 4**

- Remove any additional slack from the seat belt; press downward ③ and rearward ④ firmly in the center of the child restraint with your knee to compress the vehicle seat cushion and seatback while pulling up on the seat belt.



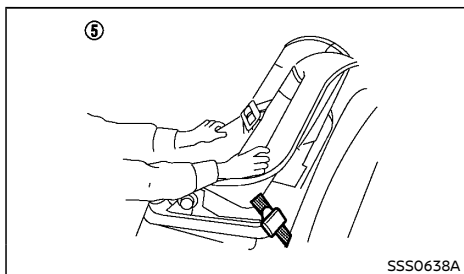

**Front-facing: Step 5**

5. Test the child restraint before you place the child in it ⑤. Push the child restraint from side to side and tug it forward to make sure that it is held securely in place.
6. Check to make sure that the child restraint is properly secured prior to each use. If the child restraint is loose, repeat steps 3 through 5.

**Rear-facing:**

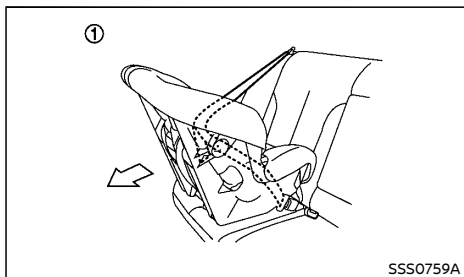

**Rear-facing: Step 1**

Be sure to follow the manufacturer's instructions for the proper use of your child restraint. Follow these steps to install a rear-facing child restraint on the rear seats using three-point

type seat belt:

1. Position the child restraint on the seat ①.

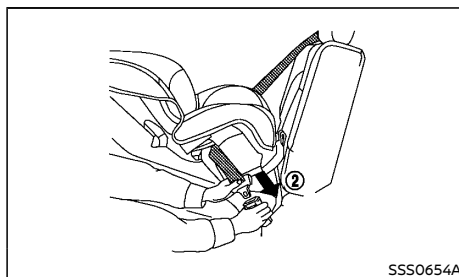

**Rear-facing: Step 2**

2. Route the seat belt tongue through the child restraint and insert it into the buckle ② until you hear and feel the latch engage.
3. To prevent slack in the seat belt webbing, it is necessary to secure the seat belt in place with locking devices attached to the child restraint.

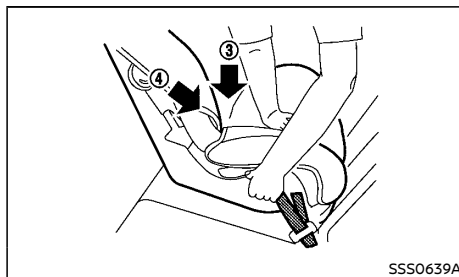

**Rear-facing: Step 4**

4. Remove any additional slack from the seat belt; press downward ③ and rearward ④ firmly in the center of the child restraint with your hand to compress the vehicle

seat cushion and seatback while pulling up on the seat belt.

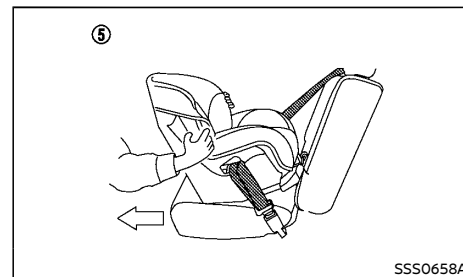

**Rear-facing: Step 5**

5. Test the child restraint before you place the child in it ⑤. Push the child restraint from side to side and tug it forward to make sure that it is held securely in place.
6. Check to make sure that the child restraint is properly secured prior to each use. If the child restraint is loose, repeat steps 3 through 5.

## Installation on front passenger's seat

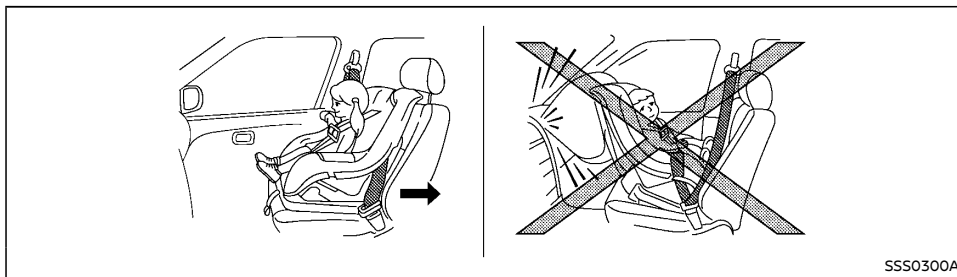

SSS0300A



### WARNING:

- Never install a rear-facing child restraint on the front passenger's seat when the front passenger's air bag is available. Supplemental front-impact air bags inflate with great force. A rear-facing child restraint could be struck by the supplemental front-impact air bags in an accident and could seriously injure or kill your child.
- Never install a child restraint with a top tether strap on the front seat.
- NISSAN recommends that a child restraint be installed on the rear seat. However, if you must install a child restraint on the front passenger's seat, move the passenger's seat to the rearmost position.
- Child restraints for infants must be used in the rear-facing direction and therefore must not be used on the front passenger's seat when the front passenger's air bag is available.

- Failure to use the seat belts will result in the child restraint not being properly secured. It could tip over or otherwise be unsecured and cause injury to the child in a sudden stop or collision.

### Front-facing:

Be sure to follow the manufacturer's instructions for the proper use of your child restraint. Follow these steps to install a front-facing child restraint on the front passenger's seat using three-point type seat belt:

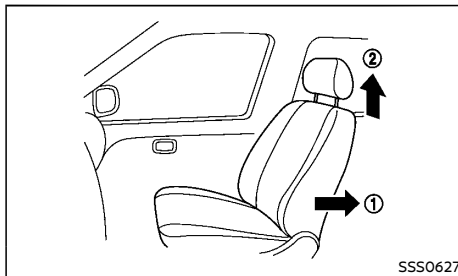

SSS0627

Front-facing: Steps 1 and 2

1. Move the seat to the rearmost position ①.
2. Remove the head restraint ②.
3. Position the child restraint in the seat.

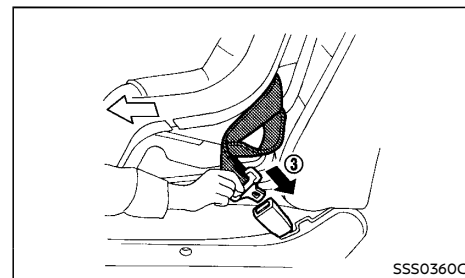

SSS0360C

### Front-facing: Step 4

4. Route the seat belt tongue through the child restraint and insert it into the buckle ③ until you hear and feel the latch engage.
5. To prevent slack in the seat belt webbing, it is necessary to secure the seat belt in place with locking devices attached to the child restraint.

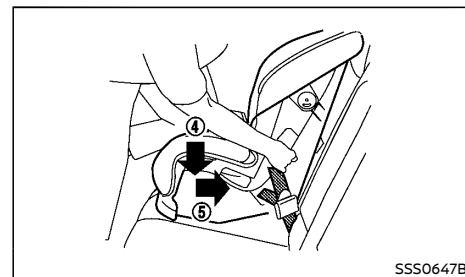

SSS0647B

### Front-facing: Step 6

6. Remove any additional slack from the seat belt; press downward ④ and rearward ⑤ firmly in the center of the child restraint

## SUPPLEMENTAL RESTRAINT SYSTEM (SRS)

with your knee to compress the vehicle seat cushion and seatback while pulling up on the seat belt.

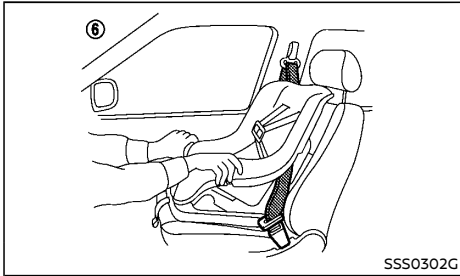

**Front-facing: Step 7**

7. Test the child restraint before you place the child in it ⑥. Push the child restraint from side to side and tug it forward to make sure that it is held securely in place.
8. Check to make sure that the child restraint is properly secured prior to each use. If the child restraint is loose, repeat steps 5 through 7.

### PRECAUTIONS ON SUPPLEMENTAL RESTRAINT SYSTEM (SRS)

This Supplemental Restraint System (SRS) section contains important information concerning the driver's and passenger's supplemental front-impact air bags, supplemental side-impact air bags and pre-tensioner seat belts.

#### Supplemental front-impact air bag system

This system can help cushion the impact force to the head and chest area of the driver and/or front passenger in certain frontal collisions. The supplemental front-impact air bag is designed to inflate on the front where the vehicle is impacted.

#### Supplemental side-impact air bag system (if equipped)

This system can help cushion the impact force to the chest and pelvis area of the driver and front passenger in certain side-impact collisions. The supplemental side-impact air bag is designed to inflate on the side where the vehicle is impacted.

#### Supplemental curtain side-impact air bag system (if equipped)

This system can help cushion the impact force to the head of the driver and passengers in front and rear outboard seating positions in certain side-impact collisions. The supplemental curtain side-impact air bag is designed to inflate on the side where the vehicle is impacted.

The SRS is designed to **supplement** the accident protection provided by the driver's and passenger's seat belts and **is not** designed to **substitute** for them. The SRS can help save

lives and reduce serious injuries. However, inflating air bags may cause abrasions or other injuries. Air bags do not provide protection to the lower body. Seat belts should always be correctly worn and the occupants should always be seated a suitable distance away from the steering wheel and instrument panel. (See "Seat belts" (P.1-6).) The air bags inflate quickly in order to help protect the occupants. The force of the air bags inflating can increase the risk of injury if the occupants are too close to, or are against, the air bag modules during inflation. The air bags will deflate quickly after deployment.

**The SRS operates only when the ignition switch is in the "ON" position.**

**When the ignition switch is in the "ON" position, the SRS air bag warning light illuminates for about 7 seconds and then turns off. This indicates that the SRS is operational. (See "SRS air bag warning light" (P.1-23).)**

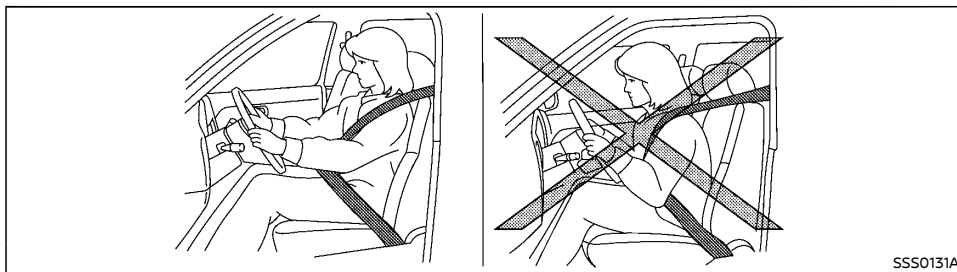

SSS0131A

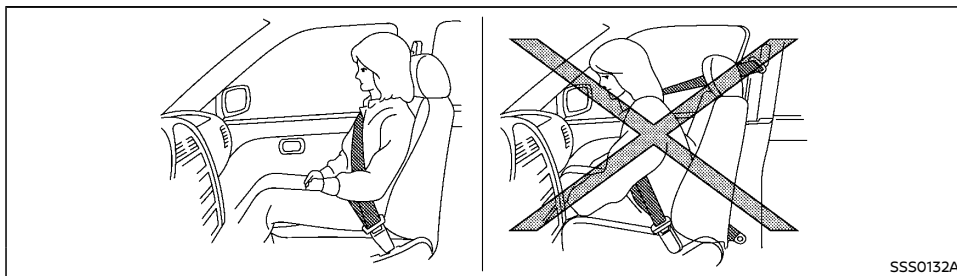

SSS0132A

if the supplemental front air bag inflates.

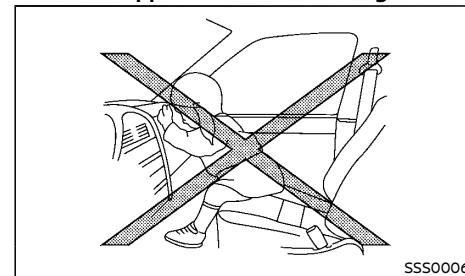

SSS0006

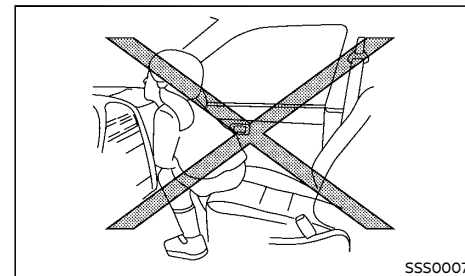

SSS0007

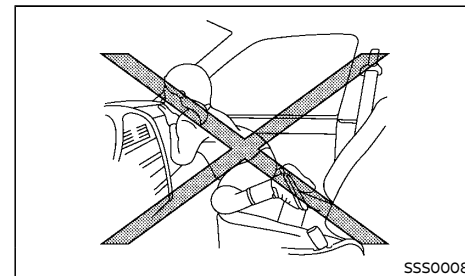

SSS0008

**WARNING:**

- The supplemental front-impact air bags ordinarily will not inflate in the event of a side impact, rear impact, rollover, or lower severity frontal collision. Always wear the seat belts to help reduce the risk or severity of injury in various kinds of accidents.
- The seat belts and the supplemental front-impact air bags are most effective when you are sitting well back and upright in the seat. The front-impact air bags inflate with great force. If you and your passengers are unrestrained, lean-

ing forward, sitting sideways, or out of position in any way, you and your passengers are at greater risk of injury or death in an accident. You and your passengers may also receive serious or fatal injuries from the supplemental front-impact air bag if you are up against it when it inflates. Always sit back against the seatback and as far away as practical from the steering wheel or instrument panel. Always use the seat belts.

- Keep hands on the outside of the steering wheel. Placing them inside the steering wheel rim could increase the risk of injury

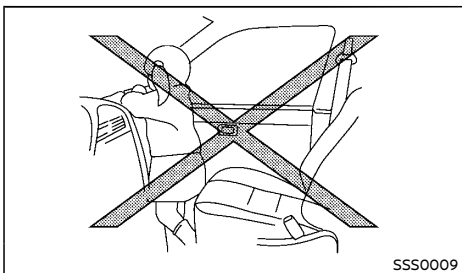

**⚠ WARNING:**

- Never let children ride unrestrained or extend their hands or face out of the window. Do not attempt to hold them in your lap or arms. Some examples of dangerous riding positions are shown in the illustrations.
- Children may be severely injured or killed when the air bags inflate if they are not properly restrained.
- Never install a rear-facing child restraint system on the front seat. An inflating supplemental front-impact air bag could seriously injure or kill your child. (See "Child restraints" (P.1-10).)

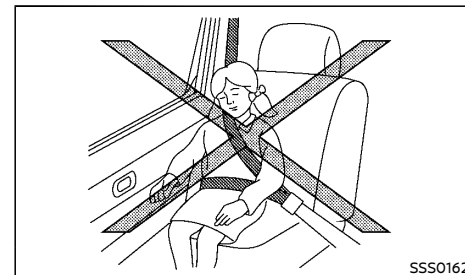
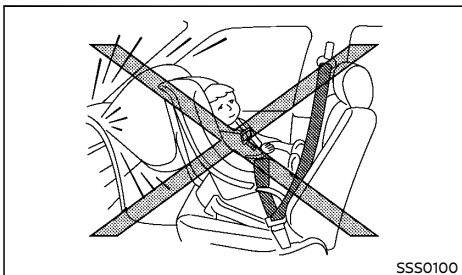
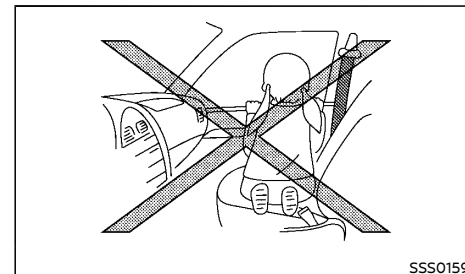
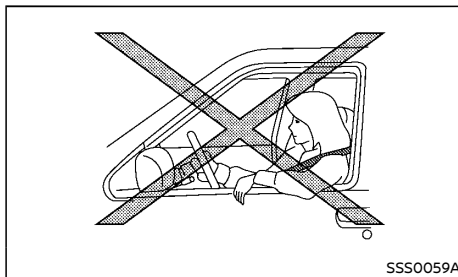
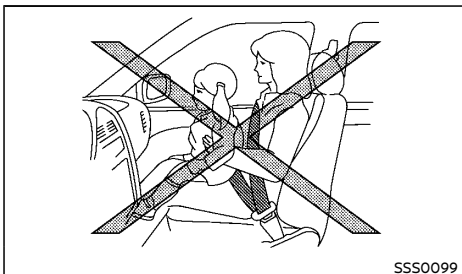
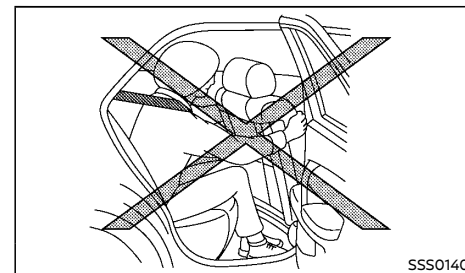

**WARNING:**

- The supplemental side-impact air bags and supplemental curtain side-impact air bags ordinarily will not inflate in the event of a front impact, rear impact, rollover, or lower severity side collision. Always wear the seat belts to help reduce the risk or severity of injury in accidents.
- The seat belts and the supplemental side-impact air bags and supplemental curtain side-impact air bags are most effective when you are sitting well back and upright in the seat. The supplemental side-impact air bags, and supplemental curtain side-impact air bags inflate with great force. If you and your passengers are unrestrained, leaning forward, sitting sideways, or out of position in any way, you and your passengers are at greater risk of injury or death in an accident.
- Do not allow anyone to place their hands, legs or face near the supplemental side-impact air bags and supplemental curtain side-impact air bags located on the sides of the seatback of the front seats or near the side roof rails. Do not allow anyone sitting in the front seats or rear outboard seats to extend their hands out of the windows or lean against the doors. Some examples of dangerous riding positions are shown in the illustrations.
- When sitting in the rear seats, do not hold onto the seatback of the front seats. If the supplemental side-impact air bags and supplemental curtain side-impact air bags inflate, you may be seriously injured. Be especially careful with children, who should always be properly restrained.

- Do not use seat covers on the front seatbacks. They may interfere with the supplemental side-impact air bag inflations.

### Pre-tensioner seat belt system

The pre-tensioner seat belt system may activate with the supplemental air bag system in certain types of collisions.

Working with the seat belt retractors and lap outer (driver's side) anchors, it helps tighten the seat belt the instant the vehicle becomes involved in certain types of collisions, helping to restrain front seat occupants. (See "Pre-tensioner seat belt system" (P.1-27).)

### Air bag warning labels

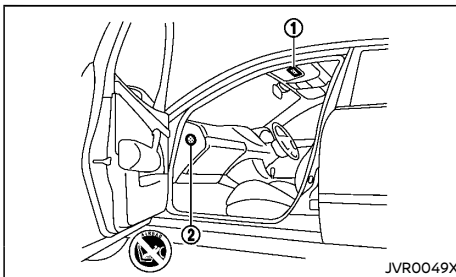

Warning labels about the supplemental air bag system are placed in the vehicle as shown in the illustration.

The warning label ① is located on the surface of the passenger's sun visor.

The warning label ② is located on the side of the passenger's side instrument panel.

The label(s) warn you not to fit a rear-facing child restraint system on the front passenger

seat as such a restraint system used in this position could cause serious injury to the infant in case of air bag deployment during a collision.



① Air bag warning label

The label ① warns:

"NEVER use a rearward facing child restraint on a seat protected by an ACTIVE AIRBAG in front of it, DEATH or SERIOUS INJURY to the CHILD can occur."

In vehicles equipped with a front-impact passenger air bag system, use a rear-facing child restraint system only on the rear seats.

When installing a child restraint system in your vehicle, always follow the child restraint system manufacturer's instructions for installation. For additional information, see "Child restraints" (P.1-10).

## SRS air bag warning light



The Supplemental Restraint System (SRS) air bag warning light, displaying  in the instrument panel, monitors the circuits for the air bag systems, pre-tensioner seat belt system and all related wiring.

When the ignition switch is in the "ON" position, the SRS air bag warning light illuminates for about 7 seconds and then turns off. This indicates that the SRS air bag systems are operational.

If any of the following conditions occur, the air bag and/or pre-tensioner seat belt systems need servicing:

- The SRS air bag warning light remains on after approximately 7 seconds.
- The SRS air bag warning light does not illuminate at all.

Under these conditions, the air bag and/or pre-tensioner seat belt systems may not operate properly. They must be checked and repaired. Contact a NISSAN dealer immediately.

## SUPPLEMENTAL AIR BAG SYSTEMS

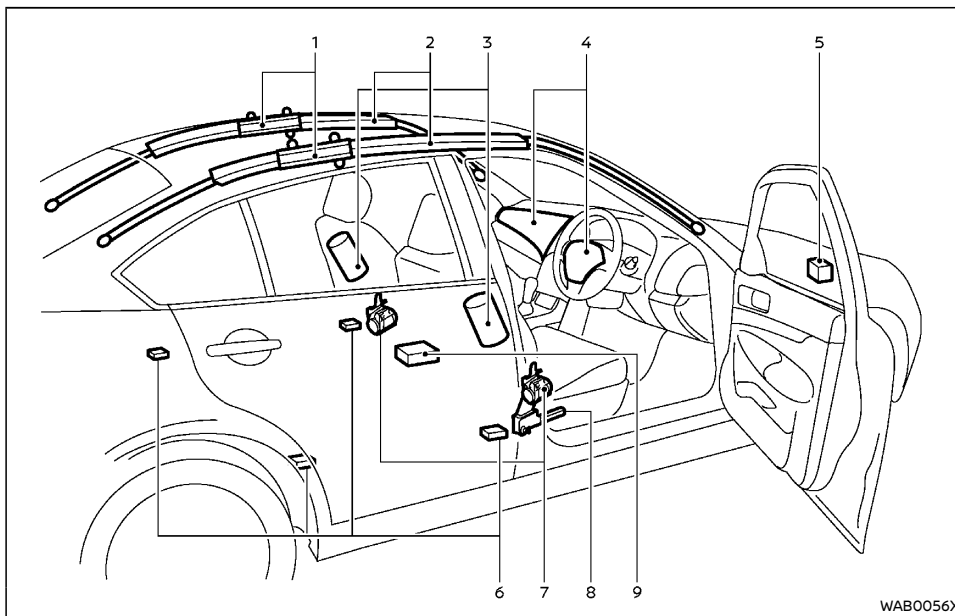

1. Supplemental curtain side-impact air bag inflators (if equipped)
2. Supplemental curtain side-impact air bag modules (if equipped)
3. Supplemental side-impact air bag modules (if equipped)
4. Supplemental front air bag modules
5. Crash zone sensor
6. Satellite sensors (if equipped)
7. Seat belt pre-tensioner retractors
8. Lap outer pre-tensioner (driver's side)
9. Air bag Control Unit (ACU)



### WARNING:

- Do not place any objects on the steering wheel pad, on the instrument panel, near the front door finishers and the front

seats. Do not place any objects between any occupants and the steering wheel pad, on the instrument panel, near the front door finishers and the front seats. Such objects may become dangerous projectiles and cause injury if a supplemental air bag inflates.

- Immediately after inflation, several supplemental air bag system components will be hot. Do not touch them: you may severely burn yourself.
- No unauthorized changes should be made to any components or wiring of the supplemental air bag systems. This is to prevent accidental inflation of the supplemental air bags or damage to the supplemental air bag systems.
- Do not make unauthorized changes to your vehicle's electrical system, suspension system, front end structure and side panels. This could affect proper operation of the supplemental air bag systems.
- Tampering with the supplemental air bag systems may result in serious personal injury. Tampering includes changes to the steering wheel and the instrument panel by placing materials over the steering wheel pad and above, around or on the instrument panel or by installing additional trim materials around the supplemental air bag systems.
- Work on and around the supplemental air bag systems should be done by a NISSAN dealer. The SRS wiring should not be modified or disconnected. Unauthorized electrical test equipment and probing devices should not be used on the supplemental air bag systems.

- The SRS wiring harness connectors are yellow and/or orange for easy identification.

When the air bags inflate, a fairly loud noise may be heard, followed by the release of smoke. This smoke is not harmful and does not indicate a fire. Care should be taken not to inhale it, as it may cause irritation and choking. Those with a history of a breathing condition should get fresh air promptly.

#### Supplemental front-impact air bag system

The driver's supplemental front-impact air bag is located at the center of the steering wheel. The passenger's supplemental front-impact air bag is located at the instrument panel above the glove box.

The supplemental front-impact air bag system is designed to inflate in higher severity frontal collisions, although it may inflate if the forces in another type of collision are similar to those of a higher severity frontal impact. It may not inflate in certain frontal collisions. Vehicle damage (or lack of it) is not always an indication of proper supplemental front-impact air bag system operation.

#### Supplemental side-impact air bag system (if equipped)

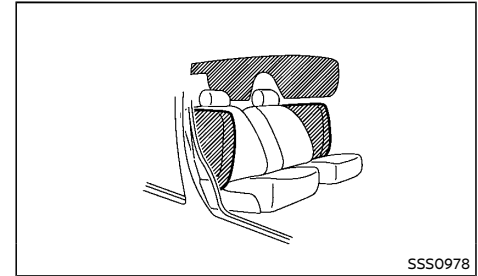

The supplemental side-impact air bag is located at the outside of the front seats' seat-backs.

The supplemental side-impact air bag system is designed to inflate in higher severity side collisions, although it may inflate if the forces in another type of collision are similar to those of a higher severity side impact. It may not inflate in certain side collisions. Vehicle damage (or lack of it) is not always an indication of proper supplemental side-impact air bag system operation.

#### Supplemental curtain side-impact air bag system (if equipped)

The supplemental curtain side-impact air bag is located at the roof rails.

The supplemental curtain side-impact air bag system is designed to inflate in higher severity side collisions, although it may inflate if the forces in another type of collision are similar to those of a higher severity side impact. It may not inflate in certain side collisions. Vehicle damage (or lack of it) is not always an indication of proper supplemental curtain side-im-



pact air bag system operation.

## SRS AIR BAG DEPLOYMENT CONDITIONS

The SRS air bags activate in the event of a front or side impact in which the vehicle occupants may be severely injured even if they are wearing the seat belts properly.

They may not activate when the crash energy is absorbed and/or distributed by the vehicle body. Vehicle damage (or lack of it) is not always an indication of proper SRS air bag system operation.

When the SRS air bag will deploy

### Supplemental front-impact air bags:

The supplemental front-impact air bag system is designed to inflate in higher severity frontal collisions. Some examples are shown in the following illustrations.

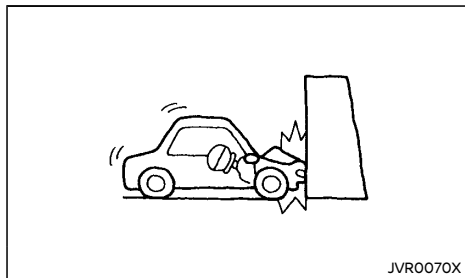

The supplemental front-impact air bag system will deploy in the event of an impact which exceeds a 25 km/h (16 MPH) frontal collision with a solid wall that does not move or deform. The supplemental front-impact air bag system may also deploy when the vehicle receives

severe damage to the undercarriage.

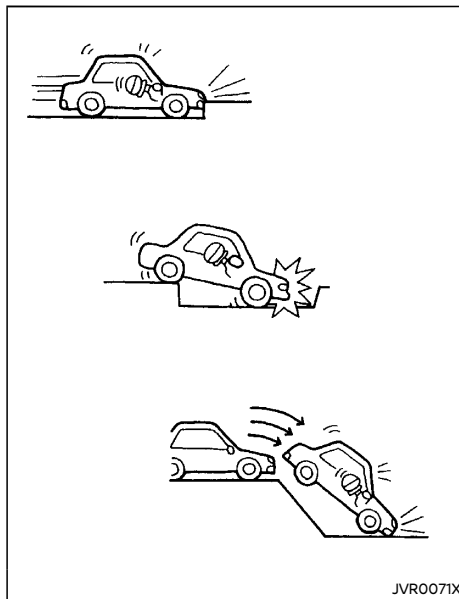

- Hitting a curb, pavement edge or hard surface at high speed
- Falling into a deep hole or ditch
- Landing hard on the ground after jumping

### Supplemental side-impact and curtain side-impact air bags (if equipped):

The supplemental side-impact and curtain side-impact air bag systems are designed to inflate in higher severity side collisions. Some examples are shown in the following illustrations.

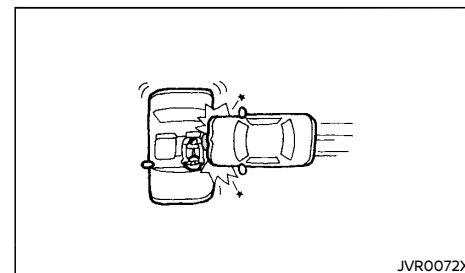

(supplemental side-impact air bag system)

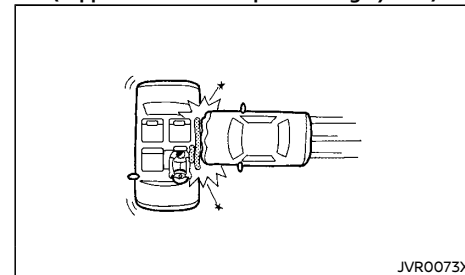

(supplemental curtain side-impact air bag system)

- The supplemental side-impact and curtain side-impact air bags will deploy in the event of a side impact with a normal passenger vehicle that exceeds at a speed of 25 km/h (16 MPH).

When the SRS air bag is unlikely to deploy

The SRS air bags may not deploy in cases where the impact is not forceful enough to inflate the SRS air bags.

For example, if the vehicle strikes an object, such as a parked vehicle or sign pole, which can move or deform on impact, the SRS air bags are unlikely to deploy.

### Supplemental front-impact air bags:

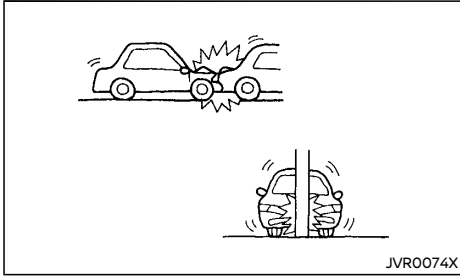

- Striking a vehicle of the same class that is parked
- Crashing into a solid utility pole

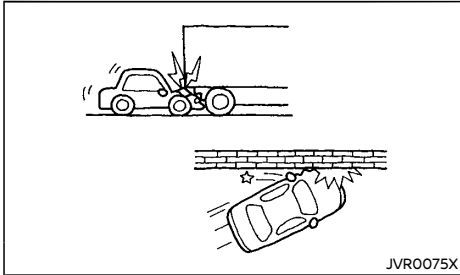

- Running under the tail gate of a truck
- A frontal offset impact to the guard rails

### Supplemental side-impact and curtain side-impact air bags (if equipped):

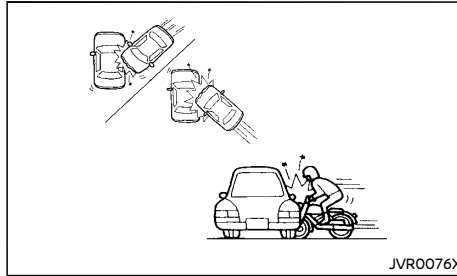

- A collision from the side at an angle
- A side impact with a two-wheeled vehicle

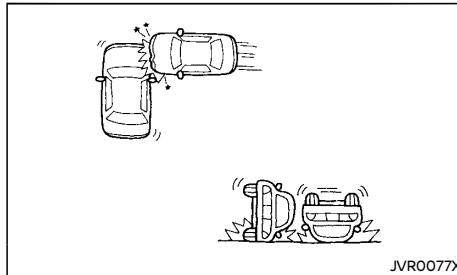

- A collision from the side impacting the vehicle engine room (trunk)
- Vehicle rollover

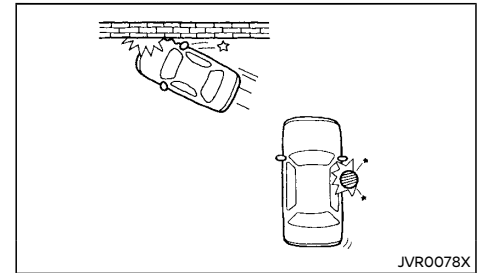

- A frontal offset impact to the guard rails
- A collision with a pole

### When the SRS air bag will not deploy

Once the SRS air bag has inflated, the air bag module will not function again if your vehicle collides with another vehicle or an object.

Other examples where the SRS air bag will not deploy are shown in the following illustrations.

### Supplemental front-impact air bags:

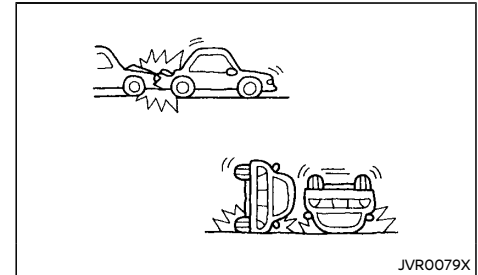

- A collision from the side or rear
- Vehicle rollover

### Supplemental side-impact and curtain side-impact air bags (if equipped):

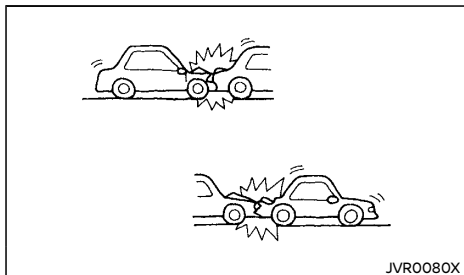

- A frontal collision with a parked or moving vehicle
- A rear collision

### PRE-TENSIONER SEAT BELT SYSTEM (if equipped)

#### **WARNING:**

- **The pre-tensioner seat belt cannot be reused after activation. It must be replaced together with the retractor and buckle as a unit.**
- If the vehicle becomes involved in a collision but the pre-tensioner is not activated, be sure to have the pre-tensioner system checked and, if necessary, replaced by a NISSAN dealer.
- No unauthorized changes should be made to any components or wiring of the pre-tensioner seat belt system. This is to prevent accidental activation of the pre-tensioner seat belt or damage to the pre-tensioner seat belt system.

- Work around or on the pre-tensioner seat belt system should be done by a NISSAN dealer. The SRS wiring should not be modified or disconnected. Unauthorized electrical test equipment and probing devices should not be used on the pre-tensioner seat belt system.
- If you need to dispose of the pre-tensioner seat belt system, or scrap the vehicle, contact a NISSAN dealer. Correct pre-tensioner disposal procedures are set forth in the appropriate NISSAN Service Manual. Incorrect disposal procedures could cause personal injury.

The pre-tensioner is encased with the front seat belt's retractor and anchor. These seat belts are used the same as conventional seat belts.

When the pre-tensioner seat belt activates, a fairly loud noise may be heard, followed by the release of smoke. This smoke is not harmful and does not indicate a fire. Care should be taken not to inhale it, as it may cause irritation and choking. Those with a history of a breathing condition should get fresh air promptly.

### REPAIR AND REPLACEMENT PROCEDURE

#### **WARNING:**

- Once the air bags have been inflated, the air bag modules will not function and must be replaced. The air bag modules must be replaced by a NISSAN dealer. The inflated air bag modules cannot be repaired.
- The air bag systems should be inspected by a NISSAN dealer if there is any damage to the front end or side portion of the

vehicle.

- If you need to dispose of the SRS or scrap the vehicle, contact a NISSAN dealer. Correct disposal procedures are set forth in the appropriate NISSAN Service Manual. Incorrect disposal procedures could cause personal injury.

The air bags and pre-tensioner seat belts are designed to activate on a one-time-only basis. As a reminder, unless the SRS air bag warning light is damaged, the SRS air bag warning light remains illuminated after inflation has occurred. The repair and replacement of the SRS should be done only by a NISSAN dealer.

When maintenance work is required on the vehicle, information about the air bags, pre-tensioner seat belts and related parts should be pointed out to the person performing the maintenance. The ignition switch should always be in the "LOCK" position when working under the hood or inside the vehicle.

**MEMO**

# 2 Instruments and controls

Cockpit .....	2-2	Trip computer .....	2-28
Left-Hand Drive (LHD) model .....	2-2	Clock and outside air temperature .....	2-30
Right-Hand Drive (RHD) model .....	2-3	Headlight and turn signal switch .....	2-30
Instrument panel .....	2-4	Headlight switch .....	2-30
Left-Hand Drive (LHD) model .....	2-4	Battery saver system .....	2-32
Right-Hand Drive (RHD) model .....	2-5	Turn signal switch .....	2-32
Meters and gauges .....	2-6	Fog light switch (if equipped) .....	2-33
Speedometer and odometer .....	2-8	Front fog lights .....	2-33
Tachometer .....	2-8	Wiper and washer switch .....	2-33
Fuel gauge .....	2-9	Windshield wiper and washer switch .....	2-33
Distance to empty (dte – km) .....	2-9	Defogger switch .....	2-34
ECO Drive Report (if equipped) .....	2-10	Horn .....	2-35
Instrument brightness control .....	2-10	Windows .....	2-35
Continuously Variable Transmission (CVT) position indicator (if equipped) .....	2-11	Power windows .....	2-35
Warning lights, indicator lights and audible reminders .....	2-12	Power outlet .....	2-37
Checking lights .....	2-13	USB (Universal Serial Bus) charging connector (if equipped) .....	2-37
Warning lights .....	2-13	Storage .....	2-38
Indicator lights .....	2-16	Glove box .....	2-38
Audible reminders .....	2-17	Console box (if equipped) .....	2-38
Vehicle information display (Type A) .....	2-18	Card holder .....	2-39
Trip computer .....	2-18	Cup holders .....	2-39
Vehicle information display (Type B) .....	2-19	Soft bottle holder .....	2-39
How to use the vehicle information display .....	2-20	Sun visors .....	2-40
Startup display .....	2-20	Interior lights .....	2-40
Settings .....	2-20	Map lights .....	2-40
Vehicle information display warnings and indicators .....	2-24	Room light .....	2-41
		Trunk light .....	2-41

## COCKPIT

### LEFT-HAND DRIVE (LHD) MODEL

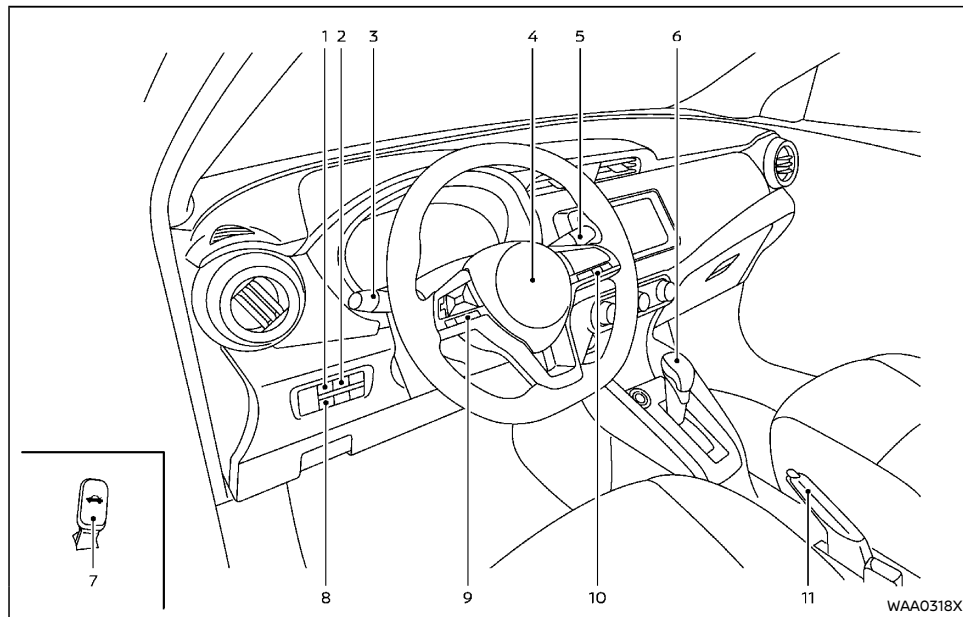

1. Trip computer mode switch\*
2. Vehicle Dynamic Control (VDC) OFF switch\*
3. Headlight, fog light\* and turn signal switch
  - Headlight and turn signal switch
  - Fog light switch\*
4. Steering wheel
  - Electric power steering
5. Wiper and washer switch
6. Shift lever
  - Continuously Variable Transmission (CVT)
  - Manual Transmission (MT)
7. Trunk lid release lever (on the driver's side floor)

8. Idling Stop OFF switch\*
  9. Steering-wheel-mounted controls (left side)\*
    - Vehicle information display control\*
    - Audio control
  10. Steering-wheel-mounted controls (right side)
    - Bluetooth® Hands-Free Phone System control
    - Smartphone voice control
  11. Parking brake
- \*: if equipped

## RIGHT-HAND DRIVE (RHD) MODEL

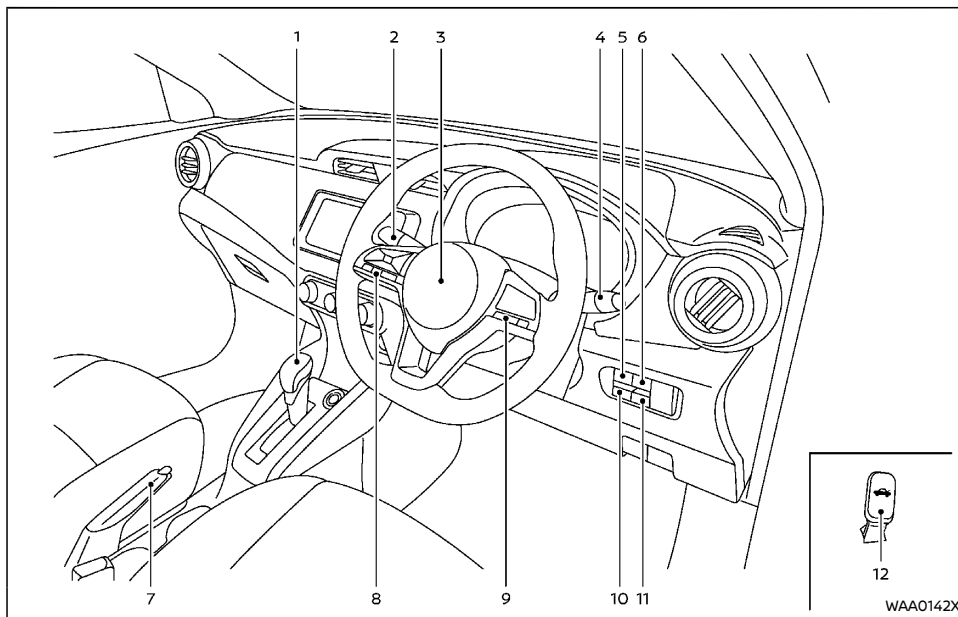

1. Shift lever
2. Wiper and washer switch
3. Steering wheel
  - Electric power steering
  - Horn
4. Headlight, fog light\* and turn signal switch
  - Headlight and turn signal switch
  - Fog light switch\*
5. Vehicle Dynamic Control (VDC) OFF switch\*
6. Trip computer mode switch\*
7. Parking brake
8. Steering-wheel-mounted controls (left side)\*
  - Vehicle information display control\*
  - Audio control
  - Bluetooth® Hands-Free Phone System
9. Steering-wheel-mounted controls (right side)
  - Bluetooth® Hands-Free Phone System control\*
  - Smartphone voice control
10. Intelligent Emergency Braking system OFF switch\*
11. Idling Stop OFF switch
12. Trunk lid release lever (on the driver's side floor)

- control\*
9. Steering-wheel-mounted controls (right side)
    - Bluetooth® Hands-Free Phone System control
    - Smartphone voice control
  10. Intelligent Emergency Braking system OFF switch\*
  11. Idling Stop OFF switch
  12. Trunk lid release lever (on the driver's side floor)
- \*: if equipped

## INSTRUMENT PANEL

### LEFT-HAND DRIVE (LHD) MODEL

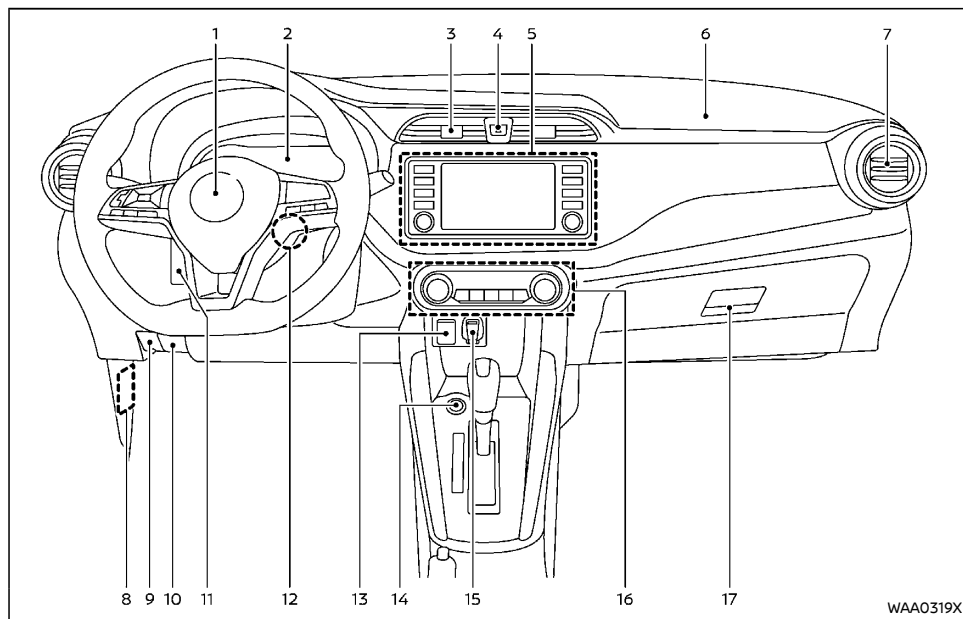

- |  |  |
|--|--|
| 1. Steering wheel<br>— Driver's front-impact air bag | 7. Side ventilator   |
| 2. Meters and gauges                                 | 8. Fuse box cover  |
| 3. Center ventilator                                 | 9. Fuel-filler lid release handle                                    |
| 4. Hazard indicator flasher switch                   | 10. Hood release handle  |
| 5. Audio system                                      | 11. Steering wheel lock lever  |
| 6. Passenger's front-impact air bag                  | 12. Ignition switch (models without Intelligent Key system)          |
|  | 13. USB (Universal Serial Bus) connection port/Auxiliary input jack* |

14. Push-button ignition switch (models with Intelligent Key system)
  15. Power outlet
  16. Heater\* and air conditioner  
— Defogger switch
  17. Glove box
- \*: if equipped



## RIGHT-HAND DRIVE (RHD) MODEL

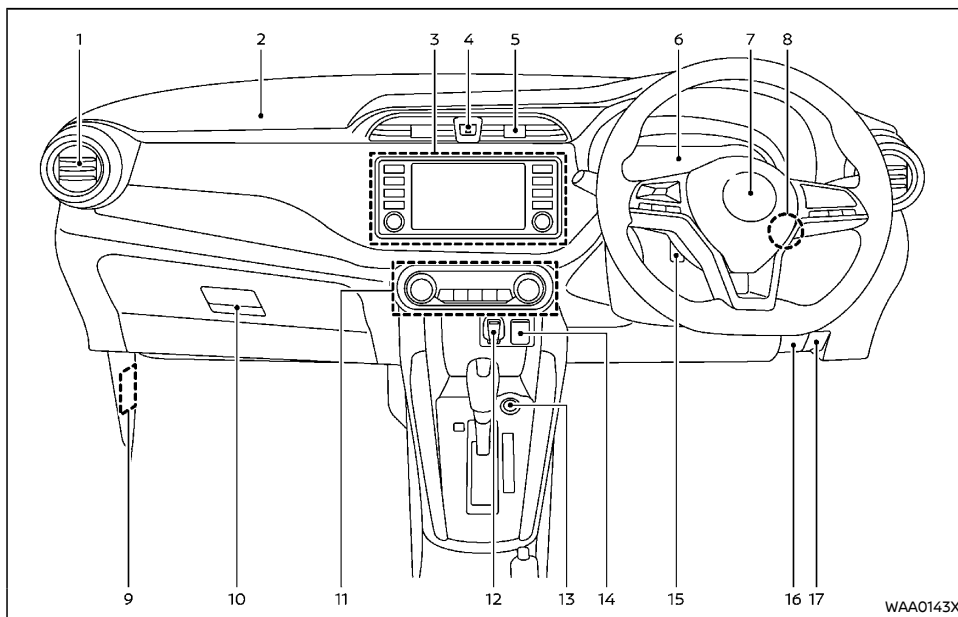

- |  |  |
|--|--|
| 1. Side ventilator                                   | 8. Ignition switch (models without Intelligent Key system)           |
| 2. Passenger's front-impact air bag                  | 9. Fuse box cover  |
| 3. Audio system                                      | 10. Glove box  |
| 4. Hazard indicator flasher switch                   | 11. Heater* and air conditioner<br>— Defogger switch                 |
| 5. Center ventilator                                 | 12. Power outlet   |
| 6. Meters and gauges                                 | 13. Push-button ignition switch (models with Intelligent Key system) |
| 7. Steering wheel<br>— Driver's front-impact air bag |  |

14. USB (Universal Serial Bus) connection port/Auxiliary input jack\*
15. Steering wheel lock lever
16. Hood release handle
17. Fuel-filler lid release handle
- \*: if equipped

## METERS AND GAUGES

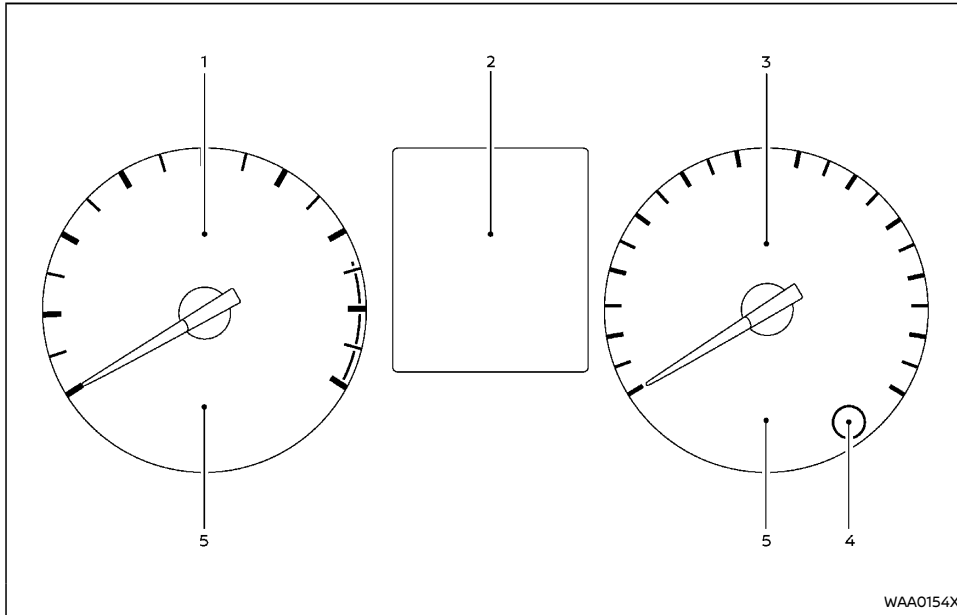

### Type A

1. Tachometer
2. Vehicle information display
  - Trip computer
  - Continuously Variable Transmission (CVT) position indicator\*
  - Odometer/twin trip odometer
  - Fuel gauge
3. Speedometer
4. Trip reset switch/Instrument brightness control knob

5. Warning and indicator lights
- \*: if equipped

**The needle indicators may move slightly after the ignition switch is placed in the "OFF" or "LOCK" position. This is not a malfunction.**

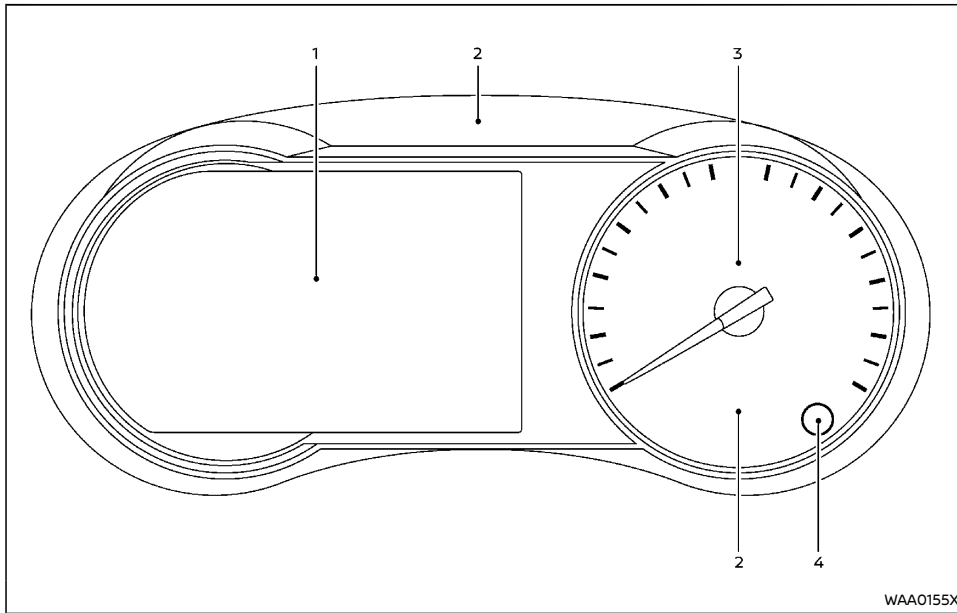

WAA0155X

**Type B**

- |   |   |
|---|---|
| <ol style="list-style-type: none"> <li>1. Vehicle information display             <ul style="list-style-type: none"> <li>– Tachometer</li> <li>– Odometer/twin trip odometer</li> <li>– Fuel gauge</li> <li>– Trip computer</li> <li>– Continuously Variable Transmission (CVT) position indicator*</li> </ul> </li> <li>2. Warning and indicator lights</li> <li>3. Speedometer</li> </ol> | <ol style="list-style-type: none"> <li>4. Trip reset switch/Instrument brightness control knob</li> </ol> <p>*: if equipped</p> |
|---|---|

## SPEEDOMETER AND ODOMETER

### Speedometer

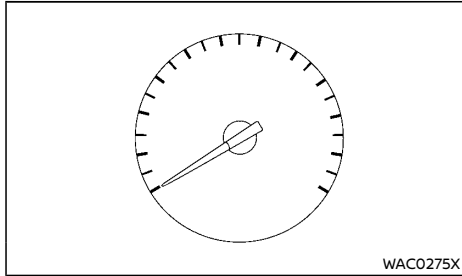

The speedometer indicates the vehicle speed.

### Odometer/Twin trip odometer

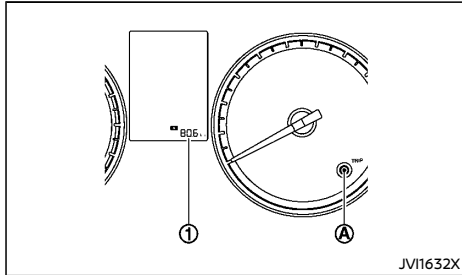

Type A

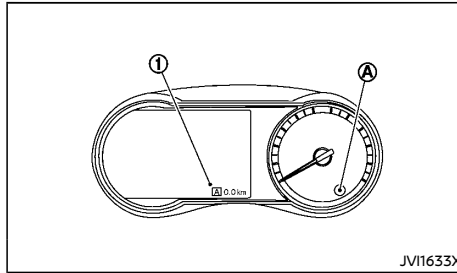

Type B

The odometer/twin trip odometer ① is displayed on the vehicle information display when the ignition switch is in the "ON" position, or is placed from the "ON" position to the "OFF" position (for Type B).

The odometer displays the total distance the vehicle has been driven.

The twin trip odometer displays the distance of individual trips.

#### Changing display:

Push the trip reset switch ④ to change the display as follows:

ODO → TRIP A → TRIP B → ODO

#### Resetting trip odometer:

Pushing the trip reset switch ④ for more than 1 second resets the currently displayed trip odometer to zero.

## TACHOMETER

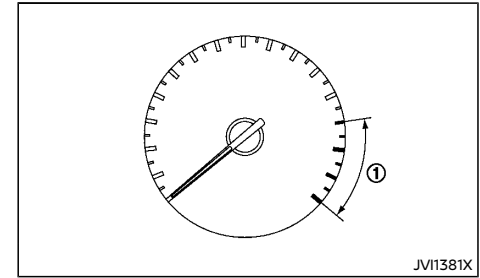

Type A

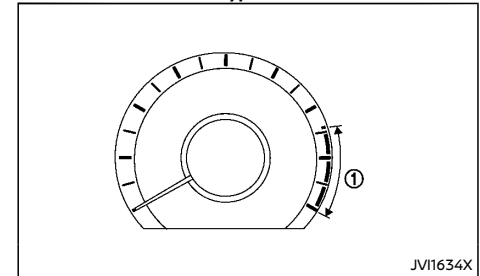

Type B

The tachometer indicates the engine speed in revolutions per minute (rpm). **Do not rev the engine into the red zone ①.**

## FUEL GAUGE

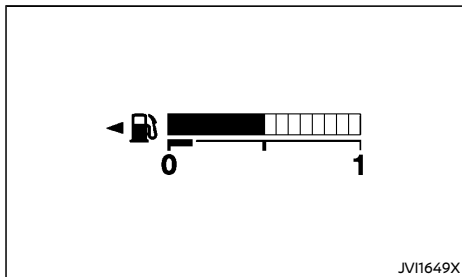

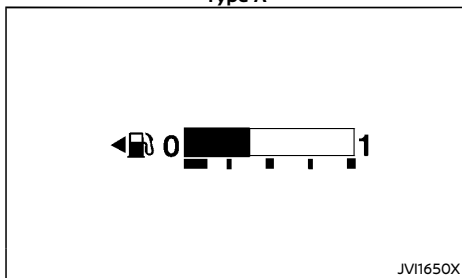

Type A



Type B

The fuel gauge indicates the approximate fuel level in the tank when the ignition switch is in the "ON" position.

The gauge may move slightly during braking, turning, accelerating, or going up and down hills due to movement of fuel in the tank.

The low fuel warning light  (if equipped) illuminates on the meter or the low fuel warning  (if equipped) appears on the vehicle information display when the fuel level in the tank is getting low. Refuel as soon as it is convenient, preferably before the gauge reads

the empty (0) position.

The arrow, , indicates that the fuel-filler lid is located on the left side of the vehicle.



### CAUTION:

**Refuel before the gauge reads 0 (empty).**

There is a small reserve of fuel in the tank when the fuel gauge reads 0 (empty).

### NOTE:

- If the fuel tank is refilled while the ignition switch is in the "ON" position, the fuel gauge may be displayed incorrectly. Refuel with the ignition switch in the "OFF" position.
- When refilling:

**Less than 10 L: the fuel gauge increases slowly, and after a few minutes, the fuel gauge will indicate the latest fuel value (approximately 1.5 min./1 segment).**

**More than 10 L: the fuel gauge increases quickly and the fuel gauge will indicate the latest fuel value.**

## DISTANCE TO EMPTY (dte – km)

### Type A

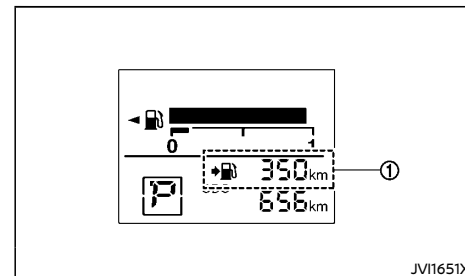

The distance to empty (dte) ① provides you with an estimation of the distance that can be driven before refueling. The dte is constantly being calculated, based on the amount of fuel in the fuel tank and the actual fuel consumption.

The display is updated every 30 seconds.

The low fuel warning light  illuminates when the fuel level in the tank is getting low.

When the fuel level drops even lower, the dte display will change to "—".

### NOTE:

- If the amount of fuel added is small (less than 10 L), the display just before the ignition switch is placed in the "OFF" position may continue to be displayed.
- When driving uphill or rounding curves, the fuel in the tank shifts, which may momentarily change the display.

## Type B

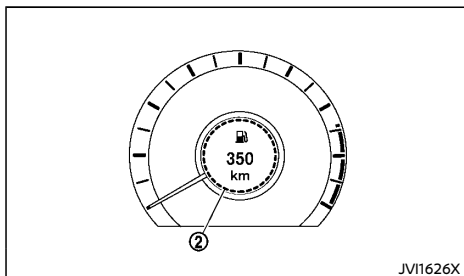
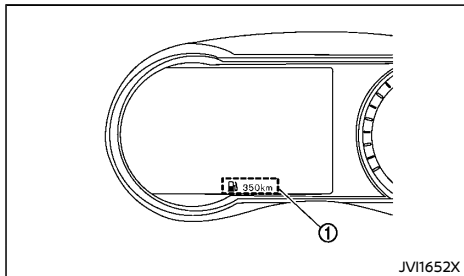

The distance to empty (dte) ① provides you with an estimation of the distance that can be driven before refueling. The dte is constantly being calculated, based on the amount of fuel in the fuel tank and the actual fuel consumption.

When the tachometer is displayed, the distance to empty (dte) appears in the tachometer ②.

The display is updated every 30 seconds.

The dte includes a low range warning feature. If the fuel level is low, the warning is displayed on the screen.

When the fuel level drops even lower, the dte display will change to "—".

### NOTE:

- If the amount of fuel added is small (less than 10 L), the display just before the ignition switch is placed in the "OFF" position may continue to be displayed.
- When driving uphill or rounding curves, the fuel in the tank shifts, which may momentarily change the display.

## ECO DRIVE REPORT (if equipped)

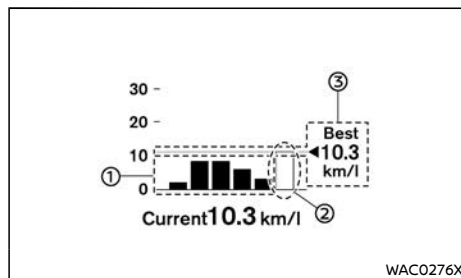

When the ignition switch is in the "OFF" position, ECO Drive Report appears.

### ① Previous 5 times (History)

The average fuel economy for the previous 5 times will be displayed.

### ② Current fuel economy

The most recent average fuel economy will be displayed.

### ③ Best fuel economy

The best fuel economy of the past history will be displayed.

The ECO Drive Report is displayed when the vehicle is driven 500 m (0.3 mi) or more and

after 30 seconds since the ignition switch was placed in the "ON" position.

You can set the ECO Drive Report not to appear when the ignition switch is in the "OFF" position. See "Customize Display" (P.2-21).

## INSTRUMENT BRIGHTNESS CONTROL

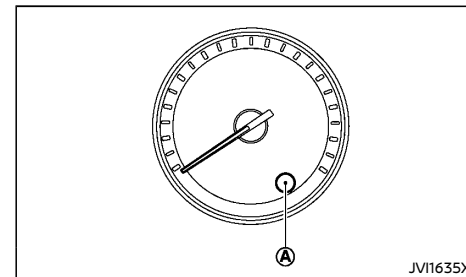

## Type A

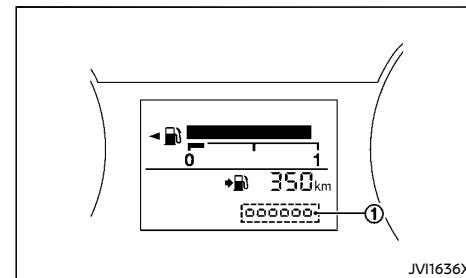

The instrument brightness control knob ① can be operated when the ignition switch is in the "ON" position and the headlight switch is on. When the control knob is operated, the vehicle information display switches to the brightness adjustment mode.

Turn the control knob clockwise to brighten the meter panel lights. Turn the control knob counterclockwise to dim the lights. The brightness indicator ① will be shown briefly in the vehicle information display when the knob is operated.

The vehicle information display returns to the normal display when the instrument brightness control knob is not operated for more than 6 seconds.

When the brightness level reaches the maximum or minimum, a beep will sound.

## Type B

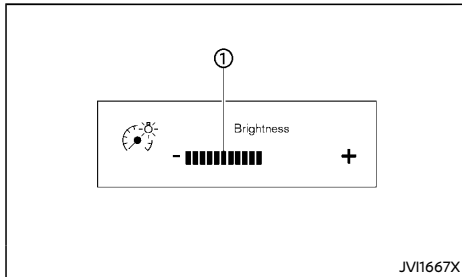

The instrument brightness control knob ① can be operated when the ignition switch is in the "ON" position. When the control knob is operated, the vehicle information display switches to the brightness adjustment mode.

Turn the control knob clockwise to brighten the meter panel lights. The bar ① moves to the + side. Turn the control knob counterclockwise to dim the lights. The bar ① moves to the - side.

























The vehicle information display returns to the normal display when the instrument brightness control knob is not operated for more than 5 seconds.

When the brightness level reaches the maximum or minimum, a beep will sound.

## CONTINUOUSLY VARIABLE TRANSMISSION (CVT) POSITION INDICATOR (if equipped)





The Continuously Variable Transmission (CVT) position indicator indicates the shift lever position when the ignition switch is in the "ON" position. (See "Vehicle information display (Type A)" (P.2-18) or "Vehicle information display (Type B)" (P.2-19).)







## WARNING LIGHTS, INDICATOR LIGHTS AND AUDIBLE REMINDERS

	Anti-lock Braking System (ABS) warning light		Low fuel warning light*		Idling Stop System indicator light*
	Brake warning light		Master warning light*		Malfunction Indicator Light (MIL)
	Charge warning light		P position selecting warning light*		Security indicator light
	Door open warning light*		Seat belt warning light		Small light indicator light
	Electric power steering warning light		Supplemental Restraint System (SRS) air bag warning light		SPORT mode indicator light*
	Engine oil pressure warning light		Vehicle Dynamic Control (VDC) warning light		Turn signals/hazard indicator lights
	High temperature warning light (red)*		Engine start operation indicator light*		Vehicle Dynamic Control (VDC) off indicator light
	Intelligent Emergency Braking system warning light*		Front fog lights indicator light*	*: if equipped	
	Intelligent Key system warning light*		High beam indicator light		



## CHECKING LIGHTS

With all doors closed, apply the parking brake, fasten the seat belts and place the ignition switch in the "ON" position without starting the engine. The following lights (if equipped) will come on: , , , , .

The following lights (if equipped) will come on briefly and then go off: , , , , ,  (red).

If any light does not come on or operates in a way other than described, it may indicate a burned-out bulb and/or a system malfunction. Have the system checked, and if necessary repaired, by a NISSAN dealer promptly.

## WARNING LIGHTS

### Anti-lock Braking System (ABS) warning light

When the ignition switch is in the "ON" position, the Anti-lock Braking System (ABS) warning light illuminates and then turns off. This indicates the ABS is operational.

If the ABS warning light illuminates while the engine is running, or while driving, it may indicate the ABS is not functioning properly. Have the system checked by a NISSAN dealer promptly.

If an ABS malfunction occurs, the anti-lock function is turned off. The brake system then operates normally, but without anti-lock assistance. (See "Anti-lock Braking System (ABS)" (P.5-41).)

### Brake warning light

#### WARNING:

- **If the brake fluid level is below the minimum mark on the brake fluid reservoir, do not drive the vehicle until the brake system has been checked by a NISSAN dealer.**
- **Even if you judge it to be safe, have your vehicle towed because driving it could be dangerous.**
- **Depressing the foot brake pedal without the engine running and/or with a low brake fluid level could increase the stopping distance and require greater pedal travel distance and effort.**

The brake warning light indicates the parking brake system operation, a low brake fluid level of the brake system and an Anti-lock Braking System (ABS) malfunction.

#### **Parking brake warning indicator:**

When the ignition switch is in the "ON" position, and the parking brake is applied, the brake warning light illuminates. When the parking brake is released, the brake warning light turns off.

If the parking brake is not fully released, the brake warning light remains on. Be sure that the brake warning light has turned off before driving. (See "Parking brake" (P.3-21).)

#### **Low brake fluid warning indicator:**

If the brake warning light illuminates while the engine is running, or while driving, and the parking brake is released, it may indicate the brake fluid level is low.

When the brake warning light illuminates while

driving, stop the vehicle safely as soon as possible. Stop the engine and check the brake fluid level. If the brake fluid level is below the minimum mark on the reservoir, add brake fluid as necessary. (See "Brake fluid" (P.8-10).)

If the brake fluid level is sufficient, have the brake system checked by a NISSAN dealer promptly.

#### **Anti-lock Braking System (ABS) warning indicator:**

When the parking brake is released and the brake fluid level is sufficient, if both the brake warning light and the Anti-lock Braking System (ABS) warning light illuminate, it may indicate the ABS is not functioning properly. Have the brake system checked, and if necessary repaired, by a NISSAN dealer promptly. (See "Anti-lock Braking System (ABS) warning light" (P.2-13).)

### Charge warning light

When the ignition switch is in the "ON" position, the charge warning light illuminates and then turns off. This indicates the charging system is operational.

If the charge warning light illuminates while the engine is running, or while driving, it may indicate the charging system is not functioning properly and may need servicing. Have the system checked by a NISSAN dealer promptly.

When the charge warning light illuminates while driving, stop the vehicle safely as soon as possible. Stop the engine and check the alternator belt. If the alternator belt is loose, broken or missing, the charging system needs repair. (See "Drive belts" (P.8-9).)

If the alternator belt appears to be functioning correctly but the charge warning light remains

illuminated, have the charging system checked by a NISSAN dealer promptly.



#### CAUTION:

**Do not continue driving if the alternator belt is loose, broken or missing.**



Door open warning light (if equipped)

When the ignition switch is in the "ON" position, the door open warning light illuminates if any of the doors is open or not closed securely.



Electric power steering warning light

When the ignition switch is in the "ON" position, the electric power steering warning light illuminates. After starting the engine, the electric power steering warning light turns off. This indicates the electric power steering is operational.

If the electric power steering warning light illuminates while the engine is running, it may indicate the electric power steering is not functioning properly and may need servicing. Have the electric power steering checked by a NISSAN dealer.

When the electric power steering warning light illuminates with the engine running, the power assist to the steering will cease operation but you will still have control of the vehicle. At this time, greater steering efforts are required to operate the steering wheel, especially in sharp turns and at low speeds.

(See "Electric power steering" (P.5-39).)



Engine oil pressure warning light

When the ignition switch is in the "ON" position, the engine oil pressure warning light illuminates. After starting the engine, the engine oil pressure warning light turns off. This indicates that the oil pressure sensors in the engine are operational.

If the engine oil pressure warning light illuminates or blinks while the engine is running, it may indicate that the engine oil pressure is low.

Stop the vehicle safely as soon as possible. Stop the engine immediately and call a NISSAN dealer.



#### CAUTION:

- **Running the engine with the engine oil pressure warning light illuminated could cause serious damage to the engine.**
- **The engine oil pressure warning light is not designed to indicate a low oil level. The oil level should be checked using the dipstick. (See "Engine oil" (P.8-7).)**



High temperature warning light (red) (if equipped)

When the ignition switch is in the "ON" position, the high temperature warning light illuminates and then turns off. This indicates that the high temperature sensor in the engine coolant system is operational.



#### CAUTION:

**If the high temperature warning light illuminates while the engine is running, it may indicate the engine temperature is extremely high. Stop the vehicle safely as soon as**

**possible.**

**If the vehicle is overheated, continuing vehicle operation may seriously damage the engine. (See "If your vehicle overheats" (P.6-12) for the immediate action required.)**



Intelligent Emergency Braking system warning light (if equipped)

When the ignition switch is in the "ON" position, the Intelligent Emergency Braking system warning light illuminates. After starting the engine, the Intelligent Emergency Braking system warning light turns off.

This light illuminates when the Intelligent Emergency Braking system is turned off or the Vehicle Dynamic Control (VDC) system is turned off.

If the light illuminates when the Intelligent Emergency Braking system is ON, it may indicate that the system is unavailable. See "Intelligent Emergency Braking system" (P.5-30) for more details.



Intelligent Key system warning light (if equipped)

After the ignition switch is placed in the "ON" position, this light comes on for about 2 seconds and then turns off.

This light illuminates or blinks as follows:

- The light blinks in yellow when the door is closed with the Intelligent Key left outside the vehicle and the ignition switch in the "ON" position. Make sure that the Intelligent Key is inside the vehicle.

- The light blinks in green when the Intelligent Key battery is running out of power. Replace the battery with a new one. See "Intelligent Key battery" (P.8-16).
- The light illuminates in yellow when it warns of a malfunction with the electrical steering lock system or the Intelligent Key system. (See "Intelligent Key system" (P.3-6).)

If the warning light illuminates in yellow while the engine is stopped, it may be impossible to free the steering lock or to start the engine. If the light comes on while the engine is running, you can drive the vehicle. However in these cases, contact a NISSAN dealer for repair as soon as possible.

#### Low fuel warning light (if equipped)

The low fuel warning light illuminates when the fuel level in the tank is getting low. Refuel as soon as it is convenient, preferably before the fuel gauge reaches the empty (0) position. There will be a small reserve of fuel remaining in the tank when the fuel gauge reaches the empty (0) position.

#### Master warning light (if equipped)

The master warning light illuminates when a warning message appears in the vehicle information display.

See "Vehicle information display (Type B)" (P.2-19).

#### P position selecting warning light (if equipped)

The warning light blinks in red when the ignition switch is pushed to stop the engine with the shift lever in any position except the "P" (Park) position.

If this warning appears, move the shift lever to the "P" (Park) position or push the ignition switch to the "ON" position.

An inside warning chime will also sound.

(See "Intelligent Key system" (P.3-6).)

#### Seat belt warning light

When the ignition switch is in the "ON" position, the seat belt warning light illuminates. The light will continue to illuminate until the driver's seat belt is fastened. (See "Seat belts" (P.1-6).)

When the vehicle speed exceeds 15 km/h (9 MPH), the light will blink and the chime will sound unless the driver's seat belt is securely fastened. The chime will continue to sound for about 90 seconds until the seat belt is fastened.

#### Supplemental Restraint System (SRS) air bag warning light

When the ignition switch is in the "ON" position, the Supplemental Restraint System (SRS) air bag warning light illuminates for about 7 seconds and then turns off. This indicates that the SRS air bag system is operational.

If any of the following conditions occur, the SRS air bag system and pre-tensioner seat belt need servicing. Have the system checked, and if necessary repaired, by a NISSAN dealer promptly.

- The SRS air bag warning light remains illuminated after about 7 seconds.
- The SRS air bag warning light does not illuminate at all.

Unless checked and repaired, the SRS air bag system and/or pre-tensioner seat belt may not function properly. (See "Supplemental Restraint System (SRS)" (P.1-19).)

#### Vehicle Dynamic Control (VDC) warning light

When the ignition switch is in the "ON" position, the Vehicle Dynamic Control (VDC) warning light illuminates and then turns off.

The warning light blinks when the VDC system is operating.

When the warning light blinks while driving, the driving condition is slippery and the vehicle's traction limit is about to be exceeded.

If the warning light illuminates when the ignition switch is placed in the "ON" position, it may indicate that the VDC or hill start assist system is not functioning properly and may need servicing. Have the system checked, and if necessary repaired, by a NISSAN dealer promptly.

If a malfunction occurs, the VDC or hill start assist function is turned off, but the vehicle is still driveable. (See "Vehicle Dynamic Control (VDC) system" (P.5-18) and "Hill start assist system" (P.5-20).)

## INDICATOR LIGHTS



Engine start operation indicator light (if equipped)

The engine start operation indicator light appears when the shift lever is in the "P" (Park) position. This light means that the engine will start by pushing the ignition switch with the brake pedal depressed. You can start the engine directly in any position of the ignition switch.



Front fog lights indicator light (if equipped)

The front fog lights indicator light illuminates when the front fog lights are on. (See "Fog light switch" (P.2-33).)



High beam indicator light

The high beam indicator light illuminates when the headlight high beam is "ON". The indicator turns off when the low beam is selected. (See "Headlight and turn signal switch" (P.2-30).)



Idling Stop System indicator light (if equipped)

The Idling Stop System indicator light illuminates when the Idling Stop System is activated.

The Idling Stop System indicator light blinks at a high speed when the engine hood is open.

The Idling Stop System indicator light blinks at a low speed, when the Idling Stop System is malfunctioning.

### NOTE:

- When the Idling Stop System indicator light blinks at a high speed (twice approximately every 1 second), be sure to check if the engine hood is open. When the engine hood is opened the engine will be in the normal stopped state. In this case, restart the engine with the ignition switch.
- When the Idling Stop System indicator light blinks at a low speed (once approximately every 2 seconds), have the system checked, and if necessary repaired, by a NISSAN dealer promptly.



Malfunction Indicator Light (MIL)



### CAUTION:

- Continuing vehicle operation without proper servicing of the engine control system could lead to poor driveability, reduced fuel economy, and damage to the engine control system, which may affect the vehicle's warranty coverage.
- Incorrect setting of the engine control system may lead to non-compliance of local and national emission laws and regulations.

When the ignition switch is in the "ON" position, the Malfunction Indicator Light (MIL) illuminates. After starting the engine, the MIL turns off. This indicates that the engine control system is operational.

If the MIL illuminates while the engine is running, it may indicate that the engine control system is not functioning properly and may need servicing. Have the vehicle checked, and if necessary repaired, by a NISSAN dealer

promptly.

If the MIL blinks (if equipped) while the engine is running, it may indicate a potential malfunction in the emission control system. In this case, the emission control system may not function properly and may need servicing. Have the system checked, and if necessary repaired, by a NISSAN dealer promptly.

To reduce or avoid possible damage to the engine control system when the MIL blinks:

- Avoid driving at speeds above 70 km/h (45 MPH).
- Avoid sudden acceleration or deceleration.
- Avoid going up steep uphill grades.
- Avoid carrying or towing unnecessary loads.



Security indicator light

The security indicator light blinks when the ignition switch is in the "LOCK" or "OFF" position. This function indicates the security system equipped on the vehicle is operational.

If security system is malfunctioning, this light will remain on while the ignition switch is in the "ON" position. (See "Security system" (P.3-15) for additional information.)



Small light indicator light

The small light indicator light illuminates when the front clearance lights, instrument panel lights, rear combination lights and license plate lights are on. The indicator light turns off when these lights are turned off.

### SPORT mode indicator light (if equipped)

The SPORT mode indicator light illuminates when the SPORT mode is turned "ON". (See "Driving with Continuously Variable Transmission (CVT)" (P.5-11) for the use of the SPORT mode switch.)

### Turn signals/hazard indicator lights

The turn signals/hazard indicator lights blink when the turn signal switch lever or hazard indicator flasher switch is "ON". (See "Headlight and turn signal switch" (P.2-30) or "Hazard indicator flasher switch" (P.6-2).)

### Vehicle Dynamic Control (VDC) off indicator light

When the ignition switch is in the "ON" position, the Vehicle Dynamic Control (VDC) off indicator light illuminates and then turns off.

The Vehicle Dynamic Control (VDC) off indicator light illuminates when the VDC system is turned off. (See "Vehicle Dynamic Control (VDC) system" (P.5-18).)

## AUDIBLE REMINDERS

### Brake pad wear warning

The disc brake pads have audible wear warnings. When a brake pad requires replacement, it will make a high pitched scraping sound when the vehicle is in motion. This scraping sound will first occur only when the brake pedal is depressed. After more wear of the brake pad, the sound will always be heard even if the brake pedal is not depressed. Have the brakes checked as soon as possible if the wear warning sound is heard.

Have the system checked, and if necessary repaired, by a NISSAN dealer promptly. (See "Brakes" (P.8-9).)

### Door lock warning chime (model with Intelligent Key)



When the chime sounds, be sure to check both the vehicle and the Intelligent Key. (See "Troubleshooting guide" (P.3-11).)

### Key reminder chime (model without Intelligent Key)

The key reminder chime will sound if the driver's side door is opened while the key is left in the ignition switch and the ignition switch is in the "OFF" or "LOCK" position.

Be sure to remove the key and carry it with you when you leave the vehicle.

### Light reminder chime

The light reminder chime will sound if the driver's door is opened while the headlight switch is in the  or  position and the ignition switch is in the "OFF" or "LOCK" position.

Be sure to turn the headlight switch to the "OFF" or "AUTO" (if equipped) position when you leave the vehicle.

### Parking brake reminder chime

The parking brake reminder chime will sound if the vehicle is driven at more than 7 km/h (4 MPH) with the parking brake applied. Stop the vehicle and release the parking brake.

### Seat belt warning chime

When the vehicle speed exceeds 15 km/h (9 MPH), the chime will sound unless the driver's seat belt is securely fastened. The chime will continue to sound for about 90 seconds until the seat belt is fastened.

### Idling Stop System reminder buzzer (if equipped)

The Idling Stop System reminder buzzer will sound if the engine hood is opened while the Idling Stop System is activated.

Be sure to check if the engine hood is open. When the engine hood is opened, the engine will be in the normal stopped state. In this case, restart the engine with the ignition switch.

## VEHICLE INFORMATION DISPLAY (Type A)

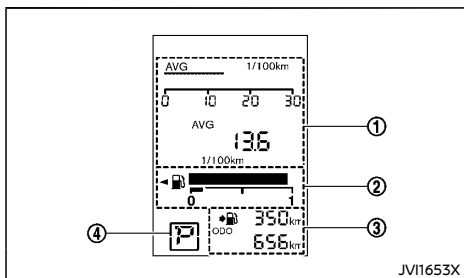

When the ignition switch is placed in the "ON" position, the vehicle information display shows the following information:

- ① Trip computer
  - "Trip computer" (P.2-18)
- ② Fuel gauge
  - "Fuel gauge" (P.2-9)
- ③ Distance to empty and Odometer/Twin trip odometer
  - "Distance to empty (dte – km)" (P.2-9)
  - "Odometer/Twin trip odometer" (P.2-8)
- ④ Continuously Variable Transmission (CVT) position indicator (if equipped)
  - "Continuously Variable Transmission (CVT) position indicator" (P.2-11)

## TRIP COMPUTER

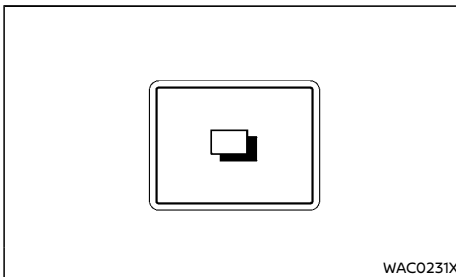

The switch for the trip computer is located on the instrument panel.

When the ignition switch is placed in the "ON" position, modes of the trip computer can be selected by pushing the  switch.

Each time the  switch is pushed, the display will change as follows:

Average fuel consumption (graph and digit) → Average fuel consumption (digit) → Average vehicle speed → Trip time → Trip distance → Average fuel consumption (graph and digit)

### Average fuel consumption (l/100km):

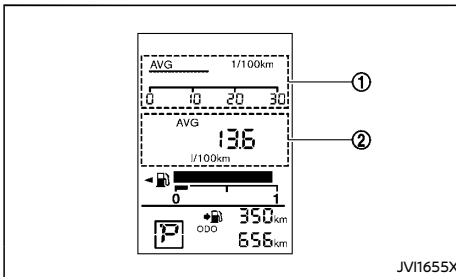



The average fuel consumption mode provides the current and average fuel consumption graphically ①. The location ② also shows the average fuel consumption. (In the digit only mode, the graph ① is not displayed.)

The average fuel consumption mode shows the average fuel consumption since the last reset. Resetting is done by pushing the  switch for longer than 1 second.

The display is updated every 30 seconds. At about the first 500 m (1/3 miles) after a reset, the display shows "----" and the digit ② is not displayed.

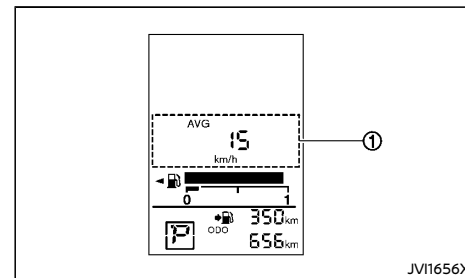
### Average vehicle speed (km/h):



The average vehicle speed mode shows the average vehicle speed ① since the last reset. Resetting is done by pushing the  switch for longer than 1 second. The display is updated every 30 seconds. The first 30 seconds after a reset, the display shows "----".

### Trip time:

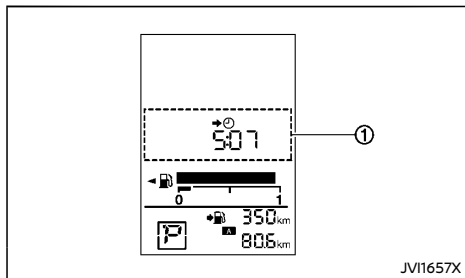

The trip time mode shows the time ① since the last reset. The displayed time can be reset by pushing the  switch for longer than 1 second.

### Trip distance (km):

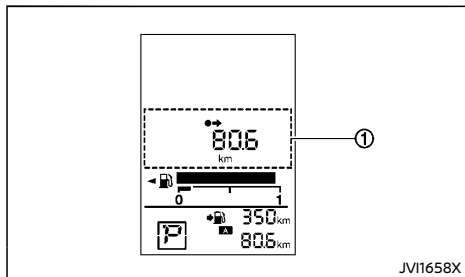

The trip distance mode shows the distance ① traveled since the last reset. The trip distance can be reset by pushing the  switch for longer than 1 second.

### Resetting displays:

Push the  switch for longer than 3 seconds. The display of average fuel consumption, average vehicle speed, trip time and trip distance will be reset at the same time.

### Extended storage fuse warning message:

The SHIP PHASE On/PUSH FUSE In warning message may be displayed if the extended storage fuse switch is not pushed in (switched on). When this message is displayed, push in (switch on) the extended storage fuse switch to turn off the message. For more information, see "Extended storage fuse switch" (P.8-18).

## VEHICLE INFORMATION DISPLAY (Type B)

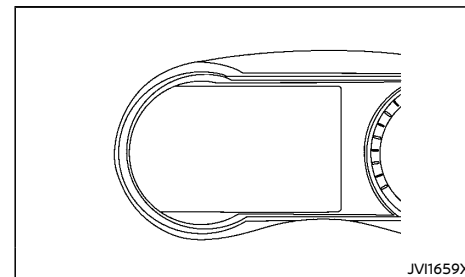

The vehicle information display is located to the left of the speedometer. It displays such items as:

- Vehicle settings
- Trip computer information
- Odometer/twin trip odometer (P.2-8)
- Distance to empty (P.2-9)
- Clock and outside temperature
- Driver Assistance
- Intelligent Key operation information
- Audio information
- Indicators and warnings
- Other information

For language settings, see "Settings" (P.2-20).

## HOW TO USE THE VEHICLE INFORMATION DISPLAY

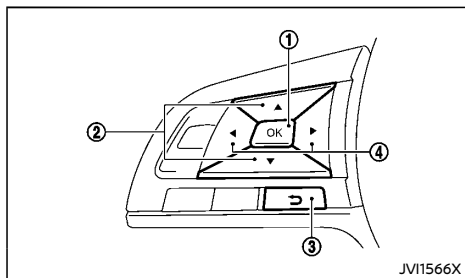

The vehicle information display can be changed using the switches OK ①,  $\blacktriangleup/\blacktriangledown$  ②,  $\blackleftarrow/\blackrightarrow$  ④, and  $\blackcurlyleftarrow$  ③ located on the steering wheel.

- ① OK - change or select an item in the vehicle information display
- ②  $\blacktriangleup/\blacktriangledown$  - navigate through the items in vehicle information display
- ③  $\blackcurlyleftarrow$  - go back to the previous menu
- ④  $\blackleftarrow/\blackrightarrow$  - change from one display screen to the previous or next screen.

The switches on the steering wheel mounted controls are also used to control audio functions. For additional information, see "Steering wheel mounted controls" (P.4-30).

## STARTUP DISPLAY

When the ignition switch is placed in the "ON" position, the screens that appear in the vehicle information display include:

- Tachometer
- Audio
- Fuel economy
- Drive computer
- Warnings
- Settings

Warnings will only appear if there are any present. For more information on warnings and indicators, see "Vehicle information display warnings and indicators" (P.2-24).

To control what items are displayed in the vehicle information display, see "Customize Display" (P.2-21).

## SETTINGS

The settings mode allows the customer to change the information displayed in the vehicle information display:

- VDC Setting
- Driver Assistance
- Customize Display
- Vehicle Settings
- Maintenance
- Clock
- Unit/Language
- Factory Reset

## VDC Setting

To change the setting, use the  $\blacktriangleup/\blacktriangledown$  switch ② to select and push OK ①.

-  System  
This allows you to turn the Vehicle Dynamic Control (VDC) system ON or OFF. By default the VDC system will be turned ON. If the VDC system is turned off, the VDC OFF indicator light will illuminate.

### NOTE:

**The vehicle should be driven with the Vehicle Dynamic Control (VDC) system ON for most driving conditions. (See "Vehicle Dynamic Control (VDC) system" (P.5-18).)**

## Driver Assistance

To change the status, warnings or turn on or off any of the systems/warnings displayed in the "Driver Assistance" menu, use the  $\blacktriangleup/\blacktriangledown$  switch ② to select and push OK ① to change a menu item.

### Blind Spot (if equipped):

This setting allows the customer to enable/disable the Blind Spot Warning (BSW) system.

Use the  $\blacktriangleup/\blacktriangledown$  switch ② to select and push OK ① to change a menu item:

- Blind Spot Warning  
Push OK ① to turn the Blind Spot Warning (BSW) system ON/OFF.
- Side Indicator Brightness  
– Bright/Standard/Dark

For additional information, see "Blind Spot Warning (BSW)" (P.5-20).



### Emergency Brake (if equipped):

This setting allows the customer to enable/disable the Intelligent Emergency Braking system.

- Front  
Push OK ① to turn the Intelligent Emergency Braking system ON/OFF.

For additional information, see "Intelligent Emergency Braking system" (P.5-30).

### Parking Aids:

This setting allows the customer to enable/disable the parking aids settings.

Use the  switch ② to select "Parking Aids" and push OK ①.

### Moving Object

Use the  switch ② to select "Moving Object" and push OK ① to turn ON/OFF the Moving Object Detection (MOD) system.

### Cross Traffic (if equipped)

This setting allows the customer to enable/disable the Rear Cross Traffic Alert (RCTA) system.

Use the  switch ② to select "Cross Traffic" and push OK ① to turn ON/OFF the Rear Cross Traffic Alert system.

### Timer Alert:

This setting allows the customer to set an alert to notify the driver that the set time has been reached.

Use the  switch ② to select "Timer Alert" and push OK ①. The following submenus appear:

- ---min / ---min
- Reset

To change the timer amount, use the  switch ② and push OK ① to save the selected

time amount.

### Low Temperature Alert:

This setting allows the customer to enable/disable the alert for low outside temperature in the vehicle information display.

Use the  switch ② to select "Low Temperature Alert" and push OK ① to turn ON/OFF the alert.

### Customize Display

The Customize Display allows the customer to choose from the various meter selections.

The Customize Display can be changed using the  ② and the OK ① switches.

### Main Menu Selection:

The items that appear when the ignition switch is placed in the "ON" position can be enabled/disabled. To change the items that are displayed, use the  switch ② to scroll and OK ① to select a menu item.

You must select at least one item.

### ECO Info Settings:

This setting allows the customer to change the ECO information settings.

Use the  switch ② to select "ECO Info Settings" and push OK ①.

### ECO Drive Report

This setting allows the customer to enable/disable the ECO Drive Report in the vehicle information display.

1. Use the  switch ② to select "ECO Drive Report".
2. Push OK ① to turn ON/OFF the ECO Drive Report.

### View History

This setting allows the customer to display the ECO Drive history and to reset the View History.

### Welcome Effect:

The welcome screen display can be turned ON/OFF to display when the ignition switch is placed in the "ON" position. To enable/disable the welcome screen:

Select "Welcome Effect" using the  switch ② and push OK ①.

### Gauges

1. Use the  switch ② to select "Gauges".
2. Push OK ① to turn ON/OFF the dial effect in the welcome screen display.

### Animation

1. Use the  switch ② to select "Animation".
2. Push OK ① to turn ON/OFF the display effect in the welcome screen display.

### Vehicle Settings

The Vehicle Settings allows the customer to change settings for the following settings.

- Lighting
- Turn Indicator
- Locking
- Wipers
- Mirrors (if equipped)

The Vehicle Settings can be changed using the  ② and the OK ① switches.

### Lighting:

The "Lighting" menu has the following options:

### Welcome Headlight

The welcome lighting can be set to be ON or OFF. Use the  ② and the OK ① switches to select an item. The following submenus are

available:

- Welcome & Farewell
  - ON/OFF
- Welcome
  - ON/OFF
- Farewell
  - ON/OFF
- OFF
  - ON/OFF

### Auto Room Lamp

The interior light timer can be set to be ON or OFF. Use OK ① to turn this feature ON or OFF.

### Light Sensitivity (if equipped)

The sensitivity of the automatic headlights can be adjusted. From the "Lighting" menu, select "Light Sensitivity". Use the  ② and the OK ① switches to select the desired sensitivity. The following options are available:

- Turn on earliest.
- Turn on earlier.
- Turn on standard.
- Turn on later.

### Turn Indicator:

The "Turn Indicator" menu has the following item:

### 3 Flash Pass

The "3 Flash Pass" overtaking feature can be set to be ON or OFF. Use OK ① to turn this feature ON or OFF.

### Locking:

The "Locking" menu has the following options:

### Ext. Door Switch

When this item is turned on, the request switch on the door is activated. Use OK ① to activate or deactivate this function.

### Wipers:

The "Wipers" menu has the following item:

### Speed Dependent

The "Speed Dependent" feature can be activated or deactivated. Use OK ① to turn this feature ON or OFF.

### Mirrors (if equipped):

The "Mirrors" menu has the following options:

### Auto Fold Off

When this item is turned on, the auto fold feature for the outside rearview mirrors is disabled. Use OK ① to turn this feature ON or OFF.

### Unfold at Ignition

When this item is turned on, the auto fold feature for the outside rearview mirrors is enabled. The outside rearview mirrors automatically unfold when the ignition switch is placed in the "ON" position or when the engine is started. Use OK ① to turn this feature ON or OFF.

### Unfold at Unlock

When this item is turned on, the auto fold feature for the outside rearview mirrors is enabled. The outside rearview mirrors automatically unfold when the vehicles doors are unlocked with the Intelligent Key or the request switch. The outside rearview mirrors also unfold when the ignition switch is placed in the "ON" position or when the engine is started. Use OK ① to turn this feature ON or OFF.

For additional information, see "Outside rearview mirrors" (P.3-20).

## Maintenance

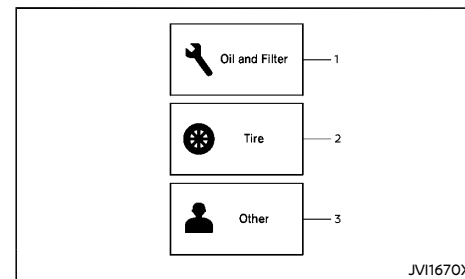

The maintenance mode allows the customer to set alerts for the following items.

1. Oil and Filter
2. Tire
3. Other

To change an item, select "Maintenance" using the  switch ② and push OK ①.

### Oil and Filter:

This indicator appears when the customer set distance comes for changing the engine oil and filter. You can set or reset the distance for checking or replacing these items. For scheduled maintenance items and intervals, see a separate maintenance booklet.

### Tire:

This indicator appears when the customer set distance comes for replacing tires. You can set or reset the distance for replacing tires.



### WARNING:

The tire replacement indicator is not a substitute for regular tire checks, including tire pressure checks. See "Changing tires and







wheels" (P.8-25). Many factors including tire inflation, alignment, driving habits and road conditions affect tire wear and when tires should be replaced. Setting the tire replacement indicator for a certain driving distance does not mean your tires will last that long. Use the tire replacement indicator as a guide only and always perform regular tire checks. Failure to perform regular tire checks, including tire pressure checks could result in tire failure. Serious vehicle damage could occur and may lead to a collision, which could result in serious personal injury or death.

#### Other:

This indicator appears when the customer set distance comes for checking or replacing maintenance items other than the engine oil, oil filter and tires. Other maintenance items can include such things as air filter or tire rotation. You can set or reset the distance for checking or replacing the items.

#### Clock

##### Set Clock Manually:

The clock setting can be changed using the  ,    and the OK  switches.



##### Clock Format:

The time setting can be selected from 12 hour and 24 hour formats.

#### Unit/Language

The unit and language that are shown in the vehicle information display can be changed:

- Mileage/Fuel
- Temperature
- Language



Use the   and the OK  switches to select "Unit/Language" and change the units of the

vehicle information display.

##### Mileage/Fuel:

The unit for the mileage that is shown in the vehicle information display can be changed to:

- km, km/l
- km, l/100km
- miles, MPG (US)
- miles, MPG (UK)

Use the   and the OK  switches to select and change the unit.

##### Temperature:

The temperature that is shown in the vehicle information display can be changed from:



- °C
- °F

Use the OK switch  to select and change the unit.

##### Language:





The language of the vehicle information display can be changed to:

- English
- Thai

Use the   and the OK  switches to select and change the language of the vehicle information display. The language of the audio display can be changed independently of the vehicle information display. See the separate NissanConnect Owner's Manual.

#### Factory Reset

The settings in the vehicle information display can be reset back to the factory default. To reset the vehicle information display:

1. Select "Factory Reset" using the  switch  and push OK .
2. Select "Yes" to return all settings back to default by pushing OK .

## VEHICLE INFORMATION DISPLAY WARNINGS AND INDICATORS

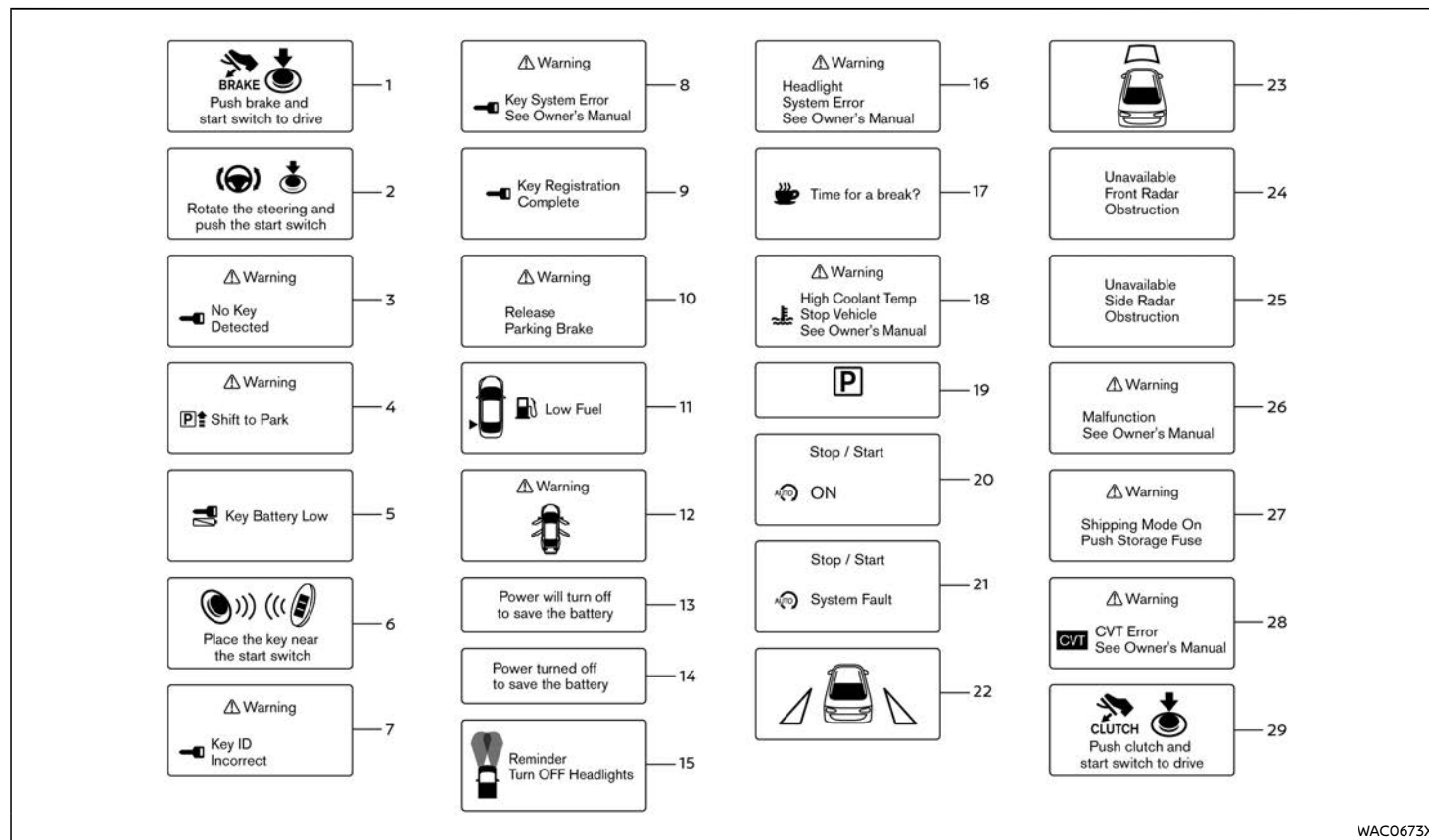

WAC0673X

Depending on the warnings and indicators, you need to push the OK switch ① located on the steering wheel to turn off the message.

#### 1. Engine start operation indicator (Continuously Variable Transmission model)

This indicator appears when the shift lever is in the "P" (Park) position.

This indicator means that the engine will start by pushing the ignition switch with the brake pedal depressed. You can start the engine directly in any position of the ignition switch.

#### 2. Steering lock release malfunction indicator

This indicator appears when the steering lock cannot be released.

If this indicator appears, push the ignition switch while lightly turning the steering wheel right and left. See "Steering lock" (P.5-8).

#### 3. No Key Detected warning

This warning appears when the door is closed with the Intelligent Key left outside the vehicle and the ignition switch in the "ON" position. Make sure that the Intelligent Key is inside the vehicle.

See "Intelligent Key system" (P.3-6) for more details.

#### 4. Shift to Park warning (if equipped)

This warning appears when the ignition switch is pushed to stop the engine with the shift lever in any position except the "P" (Park) position.

If this warning appears, move the shift lever to the "P" (Park) position or place the ignition switch in the "ON" position.

An inside warning chime will also sound. (See "Intelligent Key system" (P.3-6).)

#### 5. Key Battery Low warning

This warning appears when the Intelligent Key battery is running out of power.

If this warning appears, replace the battery with a new one. See "Intelligent Key battery" (P.8-16).

#### 6. Engine start operation for Intelligent Key system indicator

This indicator appears when the Intelligent Key battery is running out of power and when the Intelligent Key system and vehicle are not communicating normally.

If this indicator appears, touch the ignition switch with the Intelligent Key while depressing the brake pedal. (See "Intelligent Key battery discharge" (P.5-9).)

#### 7. Key ID Incorrect warning

This warning appears when the ignition switch is pushed from the "LOCK" position and the Intelligent Key cannot be recognized by the system. You cannot start the engine with an unregistered key. Use the registered Intelligent Key.

See "Intelligent Key system" (P.3-6).

#### 8. Key System Error warning

This warning appears if there is a malfunction in the Intelligent Key system.

If this warning appears while the engine is stopped, the engine cannot be started. If this warning appears while the engine is running, the vehicle can be driven. However, contact a NISSAN dealer for repair as soon as possible.

#### 9. Key Registration Complete indicator (if equipped)

This indicator appears when a new Intelligent Key is registered to the vehicle.

#### 10. Release parking brake warning

This warning appears when the vehicle speed is above 7 km/h (4 MPH) and the parking brake is applied. Stop the vehicle and release the parking brake.

#### 11. Low Fuel warning

This warning appears when the fuel level in the tank is getting low. Refuel as soon as it is convenient, preferably before the fuel gauge reaches the empty (0) position.

**There is a small reserve of fuel remaining in the tank when the fuel gauge reaches the empty (0) position.**

#### 12. Door and Trunk open warning

This warning appears if any of the doors and/or the trunk are open or not closed securely. The vehicle icon indicates which door or the trunk is open on the display.

#### 13. Power will turn off to save the battery warning

This warning appears after a period of time if the ignition switch is in the "ON" position and if the shift lever is in the "P" (Park) position (Continuously Variable Transmission model) or "N" (Neutral) position (Manual Transmission model). For additional information, see "Ignition switch positions" (P.5-8).

#### 14. Power turned off to save the battery warning

This warning appears after the ignition switch is automatically turned "OFF" to save the battery. For additional information, "Ignition switch positions" (P.5-8).

#### 15. Reminder Turn OFF Headlights warning

This warning appears when the driver side door is opened with the headlight switch left ON and the ignition switch placed in the "OFF" or "LOCK" position. Turn the headlight switch to the "OFF" or "AUTO" (if equipped) position. For additional information, see "Headlight and turn signal switch" (P.2-30).

#### 16. Headlight System Error warning

This warning appears if the LED headlights are malfunctioning. Have the system checked by a NISSAN dealer.

#### 17. Alarm - Time for a break?

This indicator appears when the set time is reached. You can set the time for up to 6 hours. See "Settings" (P.2-20).

#### 18. High Coolant Temp warning

This warning appears when the engine coolant temperature is extremely high.



#### CAUTION:

- **If the High Coolant Temp warning appears when the ignition switch is in the "ON" position, stop the vehicle safely as soon as possible.**
- **If the vehicle is overheated, continuing vehicle operation may seriously damage the engine. (See "If your vehicle overheats" (P.6-12) for the immediate action required.)**

#### 19. Continuously Variable Transmission (CVT) position indicator (if equipped)

This indicator shows the shift lever position when the ignition switch is in the "ON" position. See "Driving with Continuously Variable Transmission (CVT)" (P.5-11) for further details.

#### 20. Stop/Start - Idling Stop System indicator (if equipped)

This indicator shows the Idling Stop System status. See "Idling Stop System" (P.5-15).

#### 21. Stop/Start - System Fault warning (if equipped)

This warning appears if the Idling Stop System is malfunctioning.

Have the system checked by a NISSAN dealer.

#### 22. Blind Spot Warning (BSW) indicator (if equipped)

This indicator shows the status of the Blind Spot Warning (BSW) system.

The status is shown by the color.

See "Blind Spot Warning (BSW)" (P.5-20).

#### 23. Intelligent Emergency Braking system indicator (if equipped)

This indicator shows the status of the Intelligent Emergency Braking system.

The status is shown by the color.

See "Intelligent Emergency Braking system" (P.5-30).

#### 24. Unavailable Front Radar Obstruction warning (if equipped)

This message appears when the Intelligent Emergency Braking system becomes unavailable because the front radar is obstructed. For additional information, see "Intelligent Emergency Braking system" (P.5-30).

#### 25. Unavailable Side Radar Obstruction warning (if equipped)

This warning appears when the Blind Spot Warning (BSW) and Rear Cross Traffic Alert systems are not functioning properly. The radar sensors may be blocked by temporary ambient conditions such as splashing water, mist or fog.

These systems are not available until the conditions no longer exist. See "Blind Spot Warning (BSW)" (P.5-20) and "Rear Cross Traffic Alert (RCTA)" (P.5-26).

#### 26. Malfunction warning

This warning appears when the following systems are not functioning properly.

- Blind Spot Warning (BSW) system (if equipped)
- Rear Cross Traffic Alert system (if equipped)
- Intelligent Emergency Braking system (if equipped)

For additional information, see "Blind Spot Warning (BSW)" (P.5-20), "Rear Cross Traffic Alert (RCTA)" (P.5-26) and "Intelligent Emergency Braking system" (P.5-30).

## 27. Shipping Mode On Push Storage Fuse warning (if equipped)

This warning may appear if the extended storage fuse switch is not pushed in (switched on). When this warning appears, push in (switch on) the extended storage fuse switch to turn off the warning. For more information, see "Extended storage fuse switch" (P.8-18).

## 28. CVT Error warning (if equipped)

This warning appears when there is a malfunction with the Continuously Variable Transmission (CVT) system. If this warning appears, have the system checked by a NISSAN dealer.

## 29. Engine start operation indicator (Manual Transmission models)

This indicator means that the engine will start by pushing the ignition switch with the clutch pedal depressed. You can start the engine directly in any position of the ignition switch.

You can also start the engine by pushing the ignition switch with the brake pedal depressed when the shift lever is in the "N" (Neutral) position.

## TRIP COMPUTER

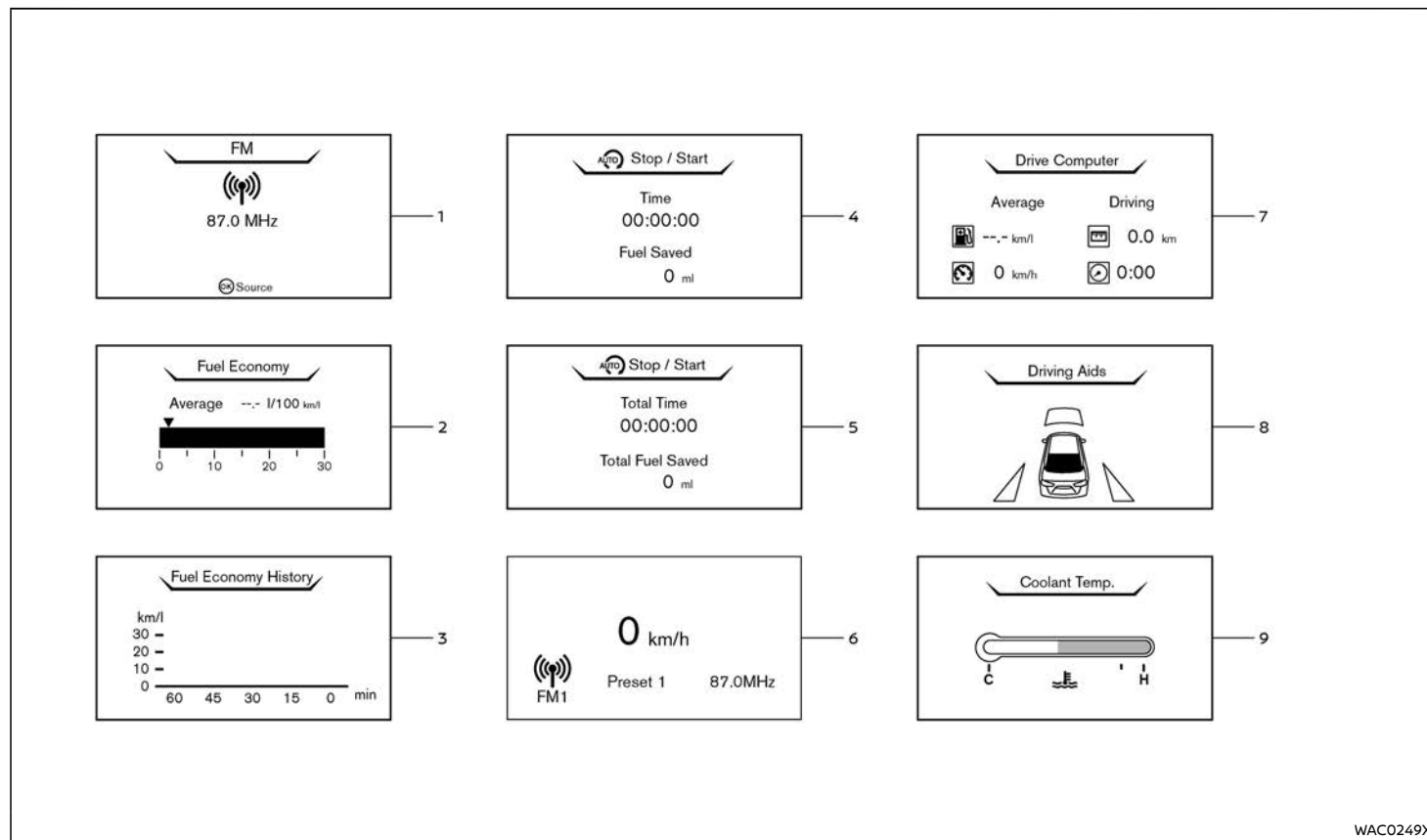

WAC0249X



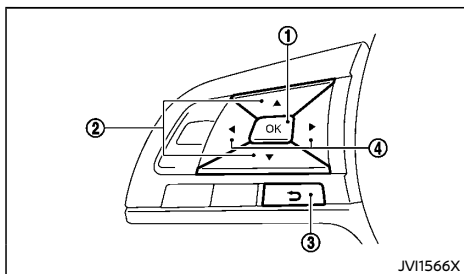

The trip computer display can be changed using the switches located on the left side of the steering wheel.

- ① OK - change or select an item in the vehicle information display
- ② - navigate through the items in vehicle information display
- ③ - go back to the previous menu
- ④ - change from one display screen to the previous or next screen

## 1. Audio

The audio mode shows the status of audio information.

## 2. Fuel Economy

The average fuel consumption mode shows the average fuel consumption since the last reset.

Resetting is done by pushing the OK switch ①. When the OK switch is pushed, the following menu items are displayed.

- Cancel
  - Return to the previous screen without resetting.

- Yes
  - Reset the fuel economy.

The display is updated every 30 seconds. For about the first 500 m (1/3 mile) after a reset, the display shows "—".

## 3. Fuel Economy History

The Fuel Economy indicated by bar graph is updated every 5 minutes.

The Fuel Economy from the past 1 hour is displayed.

## 4-5. Idling Stop System (if equipped)

The Idling Stop System mode shows the fuel savings and the engine stop time. (See "Idling Stop System" (P.5-15).)

### Trip fuel saved and engine stop time:

The trip fuel saved and engine stop time mode shows the amount of fuel saved and the engine stop time since the ignition switch was placed in the "ON" position.

- Cancel
  - Return to the previous screen without resetting.
- Yes
  - Reset the fuel saved and engine stop time.

### Total fuel saved and engine stop time:

The total fuel saved and engine stop time mode shows the amount of fuel saved and the engine stop time since the last reset.

Resetting is done by pushing the OK switch ①. When the OK switch is pushed, the following menu items are displayed.

- Cancel

- Return to the previous screen without resetting.

- Yes
  - Reset the fuel saved and engine stop time.

## 6. Status

This mode shows vehicle speed and audio information.

## 7. Drive Computer

The Drive Computer mode shows the following information.

- Average fuel consumption
- Average speed
- Trip odometer
- Elapsed time

### Average fuel consumption (l (liter)/100 km or km/l (liter)):

The average fuel consumption mode shows the average fuel consumption since the last reset.

The display is updated every 30 seconds. For about the first 500 m (1/3 mile) after a reset, the display shows "—".

### Average speed (km/h):

The average speed mode shows the average vehicle speed since the last reset.

The display is updated every 30 seconds. The first 30 seconds after a reset, the display shows "—".

### Trip odometer (km):

The trip odometer mode shows the total distance the vehicle has been driven since the last reset.

### Elapsed time:

The elapsed time mode shows the time since the last reset.

### Reset Menu:

The drive computer information can be reset item by item or all at once.

To reset each item or all items:

1. Push OK ① to switch to the reset menu.
2. Select one item to be reset or the "Reset All" key using the  $\blacktriangle$  switch ② and push OK ①.
3. Select "Yes" to reset the item(s) by pushing OK ①.

## 8. Driving Aids

The Driving Aids mode shows the operating condition for the following systems.

- Blind Spot Warning (BSW) (if equipped)
  - Intelligent Emergency Braking (if equipped)
- For more details, see "Blind Spot Warning (BSW)" (P.5-20) and "Intelligent Emergency Braking system" (P.5-30).

## 9. Coolant Temp.

Allows the customer to turn the coolant temp. screen on or off in the vehicle information display.

The engine coolant temperature gauge indicates the engine coolant temperature.

## CLOCK AND OUTSIDE AIR TEMPERATURE

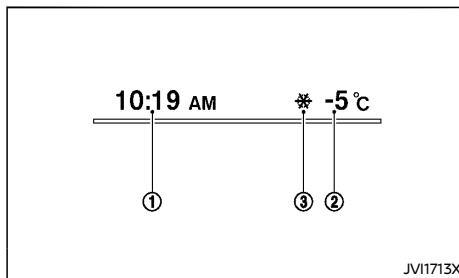

The clock ① and outside air temperature ② are displayed on the upper side of the vehicle information display.

### Clock

For clock adjustment, see "Settings" (P.2-20) or separate NissanConnect Owner's Manual.

### Outside air temperature (°C or °F)

The outside air temperature is displayed in °C or °F in the range of -40 to 60°C (-40 to 140°F).

The outside air temperature mode includes a low temperature warning feature. If the outside air temperature is below 3°C (37°F), the warning ③ is displayed on the screen.

The outside temperature sensor is located in front of the radiator. The sensor may be affected by road or engine heat, wind directions and other driving conditions. The display may differ from the actual outside temperature or the temperature displayed on various signs or billboards.

## HEADLIGHT AND TURN SIGNAL SWITCH

### HEADLIGHT SWITCH

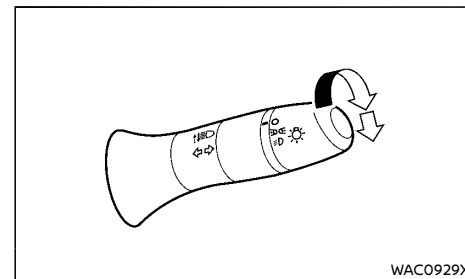

Type A

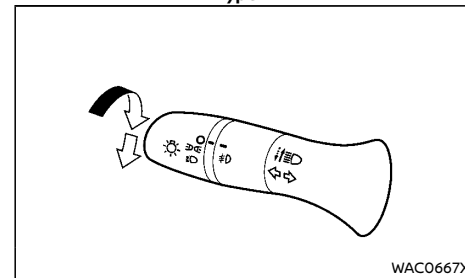

Type B

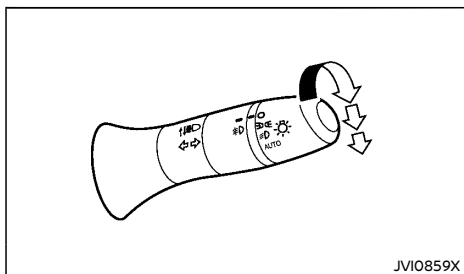

Type C

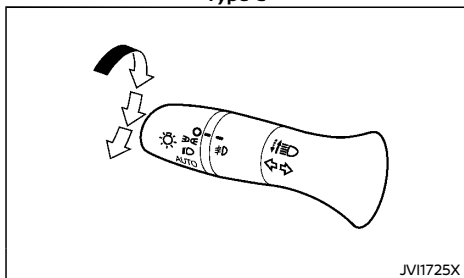

Type D

NISSAN recommends that you consult the local regulations concerning the use of lights.

### ☀️ position

The ☀️ position turns on the front clearance lights, instrument panel lights, rear combination lights and other lights.

### ☞ position

The ☞ position turns on the headlights in addition to the other lights.

### AUTO position (if equipped)

When the ignition switch is in the "ON" position and the headlight switch is in the "AUTO" position, the headlights, front clearance lights, instrument panel lights, rear combination lights and other lights turn on automatically depending on the brightness of the surroundings.

When the ignition switch is placed in the "LOCK" or "OFF" position, the lights will turn off automatically.

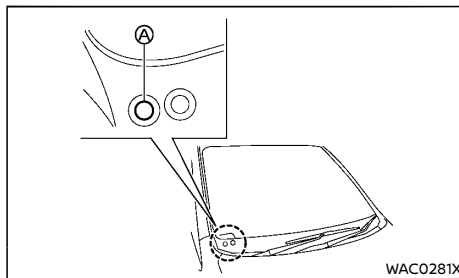

### CAUTION:

**Do not place any objects on top of the sensor** Ⓐ. **The sensor senses the brightness level and controls the autolight function. If the sensor is covered, it reacts as if it is dark, and the headlights will illuminate.**

\* The layout in the illustration shows that of the Right-Hand Drive (RHD) model. For the Left-Hand Drive (LHD) model, the layout will be the opposite.

### Headlight beam

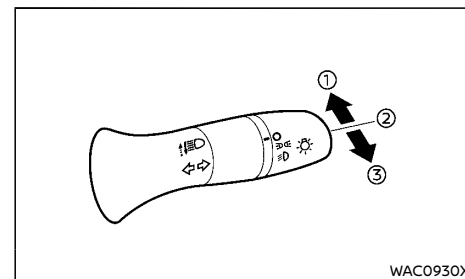

Type A (example)

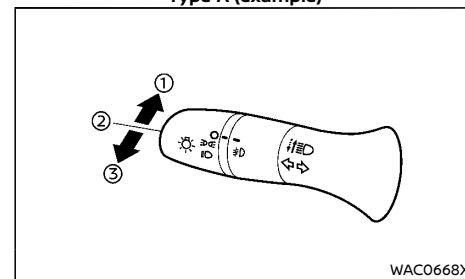

Type B (example)

To turn on the high beam, push the lever towards the front position ①.

To turn off the high beam, return the lever to the neutral position ②.

To flash the headlights, pull the lever towards the rearmost position ③. The headlights can be flashed even when the headlights are not on.

## Daytime running light system (if equipped)

Even if the headlight switch is in the OFF position, the daytime running lights will come on after starting the engine.

When the headlight switch is turned to the OFF or AUTO position, the daytime running light will turn off.

## BATTERY SAVER SYSTEM

The light reminder chime will sound if the driver's door is opened while the following operation is found:

- The headlight switch is in either the OFF or AUTO position, and the ignition switch is in the "OFF" or "LOCK" position.

Be sure to turn the headlight switch to the "OFF" or "AUTO" (if equipped) position when you leave the vehicle.

If the ignition switch is placed in the "OFF" or "LOCK" position while the headlight switch is in the OFF or AUTO position, the battery saver function will turn off the lights after a period of time to prevent the battery from being discharged.



### CAUTION:

**Do not leave the lights on when the engine is not running for extended periods of time to prevent the battery from being discharged.**

## TURN SIGNAL SWITCH

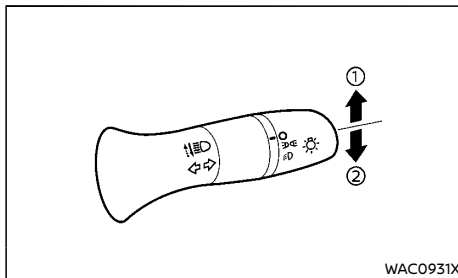

WAC0931X

Type A (example)

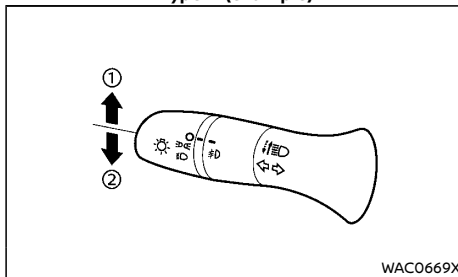

WAC0669X

Type B (example)



### CAUTION:

**The turn signal switch will not be cancelled automatically if the steering wheel turning angle does not exceed the preset amount. After the turn or lane change, make sure that the turn signal switch is returned to its original position.**

## Turn signal

To turn on the turn signals, move the lever up ① or down ② towards the desired direction. When the turn is completed, the turn signal cancels automatically.

## Lane change signal

To turn on the lane change signals, move the lever up ① or down ② towards the desired direction.

To cancel the flashing, move the lever to the opposite direction.

If the lever is moved back right after moving up ① or down ②, the light will flash 3 times.

## FOG LIGHT SWITCH (if equipped)

### FRONT FOG LIGHTS

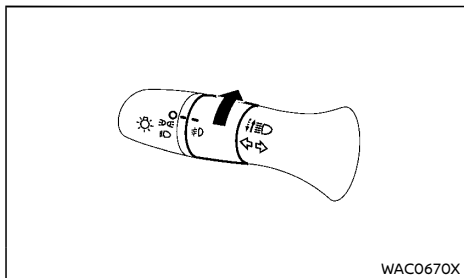

Type A

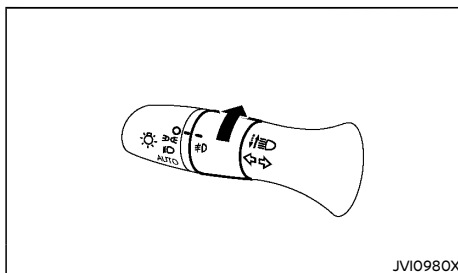

Type C

To turn on the front fog lights, turn the fog light switch to the 雾灯 (fog light) position with the headlight switch in the 大灯 (high beam) or 小灯 (low beam) position.

To turn the fog lights on with the headlight switch in the "AUTO" position (if equipped), the headlights must be on, then turn the fog light switch to the 雾灯 (fog light) position.

To turn off the fog lights, turn the fog light switch to the "OFF" position.

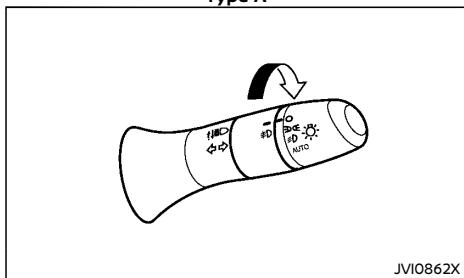

Type B

## WIPER AND WASHER SWITCH

### WARNING:

In freezing temperatures, the washer fluid may freeze on the windshield and obscure your vision. Warm the windshield with the defogger before you wash the windshield.

### CAUTION:

- Do not operate the washer continuously for longer than 30 seconds.
- Do not operate the washer if the window washer fluid reservoir is empty.
- If the wiper operation is interrupted by snow or ice, the wiper may stop moving to protect its motor. If this occurs, turn the wiper switch to the "OFF" position and remove the snow or ice on and around the wiper arms. In approximately 1 minute, turn the switch on again to operate the wiper.

## WINDSHIELD WIPER AND WASHER SWITCH

The windshield wiper and washer operate when the ignition switch is in the "ON" position.

## Wiper operation

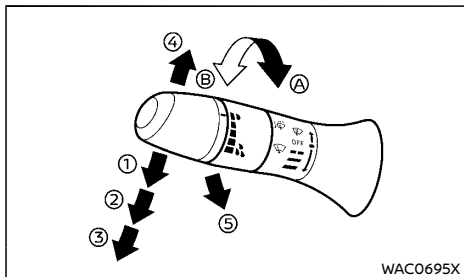

Type A

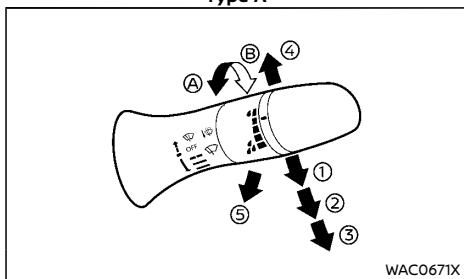

Type B

The lever position  ① operates the wiper intermittently.

- The intermittent operation can be adjusted by turning the adjustment control knob, (longer) (A) or (shorter) (B).
- The speed of the intermittent operation varies depending on the vehicle speed.

The lever position  ② operates the wiper at low speed.

The lever position  ③ operates the wiper at high speed.

To stop the wiper operation, move the lever up to the "OFF" position.

The lever position  ④ operates the wiper for one sweep. The lever automatically returns to its original position.

## Washer operation

To operate the washer, pull the lever toward the back of the vehicle  ⑤ until the desired amount of washer fluid is spread on the windshield. The wiper will automatically operate several times.

## DEFOGGER SWITCH

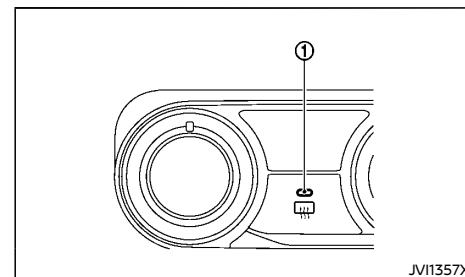

Type A

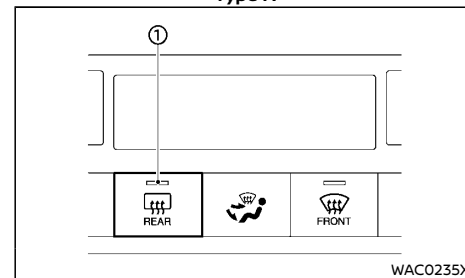

Type B

The rear window defogger switch operates when the ignition switch is in the "ON" position.

The defogger is used to reduce the moisture, fog or frost on the rear window surface to improve the rear view.

When the defogger switch is pushed, the indicator light ① illuminates and the defogger operates for approximately 15 minutes. After the preset time has passed, the defogger will turn off automatically.

To turn off the defogger manually, push the defogger switch again.

## HORN



### CAUTION:

- When operating the defogger continuously, be sure to start the engine. Otherwise, it may cause the battery to discharge.
- When cleaning the inner side of the window, be careful not to scratch or damage the electrical conductors on the surface of the window.

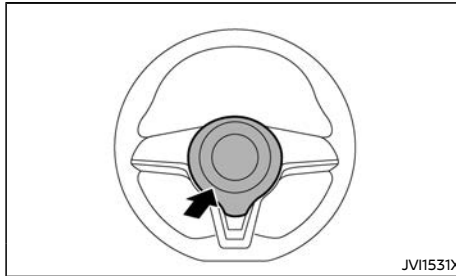

The horn switch operates regardless of the ignition switch position except when the battery is discharged.

When the horn switch is pushed and held, the horn will sound. Releasing the horn switch will cease the horn sound.

## WINDOWS

### POWER WINDOWS



### WARNING:

- Make sure that all passengers have their hands, etc. inside the vehicle before operating the power windows.
- To help avoid risk of injury or death through unintended operation of the vehicle and or its systems, including entrapment in windows or inadvertent door lock activation, do not leave children, people who require the assistance of others or pets unattended in your vehicle. Additionally, the temperature inside a closed vehicle on a warm day can quickly become high enough to cause a significant risk of injury or death to people and pets.

The power windows operate when the ignition switch is in the "ON" position.

To open a window, push down the power window switch.

To close a window, pull up the power window switch.

### Driver's window switch

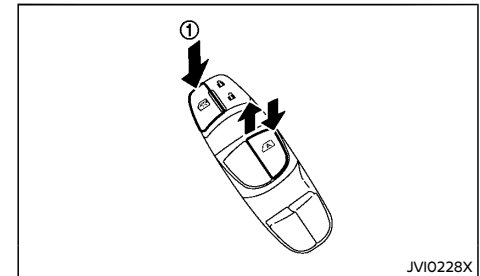

The driver's switch, which is the main switch, can control all windows.

#### Locking passengers' windows:

When the lock button ① is pushed in, the passengers' windows cannot be operated.

To cancel the passengers' windows lock, push the lock button ① again.

#### Passenger's window switch

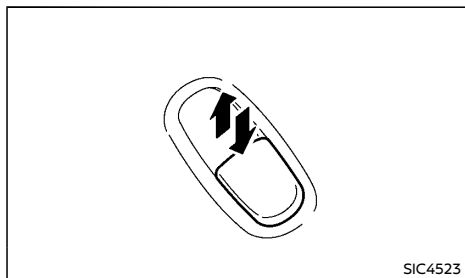

The passenger's switch can control its corresponding window.

When the lock button on the driver's switch is pushed in, the passenger's switch cannot be operated.

#### Automatic function

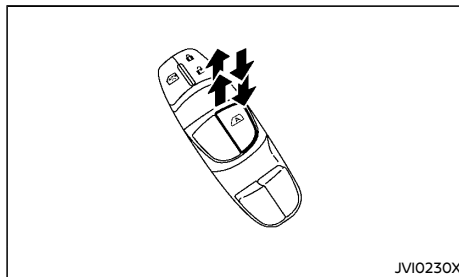

Automatic function is available for the switch that has an **A** mark on its surface.

The automatic function enables a window to fully open or close without holding the switch down or up.

To fully open the window, push the power window switch down to the second detent and release the switch. To fully close the window, pull the power window switch up to the second detent and release the switch. The switch does not have to be held during window operation.

To stop the window open/close operation during the automatic function, push down or pull up the switch in opposite directions.

#### Window timer:

The window timer allows the windows to be operated for a period of time even if the ignition switch is placed in the "OFF" or "LOCK" position. The window timer will be cancelled when the front door is opened or the preset time has been exceeded.

#### Auto-reverse function:



#### WARNING:

**There is a small distance just before the closed position which cannot be detected. Make sure that all passengers have their hands, etc. inside the vehicle before closing the windows.**

The auto-reverse function enables a window to automatically reverse when something is caught in the window as it is closing by the automatic function. When the control unit detects an obstacle, the window will be lowered immediately.

Depending on the environment or driving conditions, the auto-reverse function may activate if an impact or load similar to something being caught in the window occurs.

#### When power window switch does not operate

Some power window functions (automatic close function, auto-reverse function) will not operate as described after the battery cable is disconnected and the electrical supply is interrupted. Perform the following procedure to initialize the power window functions.

1. Start the engine.
2. Close the door.
3. After starting the engine, open the window completely by operating the driver's window switch.
4. Pull up and hold the driver's window switch to close the driver's window. Hold the switch for approximately 3 seconds after the window has been fully closed, and then release it.



## POWER OUTLET

5. Check if the power window functions operate properly.

If you open or close the power window continuously, it may cause the power window not to operate properly. Perform the above procedure.

If the power window functions do not operate properly after performing the above procedure, repeat the steps. See a NISSAN dealer, if necessary, for checking the power window system.

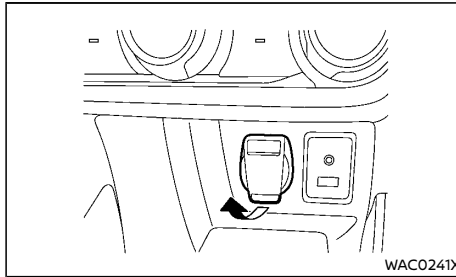

Instrument panel, Right-Hand Drive (RHD) model

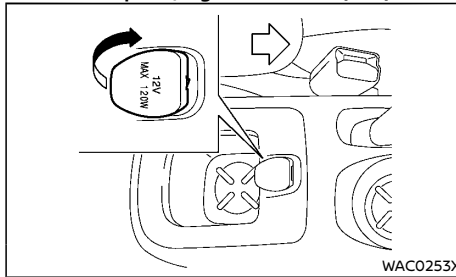

Center console (if equipped)

The power outlet is for powering electrical accessories such as cellular telephone.



### CAUTION:

- The outlet and plug may be hot during or immediately after use.
- This power outlet is not designed for use with a cigarette lighter unit.
- Do not use with accessories that exceed a 12 volt, 120W (10A) power draw. Do not use double adapters or more than one electrical accessory.

- Use power outlet with the engine running to avoid discharging the vehicle battery.
- Avoid using power outlet when the air conditioner, headlights or rear window defogger is on.
- Before inserting or disconnecting a plug, be sure to turn off the power switch of electrical accessory being used and the ignition switch.
- Push the plug in as far as it will go. If good contact is not made, the plug may over-heat or the internal temperature fuse may open.
- Do not allow water to contact the outlet.
- When not in use, be sure to close the cap.

## USB (Universal Serial Bus) CHARGING CONNECTOR (if equipped)

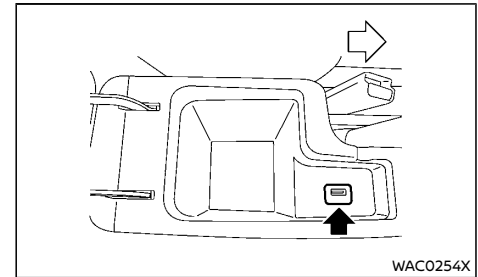

In the console box (if equipped)

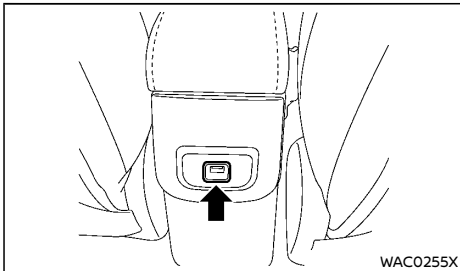

Behind the console box (if equipped)

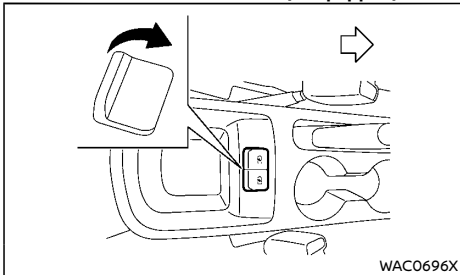

Center console (if equipped)

The USB charging connector can be used only for charging an external device.

Connect a USB device into the connector. Charging will start automatically (maximum output up to 5 volt, 12 W, 2.4 A).

The external device will be charged continuously while the ignition switch is in the "ACC" or "ON" position.

Some mobile devices cannot be charged depending on their specifications.

**⚠ CAUTION:**

- Do not force a USB device into the connector. Inserting the USB device tilted or upside-down into the connector may damage the connector. Make sure that the USB device is connected correctly into the connector.
- Do not use a reversible USB cable. Using the reversible USB cable may damage the connector.

**STORAGE**

**⚠ WARNING:**

- The storages should not be used while driving so full attention may be given to vehicle operation.
- Keep the storage lids closed while driving to help prevent injury in an accident or a sudden stop.

**GLOVE BOX**

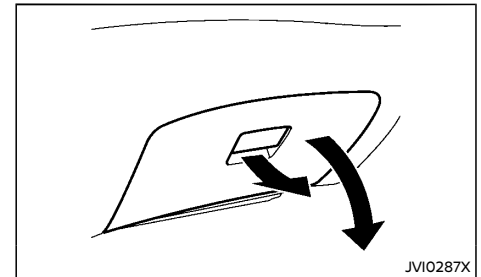

To open the glove box, pull the handle.  
To close, push the lid in until the lock latches.

**CONSOLE BOX (if equipped)**

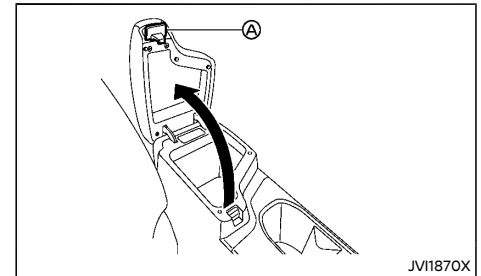

To open the console box, push up the knob **A** and pull up the lid. To close, push the lid down until it is latched.

### CARD HOLDER

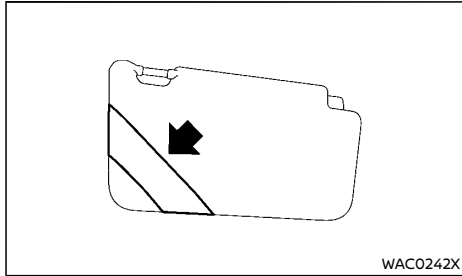

#### Example

Slide a card in the card holder.

### CUP HOLDERS



#### WARNING:

The driver must not remove or insert cups into the cup holder while driving so that full attention may be given to vehicle operation.



#### CAUTION:

Avoid abrupt starting and braking especially when the cup holder is being used to prevent spilling the contents. If the contents are hot, they could scald you or your passengers.

### Front

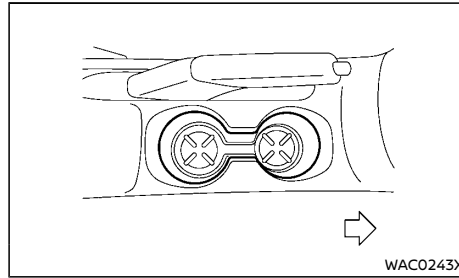

### Rear (if equipped)

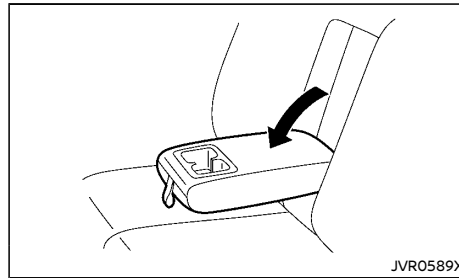

### SOFT BOTTLE HOLDER

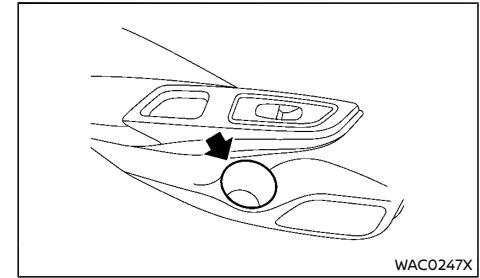

The front and rear seat soft bottle holders are located on the doors.



#### CAUTION:

- Do not use bottle holder for any other objects that could be thrown about in the vehicle and possibly injure people during sudden braking or an accident.
- Do not use bottle holder for open liquid containers.

## SUN VISORS

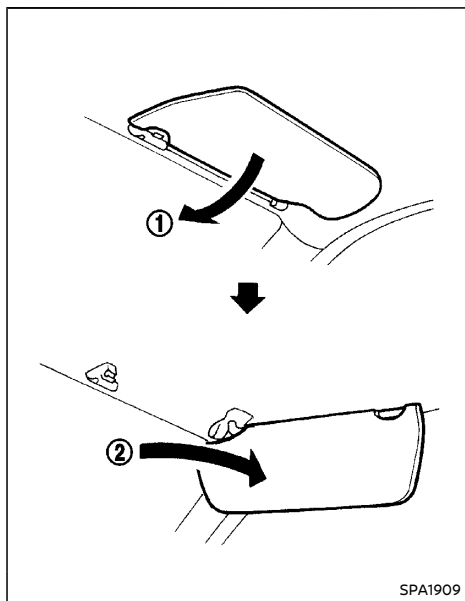

1. To block out glare from the front, swing down the sun visor ①.
2. To block glare from the side, remove the sun visor from the center mount and swing it to the side ②.

## INTERIOR LIGHTS



### CAUTION:

- Do not leave the light switch on when the engine is not running for extended periods of time to prevent the battery from being discharged.
- Turn off the lights when you leave the vehicle.

## MAP LIGHTS

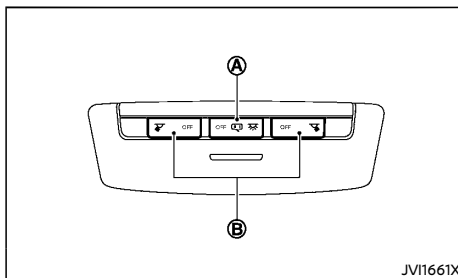

### Switch A

The map light switch A has three positions.

When the switch is in the "ON"  position, the map lights illuminate.

When the switch is in the "DOOR"  position, the map lights illuminate when a door is opened.

The interior light timer (if equipped) will keep the map lights on for approximately 15 seconds when:

- The key is removed from the ignition switch with the driver's door closed. (model without Intelligent Key system)

- The ignition switch is placed in the "OFF" position. (model with Intelligent Key system)
- The doors are unlocked by pushing the "UNLOCK"  button (on the remote controller or Intelligent Key) or the request switch (Intelligent Key system equipped models), with the ignition switch in the "LOCK" position.
- Any door is opened and then closed with the ignition switch in the "LOCK" position and without the key in the ignition switch. (model without Intelligent Key system)
- Any door is opened and then closed with the ignition switch in the "OFF" position. (model with Intelligent Key system)

The interior light will be cancelled when:

- All the doors are locked.
- The ignition switch is placed in the "ON" position.

When the switch is in the "OFF" position, the map lights do not illuminate, regardless of any condition.

### Switch B

The map light switch B has two positions.

When the switch is in the "ON"  position, the map light illuminates.

When the switch is in the "OFF" position, the map light does not illuminate.

## ROOM LIGHT

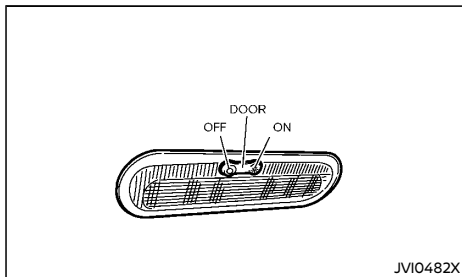

The room light has a three-position switch.

When the switch is in the "ON" position, the room light illuminates.

When the switch is in the "DOOR" position, the room light illuminates when a door is opened.

The interior light timer (if equipped) will keep the room light on for approximately 15 seconds when:

- The key is removed from the ignition switch with the driver's door closed. (model without Intelligent Key system)
- The ignition switch is placed in the "OFF" position. (model with Intelligent Key system)
- The doors are unlocked by pushing the "UNLOCK"  button (on the remote controller or Intelligent Key) or the request switch (Intelligent Key system equipped models), with the ignition switch in the "LOCK" position.
- Any door is opened and then closed with the ignition switch in the "LOCK" position and without the key in the ignition switch. (model without Intelligent Key system)

- Any door is opened and then closed with the ignition switch in the "OFF" position. (model with Intelligent Key system)

The interior light timer will be cancelled when:

- All the doors are locked.
- The ignition switch is placed in the "ON" position.

When the switch is in the "OFF" position, the room light does not illuminate, regardless of any condition.

## TRUNK LIGHT

The trunk light illuminates when the trunk lid is opened. When the trunk lid is closed, the light will turn off.

**MEMO**

# 3 Pre-driving checks and adjustments

Keys .....	3-2	Security system .....	3-15
NISSAN Anti-Theft System (NATS) key (if equipped) .....	3-2	Theft warning system .....	3-15
Intelligent Key (if equipped) .....	3-2	NISSAN Anti-Theft system (NATS) .....	3-15
Doors .....	3-3	Hood .....	3-16
Locking with key .....	3-3	Opening hood .....	3-17
Locking with inside lock knob .....	3-4	Closing hood .....	3-17
Locking with power door lock switch .....	3-4	Trunk lid .....	3-17
Child safety rear door lock .....	3-4	Opening trunk lid .....	3-18
Remote keyless entry system (if equipped) .....	3-5	Trunk button on remote controller (if equipped) .....	3-18
Using remote keyless entry system .....	3-5	Trunk button on Intelligent Key (if equipped) .....	3-18
Intelligent Key system (if equipped) .....	3-6	Trunk open request switch (if equipped) .....	3-18
Operating range .....	3-8	Fuel-filler lid .....	3-18
Using Intelligent Key system .....	3-8	Opening fuel-filler lid .....	3-18
Battery saver system .....	3-10	Fuel-filler cap .....	3-19
Warning and audible reminders .....	3-10	Steering wheel .....	3-19
Troubleshooting guide .....	3-11	Mirrors .....	3-19
Using remote keyless entry system .....	3-13	Inside rearview mirror .....	3-19
Hazard indicator and outside chime operation .....	3-13	Outside rearview mirrors .....	3-20
		Vanity mirror .....	3-21
		Parking brake .....	3-21

## KEYS

Your vehicle can only be driven with the keys specific to your vehicle. A key number plate is supplied with your key. Record the key number and keep the key number plate in a safe place, except in the vehicle, in case of the need to duplicate the keys.

The key can only be duplicated using an original key or the original key number. The key number is required when you have lost all of the keys and do not have the original key to duplicate from. If the key is lost, or you need extra keys, provide an original key or the key number to a NISSAN dealer.

### CAUTION:

**Do not leave the keys inside the vehicle when leaving the vehicle.**

### NISSAN ANTI-THEFT SYSTEM (NATS\*) KEY (if equipped)

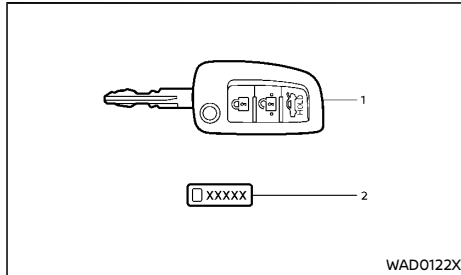

- 1 NATS key (2)
- 2 Key number plate

Your vehicle can only be driven with the NATS keys, which are registered to your vehicle's NATS components. As many as 5 NATS keys can be registered and used with one vehicle.

## 3-2 Pre-driving checks and adjustments

The new keys must be registered by a NISSAN dealer prior to use with the NATS of your vehicle. Since the registration process requires erasing all memory in the NATS components when registering new keys, be sure to take all NATS keys that you have to the NISSAN dealer.

### CAUTION:

**Do not allow the NATS key, which contains an electrical transponder, to come into contact with water or salt water. This could affect the system function.**

\*: Immobilizer

### Mechanical key

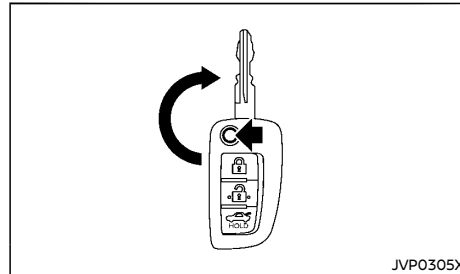

To unfold the key from the fob, push the release button.

When storing the key, push the release button and push key to fold the key back into fob slot.

### INTELLIGENT KEY (if equipped)

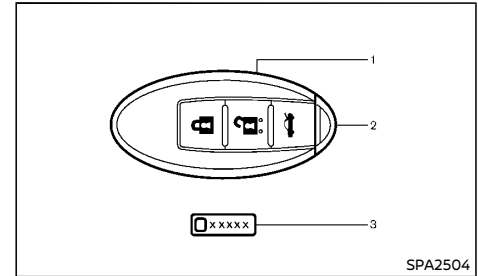

- 1 Intelligent Key (2 sets)
- 2 Mechanical key (inside the Intelligent Key) (2 sets)
- 3 Key number plate

Your vehicle can only be driven with the Intelligent Keys, which are registered to your vehicle's Intelligent Key system components and NISSAN Anti-Theft System (NATS\*) components. As many as 4 Intelligent Keys can be registered and used with one vehicle. The new keys must be registered by a NISSAN dealer prior to use with the Intelligent Key system and NATS of your vehicle. Since the registration process requires erasing all memory in the Intelligent Key components when registering new keys, be sure to take all Intelligent Keys that you have to the NISSAN dealer.

\*: Immobilizer

### CAUTION:

- **Be sure to carry the Intelligent Key with you. Do not leave the vehicle with the Intelligent Key inside.**



- Be sure to carry the Intelligent Key with you when driving. The Intelligent Key is a precision device with a built-in transmitter. To avoid damaging it, please note the following.
  - The Intelligent Key is water resistant; however, wetting may damage the Intelligent Key. If the Intelligent Key gets wet, immediately wipe until it is completely dry.
  - Do not bend, drop or strike it against another object.
  - If the outside temperature is below  $-10^{\circ}\text{C}$  ( $14^{\circ}\text{F}$ ), the battery of the Intelligent Key may not function properly.
  - Do not place the Intelligent Key for an extended period in a place where temperatures exceed  $60^{\circ}\text{C}$  ( $140^{\circ}\text{F}$ ).
  - Do not change or modify the Intelligent Key.
  - Do not use a magnet key holder.
  - Do not place the Intelligent Key near equipment that produces a magnetic field such as a TV, audio equipment and personal computers or cellular phones.
  - Do not allow the Intelligent Key to come into contact with water or salt water, and do not wash it in a washing machine. This could affect the system function.
- If an Intelligent Key is lost or stolen, NISSAN recommends erasing the ID code of that Intelligent Key. This will prevent the Intelligent Key from unauthorized use to unlock the vehicle. For information regarding the erasing procedure, please

contact a NISSAN dealer.

#### Mechanical key

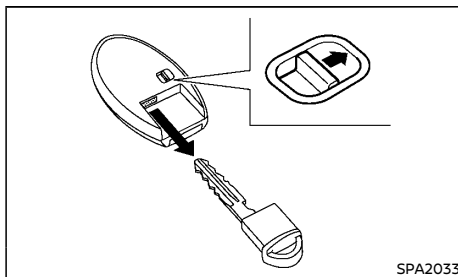

To remove the mechanical key, release the lock knob at the back of the Intelligent Key.

To install the mechanical key, firmly insert it into the Intelligent Key until the lock knob returns to the lock position.

Use the mechanical key to lock or unlock the doors. See "Doors" (P.3-3).

## DOORS



#### WARNING:

- Always look before opening any doors, to avoid an accident with oncoming traffic.
- To help avoid risk of injury or death through unintended operation of the vehicle and or its systems, including entrapment in windows or inadvertent door lock activation, do not leave children, people who require the assistance of others or pets unattended in your vehicle. Additionally, the temperature inside a closed vehicle on a warm day can quickly become high enough to cause a significant risk of injury or death to people and pets.

#### LOCKING WITH KEY

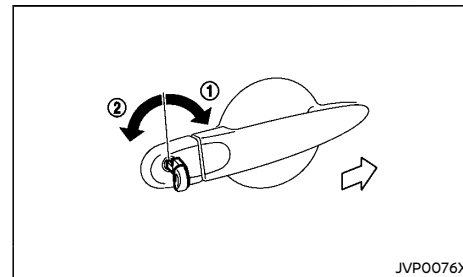

To lock the driver's door, insert the key to the door cylinder located on the driver's side door and turn the key to the front of the vehicle ①.

For locking other doors, use the power door lock switch, the remote controller (if equipped) or the Intelligent Key (if equipped).

To unlock the driver's door, turn the key to the rear of the vehicle ②.

For unlocking other doors, use the power door lock switch, the remote controller or the Intelligent Key.

#### LOCKING WITH INSIDE LOCK KNOB

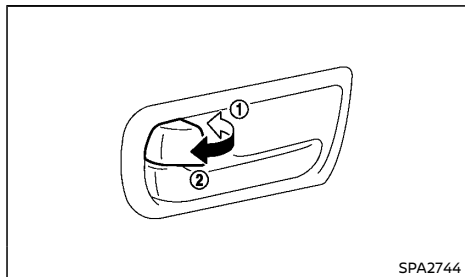

#### CAUTION:

**When locking the doors using the inside lock knob, be sure not to leave the key in the vehicle.**

To lock the front doors, push the inside lock knob to the lock position ①, and then close the door while pulling the door handle.

To lock the rear doors, push the inside lock knob to the lock position ① and then close the door.

To unlock, pull the inside lock knob to the unlock position ②.

When the driver's door is locked, you do not need to operate the inside lock knob. Just pull the inside door handle to open the driver's door.

#### LOCKING WITH POWER DOOR LOCK SWITCH

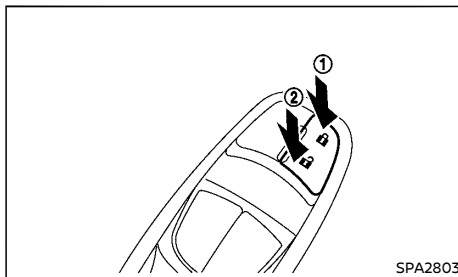

#### CAUTION:

- **When locking the doors using the power door lock switch, be sure not to leave the key in the vehicle.**
- **When the Intelligent Key (if equipped) is left in the vehicle, and you try to lock the door using the power door lock switch after getting out of the vehicle, all the doors will unlock automatically after the door is closed.**

To lock the doors, push the power door lock switch to the lock position ①.

To unlock, push the power door lock switch to the unlock position ②.

#### CHILD SAFETY REAR DOOR LOCK

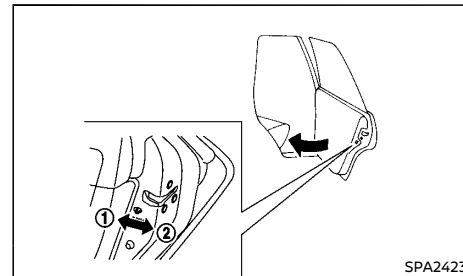

The child safety rear door locks help prevent rear doors from being opened accidentally, especially when small children are in the vehicle.

When the levers are in the lock position ①, the child safety rear door locks engage and the rear doors can only be opened by the outside door handles.

To disengage, move the levers to the unlock position ②.

## REMOTE KEYLESS ENTRY SYSTEM (if equipped)

The remote keyless entry system can operate all door locks using the remote controller. The remote controller can operate at a distance of approximately 1 m (3.3 ft) away from the vehicle. The operating distance depends upon the conditions around the vehicle.

As many as 5 remote controllers can be used with one vehicle. For information about the purchase and use of additional remote controllers, contact a NISSAN dealer.

The remote controller will not function under the following conditions:

- When the distance between the remote controller and vehicle is more than approximately 1 m (3.3 ft).
- When the remote controller battery is discharged.
- When the key is in the ignition switch.

### CAUTION:

- **When locking the doors using the remote controller, be sure not to leave the key in the vehicle.**
- **Do not allow the remote controller, which contains electrical components, to come into contact with water or salt water. This could affect the system function.**
- **Do not drop the remote controller.**
- **Do not strike the remote controller sharply against another object.**
- **If the outside temperature is below  $-10^{\circ}\text{C}$  ( $14^{\circ}\text{F}$ ), the battery of the remote controller may not function properly.**
- **Do not place the remote controller for an extended period in an area where temperatures exceed  $60^{\circ}\text{C}$  ( $140^{\circ}\text{F}$ ).**



If a remote controller is lost or stolen, NISSAN

recommends erasing the ID code of that remote controller from the vehicle. This may prevent the unauthorized use of the remote controller to unlock the vehicle. For information regarding the erasing procedure, contact a NISSAN dealer.

For information regarding the replacement of a battery, see "Remote controller battery" (P.8-15).

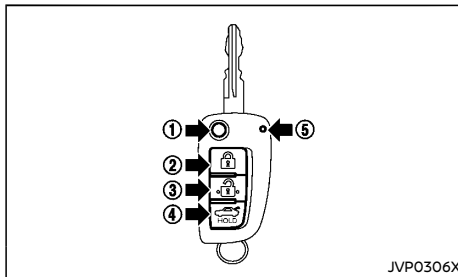
## USING REMOTE KEYLESS ENTRY SYSTEM



- ① Jackknife type key release button
- ② LOCK button 
- ③ UNLOCK button 
- ④ TRUNK button  HOLD
- ⑤ Battery indicator light

### Locking doors

1. Remove the key from the ignition switch.
2. Close all doors.
3. Push the "LOCK"  button ② on the remote controller.
4. All doors will be locked.

5. Operate door handles to confirm that the doors have been securely locked.

### CAUTION:

**After locking the doors using the remote controller, be sure that the doors have been securely locked by operating the door handles.**

### Unlocking doors

1. Push the "UNLOCK"  button ③ on the remote controller.
2. All doors will be unlocked.

All doors will be locked automatically unless one of the following operations is performed within 30 seconds after pushing the "UNLOCK"  button ③.

- Opening any doors.
- Inserting the key into the ignition switch.

### Opening trunk lid

1. Push and hold the "TRUNK"  button ④ on the remote controller for longer than 1 second with the key removed from the ignition switch.
2. The trunk lid opens.

### Battery indicator light

The battery indicator light ⑤ illuminates when you push any button. If the light does not illuminate, the battery is weak or needs replacement. For information regarding replacement of a battery, see "Remote controller battery" (P.8-15).

## INTELLIGENT KEY SYSTEM (if equipped)

### Hazard indicator operation

When you lock or unlock the doors, the hazard indicator will flash as a confirmation.

- "LOCK": The hazard indicator flashes twice.
- "UNLOCK": The hazard indicator flashes once.

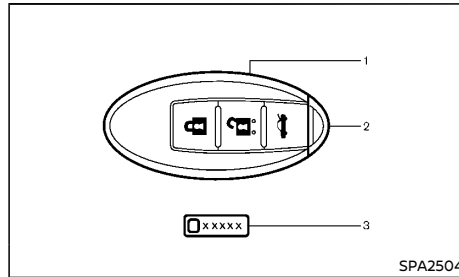

1. Intelligent Key (2)
2. Mechanical key (inside the Intelligent Key) (2)
3. Key number plate



### WARNING:

- **Radio waves could adversely affect electric medical equipment. Those who use a pacemaker should contact the electric medical equipment manufacturer for the possible influences before use.**
- **The Intelligent Key transmits radio waves when the buttons are pushed. The radio waves may affect aircraft navigation and communication systems. Do not operate the Intelligent Key while on an airplane. Make sure the buttons are not operated unintentionally when the unit is stored during a flight.**

The Intelligent Key system can be used to operate all the doors and the trunk locks using the remote controller function or pushing the request switch on the vehicle without taking the key out from a pocket or purse. The operating environment and/or conditions may affect the Intelligent Key system opera-

tion.

Be sure to read the following before using the Intelligent Key system.



### CAUTION:

- **Be sure to carry the Intelligent Key with you when operating the vehicle.**
- **Never leave the Intelligent Key in the vehicle when you leave the vehicle.**
- **When the outside temperature is extremely low, the Intelligent Key system may not function properly.**

The Intelligent Key is always communicating with the vehicle as it receives radio waves. The Intelligent Key system transmits weak radio waves. Environmental conditions may interfere with the operation of the Intelligent Key system under the following operating conditions.

- When operating near a location where strong radio waves are transmitted, such as a TV tower, power station and broadcasting station.
- When in possession of wireless equipment, such as a cellular telephone, transceiver, and CB radio.
- When the Intelligent Key is in contact with or covered by metallic materials.
- When any type of radio wave remote control is used nearby.
- When the Intelligent Key is placed near an electric appliance such as a personal computer.
- When the vehicle is parked near a parking meter.

In such cases, correct the operating conditions before using the Intelligent Key function or use the mechanical key.

Although the life of the battery varies depending on the operating conditions, the battery's life is approximately 2 years. If the battery is discharged, replace it with a new one.

For information regarding replacement of a battery, see "Intelligent Key battery" (P.8-16).

Since the Intelligent Key is continuously receiving radio waves, if the key is left near equipment which transmits strong radio waves, such as signals from a TV and personal computer, the battery life may become shorter.

When the battery is almost discharged, see "Intelligent Key battery discharge" (P.5-9) to start the engine.

Because the steering wheel is locked electrically, unlocking the steering wheel with the ignition switch in the "LOCK" position is impossible when the vehicle battery is completely discharged. Pay special attention that the vehicle battery is not completely discharged.

As many as 4 Intelligent Keys can be used with one vehicle. For information about the purchase and use of additional Intelligent Keys, contact a NISSAN dealer.



**CAUTION:**

- **Do not allow the Intelligent Key, which contains electrical components, to come into contact with water or salt water. This could affect the system function.**
- **Do not drop the Intelligent Key.**
- **Do not strike the Intelligent Key sharply against another object.**
- **Do not change or modify the Intelligent Key.**
- **Wetting may damage the Intelligent Key. If the Intelligent Key gets wet, immediately wipe until it is completely dry.**

- **If the outside temperature is below  $-10^{\circ}\text{C}$  ( $14^{\circ}\text{F}$ ), the battery of the Intelligent Key may not function properly.**
- **Do not place the Intelligent Key for an extended period in an area where temperatures exceed  $60^{\circ}\text{C}$  ( $140^{\circ}\text{F}$ ).**
- **Do not attach the Intelligent Key with a key holder that contains a magnet.**
- **Do not place the Intelligent Key near equipment that produces a magnetic field, such as a TV, audio equipment and personal computers or cellular phones.**

If an Intelligent Key is lost or stolen, NISSAN recommends erasing the ID code of that Intelligent Key from the vehicle. This may prevent the unauthorized use of the Intelligent Key to operate the vehicle. For information regarding the erasing procedure, contact a NISSAN dealer.

The Intelligent Key function can be disabled. For information about disabling the Intelligent Key function, contact a NISSAN dealer.

## OPERATING RANGE

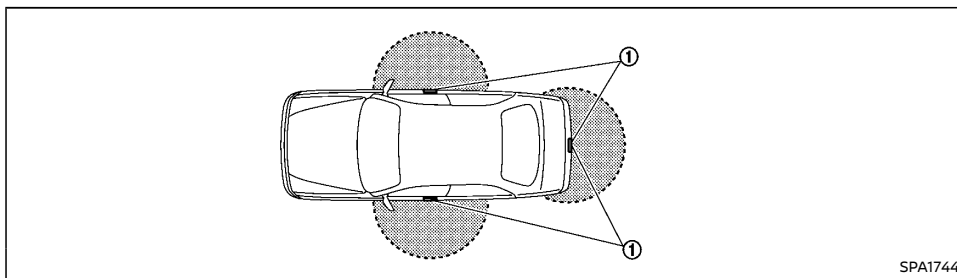

The Intelligent Key functions can only be used when the Intelligent Key is within the specified operating range from the request switch ①.

When the Intelligent Key battery is discharged or strong radio waves are present near the operating location, the Intelligent Key system's operating range becomes narrower, and the Intelligent Key may not function properly.

The operating range is within 80 cm (31.50 in) from each request switch ①.

If the Intelligent Key is too close to the door glass, handle or rear bumper the request switches may not function.

When the Intelligent Key is within the operating range, it is possible for anyone, even someone who does not carry the Intelligent Key, to push the request switch and lock/unlock the doors and the trunk.

## USING INTELLIGENT KEY SYSTEM

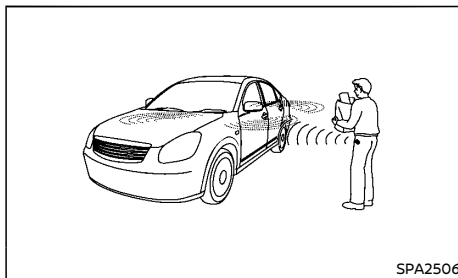

The request switch will not function under the following conditions:

- When the Intelligent Key is left inside the vehicle
- When the Intelligent Key is not within the operational range
- When any door is open or not closed securely
- When the Intelligent Key battery is discharged

- When the ignition switch is in the "ON" position

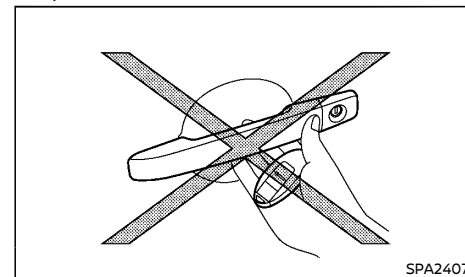

- Do not push the door handle request switch with the Intelligent Key held in your hand as illustrated. The close distance to the door handle will cause the Intelligent Key system to have difficulty recognizing that the Intelligent Key is outside the vehicle.
- After locking the doors using the door handle request switch, make sure that the doors have been securely locked by operating the door handles.
- When locking the doors using the door handle request switch, make sure to have the Intelligent Key in your possession before operating the door handle request switch to prevent the Intelligent Key from being left in the vehicle.
- The door handle request switch is operational only when the Intelligent Key has been detected by the Intelligent Key system.
- To prevent the Intelligent Key from being left inside the vehicle or the trunk, make sure you are carrying the key with you and then lock the doors or the trunk.

- Do not pull the door handle before pushing the door handle request switch. The door will be unlocked but will not open. Release the door handle once and pull it again to open the door.

### Welcome light and farewell light function (if equipped)

When you lock or unlock the doors, the clearance lights, tail lights and the license plate lights will illuminate for a period of time. The welcome light and farewell light function can be disabled. For information about disabling the welcome light and farewell light function, see "Settings" (P.2-20).

### Locking doors

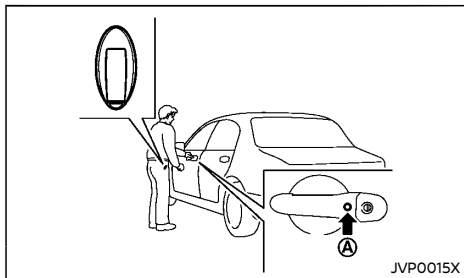

When you carry the Intelligent Key with you, you can lock or unlock all doors by pushing the door handle request switch (driver's or front passenger's) Ⓐ within the range of operation.

When you lock or unlock the doors, the hazard indicator will flash and the outside chime will sound as a confirmation. For details, see "Hazard indicator and outside chime operation" (P.3-13).

1. Push the ignition switch to the "OFF" position.
2. Carry the Intelligent Key with you.
3. Close all doors and the trunk.
4. Push the door handle request switch Ⓐ (driver's or front passenger's).
5. All doors and the trunk will be locked.
6. Operate door handles to confirm that the doors have been securely locked.

### Lockout protection:

To prevent the Intelligent Key from being accidentally locked in the vehicle, lockout protection is equipped with the Intelligent Key system.

- When the Intelligent Key is left in the vehicle and you try to lock the door using the driver's inside lock knob after getting out of the vehicle, all the doors will unlock automatically after the driver's inside lock knob is operated.
- When the Intelligent Key is left in the vehicle while the driver's door is opened and you try to lock the door using the power door lock switch after getting out of the vehicle, all the doors will unlock automatically after the power door lock switch is operated.



### CAUTION:

The lockout protection may not function under the following conditions:

- When the Intelligent Key is placed on top of the instrument panel.
- When the Intelligent Key is placed on the top of the rear parcel.
- When the Intelligent Key is placed inside of the glove box.

- When the Intelligent Key is placed inside of the door pockets.
- When the Intelligent Key is placed on or under the spare tire area.
- When the Intelligent Key is placed on the outer side of the trunk area.
- When the Intelligent Key is placed inside or near metallic materials.

The lockout protection may function when the Intelligent Key is outside the vehicle but is too close to the vehicle.

### Unlocking doors

1. Carry the Intelligent Key with you.
2. Push the door handle request switch Ⓐ.
3. All doors and the trunk will be unlocked.

If a door handle is pulled while unlocking the doors, that door may not be unlocked. Returning the door handle to its original position will unlock the door. If the door does not unlock, after returning the door handle, push the door handle request switch to unlock the door.

### Automatic reload:

All doors will be locked automatically unless one of the following operations is performed within 30 seconds after pushing the request switch while the doors are locked.

- Opening any doors.
- Pushing the ignition switch.

If during the preset time period the "UNLOCK" button on the Intelligent Key is pushed, all doors will be locked automatically after the next preset time.

## Opening trunk lid

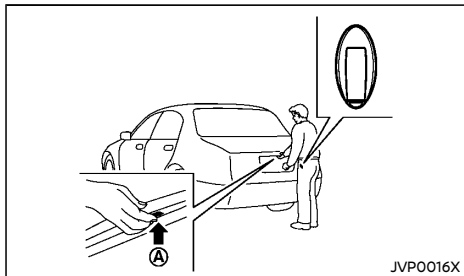

1. Carry the Intelligent Key.
2. Push the trunk open request switch **A**.
3. The trunk will be unlatched.
4. The outside chime sounds 4 times.
5. Raise the trunk lid to open the trunk.



### CAUTION:

**When closing the trunk, make sure to have the Intelligent Key in your possession before closing the trunk to prevent the Intelligent Key from being left in the trunk.**

### Lockout protection:

To prevent the Intelligent Key from being accidentally locked in the trunk, the Intelligent Key system is equipped with lockout protection.

When the trunk lid is closed with all the doors locked and the Intelligent Key inside the trunk, a chime will sound and the trunk lid will open.



### CAUTION:

**The lockout protection may not function under the following conditions.**

- **When the Intelligent Key is placed on or under the spare tire area.**
- **When the Intelligent Key is placed at the outer side of the trunk area.**
- **When the Intelligent Key is placed inside or near metallic materials.**

## BATTERY SAVER SYSTEM

When all the following conditions are met for a period of time, the battery saver system will cut off the power supply to prevent battery discharge.

- All doors are closed, and
- The engine is stopped.

## WARNING AND AUDIBLE REMINDERS

The Intelligent Key system is equipped with a function that is designed to minimize improper operations of the Intelligent Key and to help prevent the vehicle from being stolen.

### Type A

A chime or beep sounds inside and outside the vehicle and a warning light in the meter illuminates or blinks.

See "Troubleshooting guide" (P.3-11) and "Warning lights, indicator lights and audible reminders" (P.2-12).

Intelligent Key system warning light: 

P position selecting warning light: 



### CAUTION:

**When the chime or beep sounds or the warning light illuminates or blinks, be sure to check both the vehicle and the Intelligent Key.**

### Type B

The warning buzzer sounds and the warning display appears on the vehicle information display when improper operations are detected.

See "Troubleshooting guide" (P.3-11). For warning and indicators on the vehicle information display, see "Vehicle information display warnings and indicators" (P.2-24).



### CAUTION:

**When the buzzer sounds and the warning display appears, be sure to check both the vehicle and the Intelligent Key.**







## TROUBLESHOOTING GUIDE

	Symptom	Possible cause	Action to take
When pushing the ignition switch to stop the engine	Type A: The P position selecting warning light in the meter illuminates and the inside warning chime sounds continuously or for a few seconds. (Continuously Variable Transmission model)	The shift lever is not in the "P" (Park) position.	Shift the shift lever to the "P" (Park) position.
	Type B: The Shift to Park warning appears on the vehicle information display and the inside warning chime sounds continuously or for a few seconds. (Continuously Variable Transmission model)		
When shifting the shift lever to the "P" (Park) position (Continuously Variable Transmission model)	The inside warning chime sounds for a few seconds.	The door is open position.	Push the ignition switch to the "OFF" position.
When closing the door after getting out of the vehicle	Type A: The Intelligent Key system warning light in the meter blinks in yellow, the outside chime sounds 3 times and the inside warning chime sounds for a few seconds.	The ignition switch is in the "ON" position.	Push the ignition switch to the "OFF" position.
	Type B: The No Key Detected warning appears in the vehicle information display, the outside chime sounds three times and the inside warning chime sounds for a few seconds.		
	Type A: The P position selecting warning light in the meter illuminates and the outside chime sounds continuously. (Continuously Variable Transmission model)	The ignition switch is in the "OFF" position and the shift lever is not in the "P" (Park) position.	Move the shift lever to the "P" (Park) position and push the ignition switch to the "OFF" position.
	Type B: The Shift to Park warning appears on the vehicle information display and the outside chime sounds continuously. (Continuously Variable Transmission model)		
When pushing the request switch to lock the door	The outside chime sounds for a few seconds and all the doors unlock.	The Intelligent Key is inside the vehicle or the trunk.	Carry the Intelligent Key with you.
When pushing the door handle request switch to lock the door	The outside chime sounds for a few seconds.	The Intelligent Key is inside the vehicle or the trunk.	Carry the Intelligent Key with you.

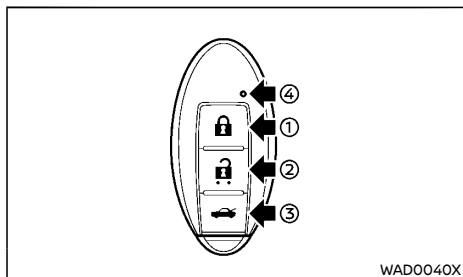
	Symptom	Possible cause	Action to take
When pushing the ignition switch to start the engine	Type A: The Intelligent Key system warning light in the meter blinks in green.	The battery charge is low.	Replace the battery with a new one. (See "Intelligent Key battery" (P.8-16).)
	Type B: The Key Battery Low warning appears in the vehicle information display.		
	Type A: The Intelligent Key system warning light in the meter blinks in yellow and the inside warning chime sounds for a few seconds.	The Intelligent Key is not in the vehicle.	Carry the Intelligent Key with you.
	Type B: The No Key Detected warning appears in the vehicle information display.		
When pushing the ignition switch	Type A: The Intelligent Key system warning light in the meter illuminates in yellow.	It warns of a malfunction with the electrical steering lock system or the Intelligent Key system.	Contact a NISSAN dealer.
	Type B: The Key System Error warning appears in the vehicle information display.		

## USING REMOTE KEYLESS ENTRY SYSTEM



- ① LOCK button 
- ② UNLOCK button 
- ③ TRUNK button 
- ④ Battery indicator light

### Operating range

The remote keyless entry system allows you to lock/unlock all doors and to unlock the trunk. The operating distance depends upon the conditions around the vehicle. To securely operate the lock and unlock buttons, approach the vehicle to about 1 m (3.3 ft) from the door.

The remote keyless entry system will not function under the following conditions:

- When the Intelligent Key is not within the operational range.
- When the Intelligent Key battery is discharged.
- When the doors or the trunk are open or not closed securely.

For information regarding the replacement of a battery, see "Intelligent Key battery" (P.8-16).

### Locking doors

When you lock or unlock the doors, the hazard indicator will flash and the outside chime will sound as a confirmation.

1. Place the ignition switch in the "OFF" position and carry the Intelligent Key.
2. Close all doors.
3. Push the "LOCK"  button ① on the Intelligent Key.
4. All doors will be locked.
5. Operate the door handles to confirm that the doors have been securely locked.





#### CAUTION:

**After locking the doors using the Intelligent Key, be sure that the doors have been securely locked by operating the door handles.**

### Unlocking doors

1. Push the "UNLOCK"  button ② on the Intelligent Key.
2. All doors will be unlocked.

#### Automatic relock:

All doors will be locked automatically unless one of the following operations is performed within 30 seconds after pushing the "UNLOCK"  button ② on the Intelligent Key while the doors are locked. If during this 30-second time period, the "UNLOCK"  button ② on the Intelligent Key is pushed, all doors will be locked automatically after another 30 seconds.

- Opening any doors.
- Pushing the ignition switch.

### Battery indicator light

The battery indicator light ④ flashes when you push any button. If the light does not flash, the battery is weak or needs replacement. For information regarding replacement of a battery, see "Intelligent Key battery" (P.8-16).



### Opening trunk lid

1. Push the "TRUNK"  button ③ on the Intelligent Key for more than 1 second.
2. The trunk will be unlatched.
3. The outside chime sounds 4 times.
4. Raise the trunk lid to open the trunk.

### HAZARD INDICATOR AND OUTSIDE CHIME OPERATION

When you lock or unlock the doors or the trunk lid with the request switch or the remote keyless entry function, the hazard indicator will flash and the outside chime will sound as a confirmation.

The following descriptions show how the hazard indicator and outside chime will activate when locking or unlocking the doors or the trunk.

<b>Operation</b>	<b>DOOR LOCK</b>	<b>DOOR UNLOCK</b>	<b>TRUNK UNLOCK</b>
<b>Intelligent Key system (using request switch)</b>	HAZARD - <b>once</b> OUTSIDE CHIME - <b>once</b>	HAZARD - <b>twice</b> OUTSIDE CHIME - <b>twice</b>	HAZARD - none OUTSIDE CHIME - <b>4</b> <b>times</b>
<b>Remote keyless entry system (using  or  button)</b>	HAZARD - <b>once</b> OUTSIDE CHIME - <b>once</b>	HAZARD - <b>twice</b> OUTSIDE CHIME - <b>twice</b>	HAZARD - none OUTSIDE CHIME - <b>4</b> <b>times</b>

## SECURITY SYSTEM

Your vehicle is equipped with the following security systems:

- Theft warning system
- NISSAN Anti-Theft System (NATS)\* (\* immobilizer)

The security condition will be shown by the security indicator light.

### THEFT WARNING SYSTEM

The theft warning system provides visual and audio alarm signals if parts of the vehicle are disturbed.

#### Security indicator light

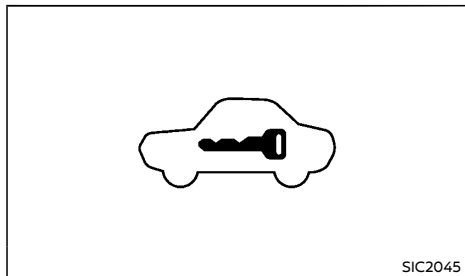

The security indicator light is located in the meter panel.

This light operates whenever the ignition switch is in the "OFF" or "LOCK" position. This is normal.

#### How to activate the system:

1. Close all windows and place the ignition switch in the "OFF" or "LOCK" position.

**The system can be activated even if the windows are open.**

2. Carry the remote controller or the Intelligent Key with you and get out of the vehicle.
3. Make sure the hood and the trunk are closed. Close and lock all doors with the remote controller (if equipped), Intelligent Key (if equipped) or the request switch (Intelligent Key equipped model).
4. Confirm that the security indicator light comes on. The security indicator light stays on for approximately 30 seconds. The vehicle security system is now pre-armed. After approximately 30 seconds the vehicle security system automatically shifts into the armed phase. The security light begins to flash once every approximately 3 seconds.

If, during this 30-second pre-arm time period, the door is unlocked with the remote controller, Intelligent Key, request switch or the ignition switch is placed in the "ON" position, the system will not arm.

**Even when the driver and/or passengers are in the vehicle, the system will activate with all doors locked and ignition switch in the "LOCK" position. Place the ignition switch in the "ON" position to turn the system off.**

#### Theft warning system operation:

The warning system will give the following alarm:

- The headlights blink and the horn sounds intermittently for approximately 30 seconds.
- The alarm automatically turns off after approximately 30 seconds. However, the alarm reactivates if the vehicle is tampered with again.

The alarm is activated by:

- Operating the door or the trunk without using the remote controller, the Intelligent Key or the request switch.
- Opening the hood.

#### How to stop alarm:

- The alarm will stop by unlocking a door with the remote controller, Intelligent Key or the request switch.
- The alarm will stop when the ignition switch is placed in the "ON" position.

**If the system does not operate as described above, have it checked by a NISSAN dealer.**

### NISSAN ANTI-THEFT SYSTEM (NATS)

The NISSAN Anti-Theft System (NATS) will not allow the engine to start without the use of the registered NATS key.

If the engine does not start using the registered NATS key, it may be due to interference caused by:

- Another NATS key.
- Automated toll road device.
- Automated payment device.
- Other devices that transmit similar signals.

Start the engine using the following procedure:

1. Remove any items that may be causing the interference away from the NATS key.
2. Leave the ignition switch in the "ON" position for approximately 5 seconds.
3. Place the ignition switch in the "OFF" or "LOCK" position, and wait approximately 10 seconds.
4. Repeat steps 2 and 3 again.
5. Start the engine.
6. Repeat the steps above until all possible interferences are eliminated.

## HOOD

If this procedure allows the engine to start, NISSAN recommends placing the registered NATS key separate from other devices to avoid interference.

### Security indicator light

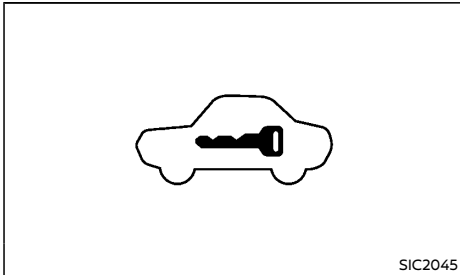

The security indicator light is located on the meter panel. It indicates the status of NATS.

The light operates whenever the ignition switch is in the "LOCK" or "OFF" position. The security indicator light indicates that the security systems on the vehicle are operational.

If NATS is malfunctioning, this light will remain on while the ignition switch is in the "ON" position.

**If the light remains on and/or the engine does not start, contact a NISSAN dealer for NATS service as soon as possible. Be sure to bring all NATS keys that you have when visiting a NISSAN dealer for service.**



### WARNING:

- **The hood must be closed and latched securely before driving. Failure to do so could cause the hood to fly open and result in an accident.**
- **Never open the hood if steam or smoke is coming from the engine compartment to avoid injury.**

## OPENING HOOD

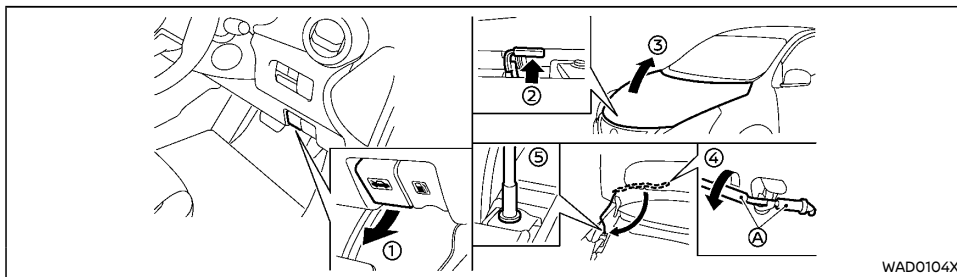

1. Pull the hood lock release handle ① located below the instrument panel until the hood springs up.
2. Locate the lever ② in between the hood and grille and pull the lever up with your fingertips.
3. Raise the hood ③.
4. Remove the support rod ④ and insert it into the slot ⑤.

**Hold the coated part A when removing or resetting the support rod. Avoid direct contact with the metal parts, as they may be hot immediately after the engine has been stopped.**

## CLOSING HOOD

1. While supporting the hood, return the support rod to its original position.
2. Slowly lower the hood to about 20 to 30 cm (8 to 12 in) above the hood lock, then let it drop.
3. Make sure it is securely latched.

## TRUNK LID



### WARNING:

- The trunk lid must be closed securely before driving. An open trunk lid could allow dangerous exhaust gases to be drawn inside the vehicle.
- Closely supervise children when they are around your vehicle to prevent them from playing and becoming locked in the trunk where they could be seriously injured. Keep the vehicle locked, with the trunk lid closed when not in use, and keep access to vehicle keys away from children.

The trunk lid can be opened by performing one of the following operations.

- Using the trunk lid release lever
- Using the TRUNK button on the remote controller (if equipped) or the Intelligent Key (if equipped)
- Using the trunk open request switch (if equipped)

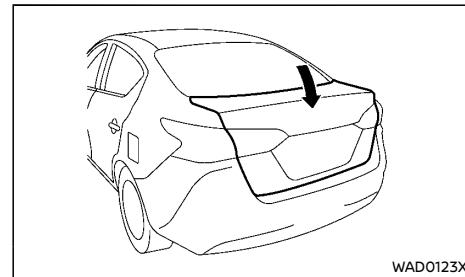

To close the trunk lid, push the trunk lid down until it securely locks.

## OPENING TRUNK LID

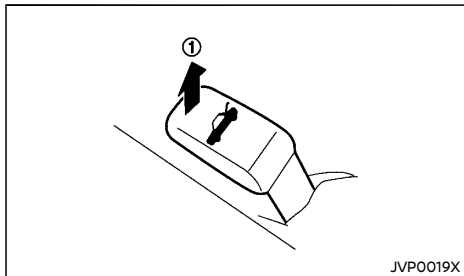

Pull up the trunk lid release lever ① located on the driver's side floor until the trunk lid is unlatched.

## TRUNK BUTTON ON REMOTE CONTROLLER (if equipped)

To open the trunk lid, push the "TRUNK"  button on the remote controller. (See "Remote keyless entry system" (P.3-5).)

## TRUNK BUTTON ON INTELLIGENT KEY (if equipped)

To open the trunk lid, push the "TRUNK"  button on the Intelligent Key. (See "Intelligent Key system" (P.3-6).)

## TRUNK OPEN REQUEST SWITCH (if equipped)

To open the trunk lid, push the trunk open request switch while carrying the Intelligent Key. (See "Intelligent Key system" (P.3-6).)

## FUEL-FILLER LID

### WARNING:

- Gasoline is extremely flammable and highly explosive under certain conditions. You could be burned or seriously injured if it is misused or mishandled. Always stop the engine and do not smoke or allow open flames or sparks near the vehicle when refueling.
- Fuel may be under pressure. Turn the cap a half of a turn, and wait for any "hissing" sound to stop to prevent fuel from spraying out and possibly causing personal injury. Then remove the cap.
- Use only an original equipment type fuel-filler cap as a replacement. It has a built-in safety valve needed for proper operation of the fuel system and emission control system. An incorrect cap can result in a serious malfunction and possible injury.

## OPENING FUEL-FILLER LID

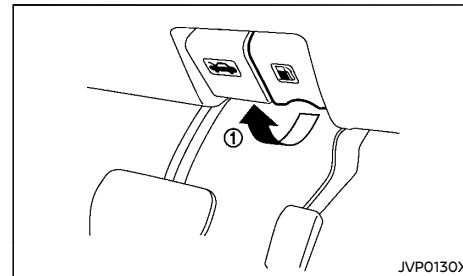

To open the fuel-filler lid, pull the fuel-filler lid release handle ①.



## FUEL-FILLER CAP

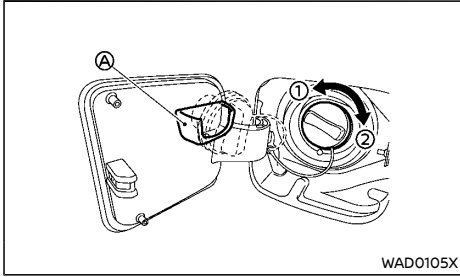

Turn the fuel-filler cap counterclockwise ① to remove. To tighten, turn the fuel-filler cap clockwise ② until a single click is heard.

Put the fuel-filler cap on the cap holder ④ while refueling.



### CAUTION:

If fuel is spilled on the vehicle body, flush it away with water to avoid paint damage.

## STEERING WHEEL



### WARNING:

Never adjust the steering wheel while driving so that full attention may be given to vehicle operation.

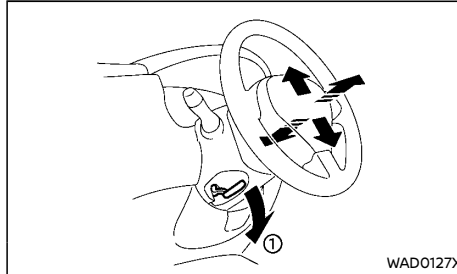

Pull the lock lever ① down and adjust the steering wheel up, down, forward or rearward to the desired position. Push the lock lever up securely to lock the steering wheel in place.

## MIRRORS



### WARNING:

Adjust the position of all mirrors before driving. Do not adjust the mirror positions while driving so that full attention may be given to vehicle operation.

## INSIDE REARVIEW MIRROR

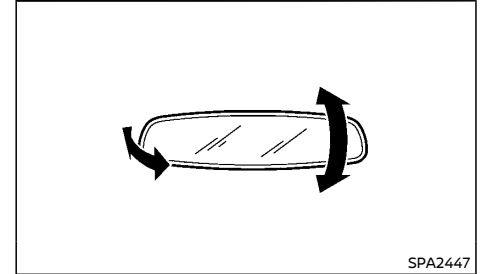

### Example

While holding the inside rearview mirror, adjust the mirror angles until the desired position is achieved.

## Manual anti-glare type

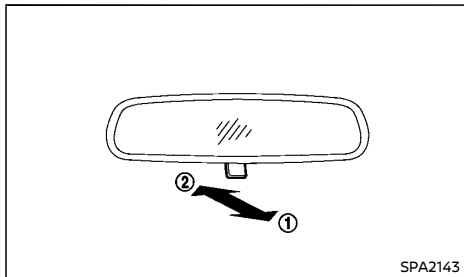

### Example

Pull the adjusting lever ① when the glare from the headlights of the vehicle behind you obstructs your vision at night.

Push the adjusting lever ② during the day for the best rearward visibility.

## OUTSIDE REARVIEW MIRRORS

### WARNING:

- Never touch the outside rearview mirrors while they are in motion. Doing so may pinch your fingers or damage the mirror.
- Never drive the vehicle with the outside rearview mirrors folded. This reduces rear view visibility and may lead to an accident.
- Objects viewed in the outside mirror are closer than they appear. (if equipped)
- The picture dimensions and distance in the outside mirrors are not real.

## Adjusting

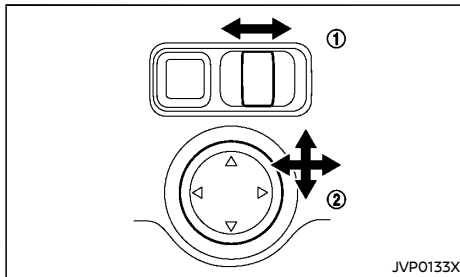

The outside rearview mirror remote control operates when the ignition switch is in the "ACC" or "ON" position.

1. Move the switch ① to select the right or left mirror.
2. Adjust each mirror until the desired position is achieved. ②

## Folding

### Remote control type:

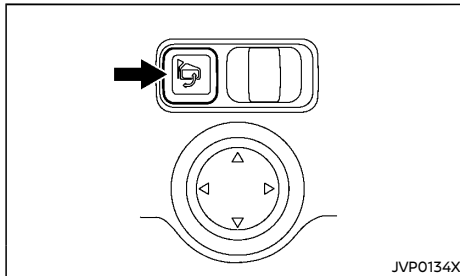

The outside rearview mirror remote control operates when the ignition switch is in the

"ACC" or "ON" position.

The outside rearview mirrors automatically fold when the outside rearview mirror folding switch is pushed. To unfold, push the switch again.

### CAUTION:

- Continuously performing the fold/unfold operation of the outside rearview mirror may cause the switch to stop the operation.
- Do not touch the mirrors while they are moving. Your hand may be pinched, and the mirror may malfunction.
- Do not drive with the mirrors stored. You will be unable to see behind the vehicle.
- If the mirrors were folded or unfolded by hand, there is a chance that the mirror will move forward or backward during driving. If the mirrors were folded or unfolded by hand, be sure to adjust them again electrically before driving.

### Manual type:

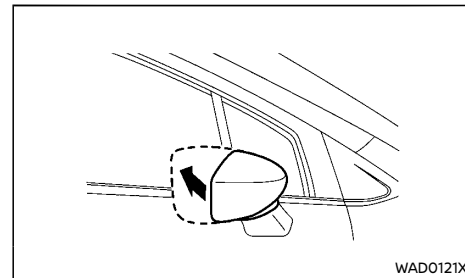

Fold the outside rearview mirror by pushing it toward the rear of the vehicle.

## PARKING BRAKE

### Automatic fold (if equipped):

The outside rearview mirrors automatically fold when the doors are locked with the Intelligent Key or the request switch. The mirrors unfold when the doors are unlocked with the Intelligent Key or the request switch, when the ignition switch is placed in the "ON" position, or when the engine is started. For information about disabling the automatic fold function, see "Vehicle Settings" (P.2-21).

### VANITY MIRROR

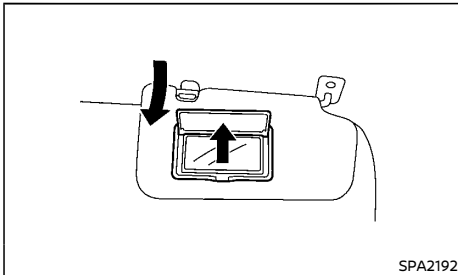

To access the vanity mirror, pull the sun visor down and pull up the mirror cover.



### WARNING:

- **Never drive the vehicle with the parking brake applied. The brake will overheat and fail to operate and will lead to an accident.**
- **Never release the parking brake from outside the vehicle. If the vehicle moves, it will be impossible to push the foot brake pedal and will lead to an accident.**
- **Never use the shift lever in place of the parking brake. When parking, be sure the parking brake is fully applied.**
- **To help avoid risk of injury or death through unintended operation of the vehicle and/or its systems, do not leave children, people who require the assistance of others or pets unattended in your vehicle. Additionally, the temperature inside a closed vehicle on a warm day can quickly become high enough to cause a significant risk of injury or death to people and pets.**

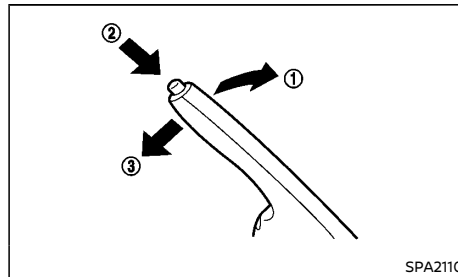

To apply the parking brake, pull the parking brake lever up ①.

To release the parking brake, firmly depress

and hold the foot brake pedal. Pull up the parking brake lever slightly, push the button ② and lower the lever completely ③.

Before driving, be sure that the brake warning light has turned off.

**MEMO**

# 4 Monitor, heater and air conditioner, and audio system

NissanConnect Owner's Manual (if equipped) .....	4-2	Manual air conditioner .....	4-15
Safety precautions .....	4-2	Automatic air conditioner .....	4-18
Intelligent around view monitor (if equipped) .....	4-3	Servicing air conditioner .....	4-20
Intelligent Around View Monitor		Audio system .....	4-20
system operation .....	4-4	Audio operation precautions .....	4-20
Difference between predictive and		AM-FM Radio with USB (Universal Serial Bus)	
actual distances .....	4-5	connection port .....	4-26
How to park with predictive course lines .....	4-7	Steering wheel mounted controls (if equipped) .....	4-30
How to switch the display .....	4-8	USB (Universal Serial Bus) connection port/AUX	
Adjusting the screen .....	4-8	(auxiliary) input jack .....	4-31
Intelligent Around View Monitor		USB memory device care .....	4-31
system limitations .....	4-9	Antenna .....	4-32
System Maintenance .....	4-10	Window antenna (if equipped) .....	4-32
Moving Object Detection (MOD) function		Rod antenna (if equipped) .....	4-32
(if equipped) .....	4-11	Car phone or CB radio .....	4-33
MOD system operation .....	4-11	Bluetooth® Hands-Free Phone System	
Turning the MOD system on or off .....	4-12	(if equipped) .....	4-33
MOD system limitations .....	4-12	Regulatory information .....	4-33
System maintenance .....	4-13	Using the system .....	4-33
Ventilators .....	4-13	Getting Started .....	4-34
Center ventilators .....	4-13	Using the system .....	4-34
Side ventilators .....	4-13	Volume control .....	4-35
Heater and air conditioner .....	4-14	Bluetooth® settings .....	4-35
Operating tips (for automatic air conditioner) .....	4-14		

## NISSANCONNECT OWNER'S MANUAL (if equipped)

For models with NissanConnect System, refer to the NissanConnect Owner's Manual that includes the following information.

Available functions may vary depending on the models and specifications.

- Audio
- Hands-free phone
- Apple CarPlay
- Android Auto
- Information and settings viewable on NissanConnect

## SAFETY PRECAUTIONS



### WARNING:

- **Do not adjust the heater and air conditioner controls or audio controls while driving so that full attention may be given to vehicle operation.**
- **If you noticed any foreign objects entering the system hardware, spilled liquid on the system, or noticed smoke or fumes coming out from the system, or any other unusual operation is observed, stop using the system immediately and contact the nearest NISSAN dealer. Ignoring such conditions may lead to an accident, fire or electric shock.**
- **Do not disassemble or modify this system. If you do, it may lead to an accident, fire, or electric shock.**



### CAUTION:

**Do not use the system when the engine is not running for extended periods of time to prevent battery discharge.**

## INTELLIGENT AROUND VIEW MONITOR (if equipped)

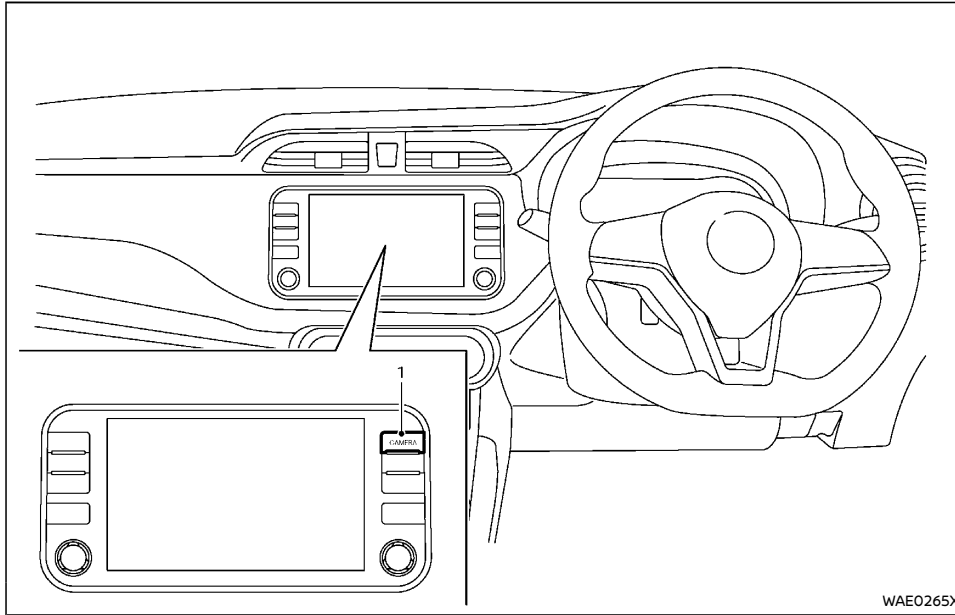

Right-Hand Drive (RHD) model

1. CAMERA button



### WARNING:

- Failure to follow the warnings and instructions for the proper use of the Intelligent Around View Monitor system could result in serious injury or death.
- The Intelligent Around View Monitor is a convenience feature but it is not a substitute for proper vehicle operation because it has areas where objects cannot be viewed. The four corners of the vehicle in particular, are areas where objects do not always appear in the bird's-eye, front, or rear views. Always check your surroundings to be sure that it is safe to move before operating the vehicle. Always operate the vehicle slowly.
- The driver is always responsible for safety during parking and other maneuvers.



### CAUTION:

**Do not scratch the camera lens when cleaning dirt or snow from the front of the camera.**

The Intelligent Around View Monitor system is designed as an aid to the driver in situations such as slot parking or parallel parking.

The monitor displays various views of the position of the vehicle in a split screen format. Not all views are available at all times.

### Available views:

- Front view  
An approximately 150-degree view of the front of the vehicle.
- Rear view  
An approximately 150-degree view of the rear of the vehicle.
- Bird's-eye view  
The surrounding views of the vehicle from above.
- Front-side view  
The view around and ahead of the front passenger's side wheel.

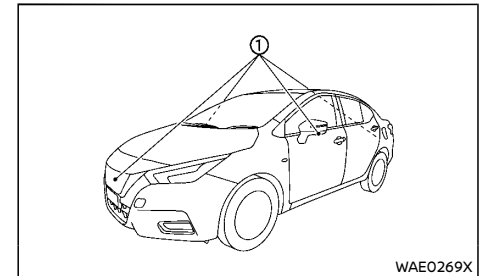

To display the multiple views, the Intelligent Around View Monitor system uses cameras ①

located in the front grille, on the vehicle's outside mirrors and one just above the vehicle's license plate.

## INTELLIGENT AROUND VIEW MONITOR SYSTEM OPERATION

With the ignition switch in the "ON" position, move the shift lever to the "R" (Reverse) position or push the CAMERA button to operate the Intelligent Around View Monitor.

The screen displayed on the Intelligent Around View Monitor will automatically return to the previous screen 3 minutes after the CAMERA button has been pushed with the shift lever in a position other than the "R" (Reverse) position.

### Available views



#### WARNING:

- The distance guide lines and the vehicle width lines should be used as a reference only when the vehicle is on a paved, level surface. The apparent distance viewed on the monitor may be different than the actual distance between the vehicle and displayed objects.
- Use the displayed lines and the bird's-eye view as a reference. The lines and the bird's-eye view are greatly affected by the number of occupants, cargo, fuel level, vehicle position, road condition and road grade.
- If the tires are replaced with different sized tires, the predictive course lines and the bird's-eye view may be displayed incorrectly.
- When driving the vehicle up a hill, objects viewed in the monitor are further than they appear. When driving the vehicle

down a hill, objects viewed in the monitor are closer than they appear.

- Objects in the rear view will appear visually opposite compared to when viewed in the monitor and outside mirrors.
- Use the mirrors or actually look to properly judge distances to other objects.
- On a snow-covered or slippery road, there may be a difference between the predictive course lines and the actual course line.
- The vehicle width and predictive course lines are wider than the actual width and course.
- The displayed lines will appear slightly off to the right, because the rearview camera is not installed in the rear center of the vehicle.

### Front and rear view:

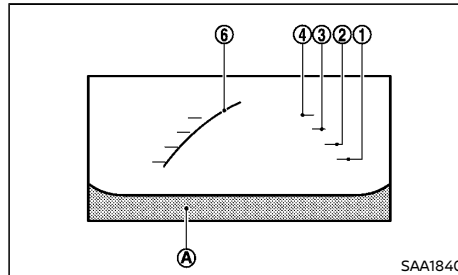

Front view

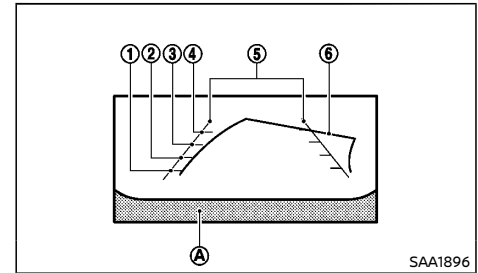

Rear view

Guiding lines, which indicate the vehicle width and distances to objects with reference to the vehicle body line (A), are displayed on the monitor.

#### Distance guide lines:

Indicate distances from the vehicle body.

- Red line ① : approximately 0.5 m (1.5 ft)
- Yellow line ② : approximately 1 m (3 ft)
- Green line ③ : approximately 2 m (7 ft)
- Green line ④ : approximately 3 m (10 ft)

#### Vehicle width guide lines ⑤ :

Indicate the vehicle width when backing up.

#### Predictive course lines ⑥ :

Indicate the predictive course when operating the vehicle. The predictive course lines will move depending on how much the steering wheel is turned. The predictive course lines in the rear view will not be displayed while the steering wheel is in the straight ahead position.

The front view will not be displayed when the vehicle speed is above 10 km/h (6 MPH).



**NOTE:**

When the monitor displays the front view and the steering wheel turns about 90 degrees or less from the neutral position, both the right and left predictive course lines ⑥ are displayed. When the steering wheel turns about 90 degrees or more, the predictive course line is displayed only on the opposite side of the turn.

**Bird's-eye view:**

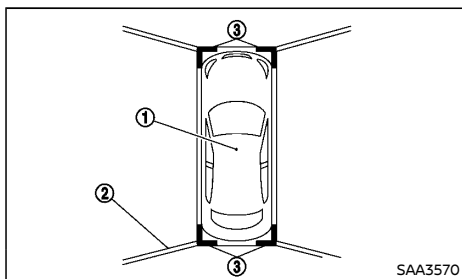

The bird's-eye view shows the overhead view of the vehicle which helps confirm the vehicle position.

The vehicle icon ① shows the position of the vehicle. Note that the apparent distance between objects viewed in the bird's-eye view may differ somewhat from the actual distance to the vehicle.

The areas that the cameras cannot cover ② are indicated in black. The non-viewable area ② is highlighted in yellow for 3 seconds after the bird's-eye view is displayed. It will be shown only the first time after the ignition switch is placed in the "ON" position.

In addition, the non-viewable corners ③ are displayed in red and blink for the first 3 seconds

to remind the driver to be cautious.



**WARNING:**

- Objects in the bird's-eye view will appear further than the actual distance.
- Tall objects, such as a curb or vehicle, may be misaligned or not displayed at the seam of the views.
- Objects that are above the camera cannot be displayed.
- The view for the bird's-eye view may be misaligned when the camera position alters.
- A line on the ground may be misaligned and is not seen as being straight at the seam of the views. The misalignment will increase as the line proceeds away from the vehicle.

**Front-side view:**

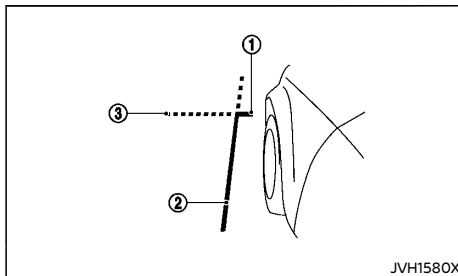

**Guiding lines:**

Guiding lines that indicate the approximate width and the front end of the vehicle are displayed on the monitor.

The front-of-vehicle line ① shows the front part

of the vehicle.

The side-of-vehicle line ② shows the approximate vehicle width including the outside mirror.

The extensions ③ of both the front ① and side ② lines are shown with a green dotted line.

\* The layout in the illustration shows that of the Right-Hand Drive (RHD) model. For the Left-Hand Drive (LHD) model, the layout will be the opposite.

**DIFFERENCE BETWEEN PREDICTIVE AND ACTUAL DISTANCES**

The displayed guide lines and their locations on the ground are for approximate reference only. Objects on uphill or downhill surfaces or projecting objects will be actually located at distances different from those displayed in the monitor relative to the guide lines (refer to illustrations). When in doubt, turn around and view the objects as you are backing up, or park and exit the vehicle to view the positioning of objects behind the vehicle.

### Backing up on a steep uphill

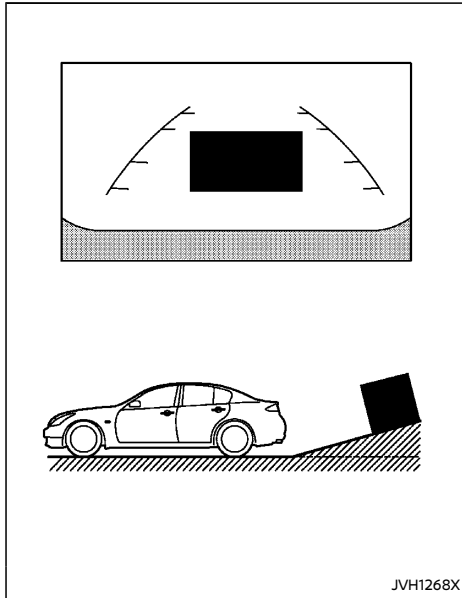

When moving the vehicle up a hill, the distance guide lines and the vehicle width guide lines are shown closer than the actual distance. Note that any object on the hill is further than it appears on the monitor.

### Backing up on a steep downhill

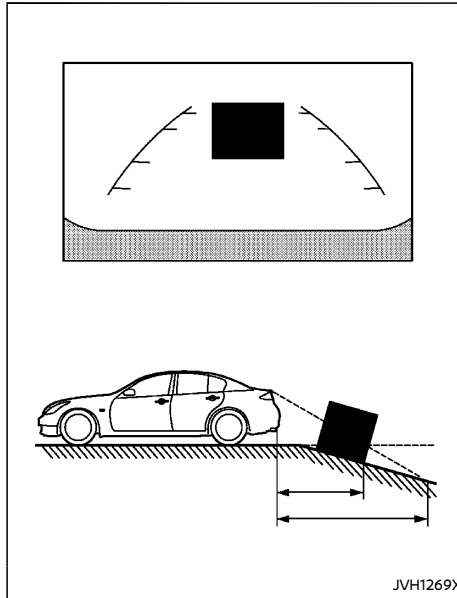

When moving the vehicle down a hill, the distance guide lines and the vehicle width guide lines are shown further than the actual distance. Note that any object on the hill is closer than it appears on the monitor.

### Backing up near a projecting object

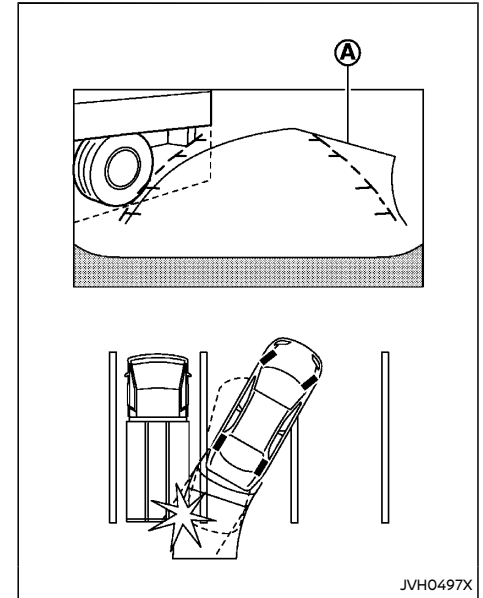

The predictive course lines Ⓐ do not touch the object in the display. However, the vehicle may hit the object if it projects over the actual moving course.

## Backing up behind a projecting object

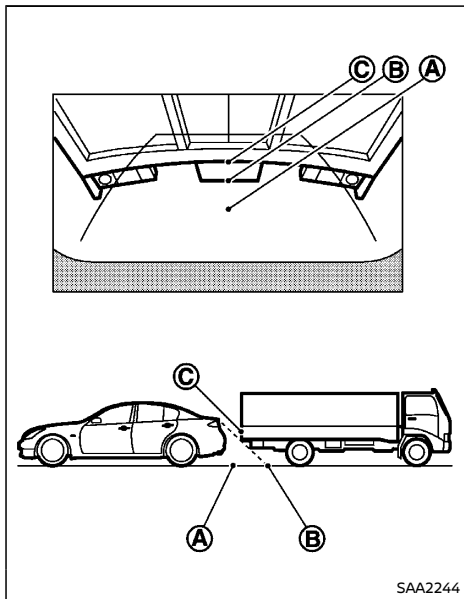

The position © is shown farther than the position Ⓐ in the display. However, the position © is actually at the same distance as the position Ⓐ. The vehicle may hit the object when backing up to the position Ⓐ if the object projects over the actual backing up course.

## HOW TO PARK WITH PREDICTIVE COURSE LINES

### ⚠ WARNING:

- If the tires are replaced with different sized tires, the predictive course lines may be displayed incorrectly.
- On a snow-covered or slippery road, there may be a difference between the predictive course lines and the actual course line.
- If the battery is disconnected or becomes discharged, the predictive course lines may be displayed incorrectly. If this occurs, please perform the following procedures:
  - Turn the steering wheel from lock to lock while the engine is running.
  - Drive the vehicle on a straight road for more than 5 minutes.

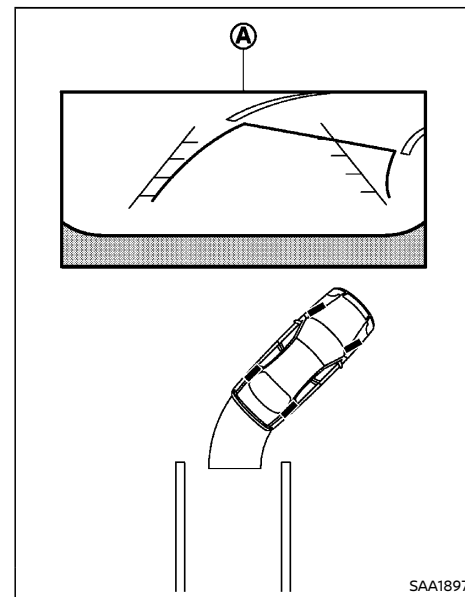

1. Visually check that the parking space is safe before parking your vehicle.
2. The rear view of the vehicle is displayed on the screen Ⓐ as illustrated when the shift lever is moved to the "R" (Reverse) position.

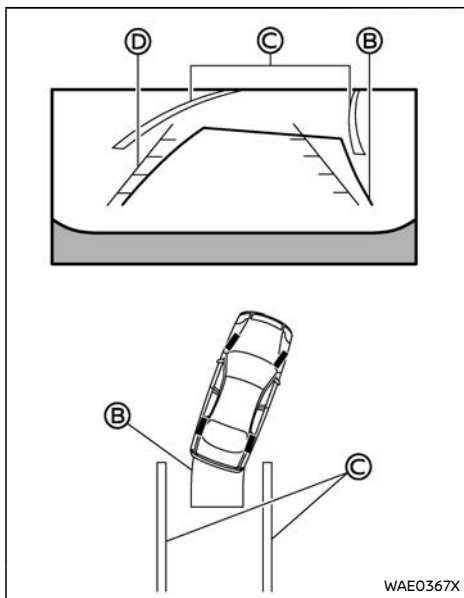

## HOW TO SWITCH THE DISPLAY

With the ignition switch in the "ON" position, push the CAMERA button or move the shift lever to the "R" (Reverse) position to operate the Intelligent Around View Monitor.

The Intelligent Around View Monitor displays different split screen views depending on the position of the shift lever. Push the CAMERA button to switch between the available views.

If the shift lever is in the "R" (Reverse) position, the available views are:

- Bird's-eye view/rear view split screen
- Front-side view/rear view split screen
- Rear view screen

If the shift lever is in the "P" (Park) or "D" (Drive) position (Continuously Variable Transmission model) or the shift lever is out of the "R" (Reverse) position (Manual Transmission model), the available views are:

- Bird's-eye view/front view split screen
- Front-side view/front view split screen

The display will switch from the Intelligent Around View Monitor screen when:

- The shift lever is in the "D" (Drive) position (CVT model) or the shift lever is out of the "R" (Reverse) position (MT model) and the vehicle speed increases above approximately 10 km/h (6 MPH).
- A different screen is selected.

3. Slowly back up the vehicle adjusting the steering wheel so that the predictive course lines (B) enter the parking space (C).
4. Maneuver the steering wheel to make the vehicle width guide lines (B) parallel to the parking space (C) while referring to the predictive course lines.
5. When the vehicle is parked in the space completely, move the shift lever to the "P" (Park) position (CVT model) or to an appropriate gear (MT model) and apply the parking brake.

## ADJUSTING THE SCREEN

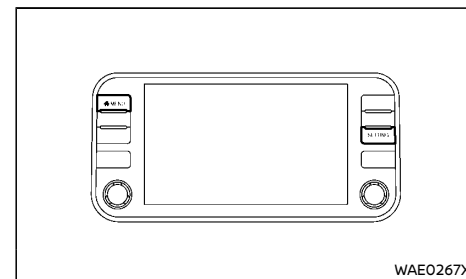

1. Push the MENU button and touch the "Settings" key, or push the SETTING button.
2. Touch the "Camera" key and then touch the "Display Settings" key.
3. Touch the "Brightness", "Contrast", "Tint", "Color" or "Black Level" key.
4. Adjust the item by touching the "-" or "+" key on the touch screen display.

## INTELLIGENT AROUND VIEW MONITOR SYSTEM LIMITATIONS

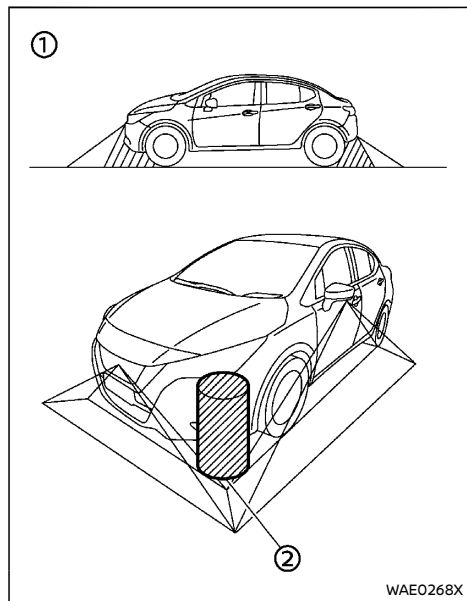

### WARNING:

Listed below are the system limitations for Intelligent Around View Monitor. Failure to operate the vehicle in accordance with these system limitations could result in serious injury or death.

- Do not use the Intelligent Around View Monitor with the outside mirrors in the stored position, and make sure that the

trunk is securely closed when operating the vehicle using the Intelligent Around View Monitor.

- The apparent distance between objects viewed on the Intelligent Around View Monitor differs from the actual distance.
- The cameras are installed on the front grille, the outside mirrors and above the rear license plate. Do not put anything on the vehicle that covers the cameras.
- When washing the vehicle with high pressure water, be sure not to spray it around the cameras. Otherwise, water may enter the camera unit causing water condensation on the lens, a malfunction, fire or an electric shock.
- Do not strike the cameras. They are precision instruments. Doing so could cause a malfunction or cause damage resulting in a fire or an electric shock.

There are some areas where the system will not show objects and the system does not warn of moving objects. When in the front or rear view display, an object below the bumper or on the ground may not be viewed ①. When in the bird's-eye view, a tall object near the seam ② of the camera viewing areas will not appear in the monitor.

The following are operating limitations and do not represent a system malfunction:

- There may be a delay when switching between views.
- When the temperature is extremely high or low, the screen may not display objects clearly.
- When strong light directly shines on the camera, objects may not be displayed clearly.

- The screen may flicker under fluorescent light.
- The colors of objects on the Intelligent Around View Monitor may differ somewhat from the actual color of objects.
- Objects on the Intelligent Around View Monitor may not be clear and the color of the object may differ in a dark environment.
- There may be differences in sharpness between each camera view of the bird's-eye view.
- Do not use wax on the camera lens. Wipe off any wax with a clean cloth that has been dampened with a diluted mild cleaning agent, then wipe with a dry cloth.

### System temporarily unavailable

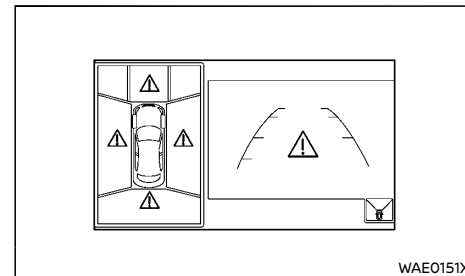

When the "▲" icon is displayed on the screen, there are abnormal conditions in the Intelligent Around View Monitor. This will not hinder normal driving operation but the system should be inspected. It is recommended that you visit a NISSAN dealer for this service.

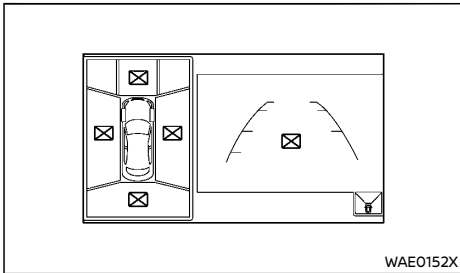

When the “X” icon is displayed on the screen, the camera image may be receiving temporary electronic disturbances from surrounding devices. This will not hinder normal driving operation but the system should be inspected if it occurs frequently. It is recommended that you visit a NISSAN dealer for this service.

\* The layout in the illustration shows that of the Right-Hand Drive (RHD) model. For the Left-Hand Drive (LHD) model, the layout will be the opposite.

#### SYSTEM MAINTENANCE

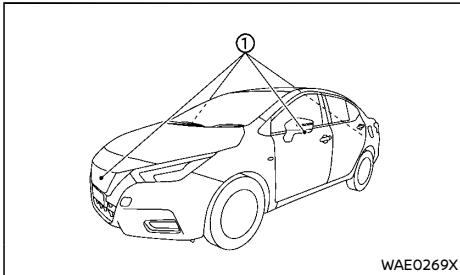

#### CAUTION:

- Do not use alcohol, benzine or thinner to clean the camera. This will cause discoloration.
- Do not damage the cameras as the monitor screen may be adversely affected.

If dirt, rain or snow accumulates on any of the cameras ①, the Intelligent Around View Monitor may not display objects clearly. Clean the camera by wiping with a cloth dampened with a diluted mild cleaning agent and then wiping with a dry cloth.

## MOVING OBJECT DETECTION (MOD) FUNCTION (if equipped)

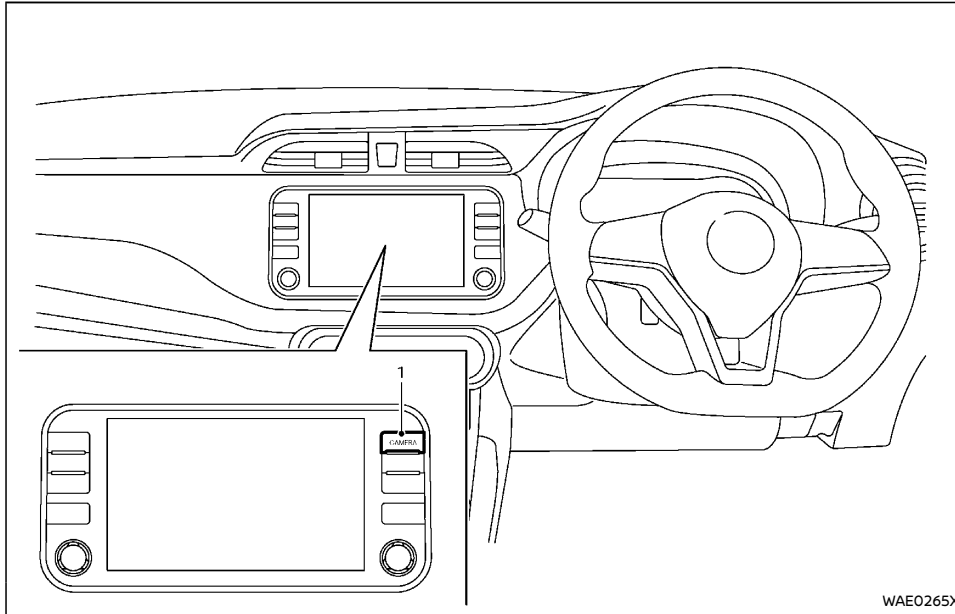

Right-Hand Drive (RHD) model

### 1. CAMERA button



#### WARNING:

- Failure to follow the warnings and instructions for proper use of the Moving Object Detection (MOD) system could result in serious injury or death.
- The MOD system is not a substitute for proper vehicle operation and does not prevent contact with the objects surrounding the vehicle. When maneuvering,

always use the outside mirror and inside rearview mirror and turn and look to check the surroundings to make sure it is safe to maneuver.

- The system is deactivated at speeds above 8 km/h (5 MPH). It is reactivated at lower speeds.
- The MOD system is not designed to detect surrounding stationary objects.

The MOD system can inform the driver of moving objects near the vehicle when driving

out of garages, maneuvering in parking lots and in other such instances.

The MOD system detects moving objects by using image processing technology on the image shown in the display.

### MOD SYSTEM OPERATION

The MOD system will turn on automatically under the following conditions:

- When the shift lever is in the "R" (Reverse) position.
- When the CAMERA button is pushed to activate the camera view on the display.
- When vehicle speed decreases below approximately 8 km/h (5 MPH) and the camera screen is displayed.

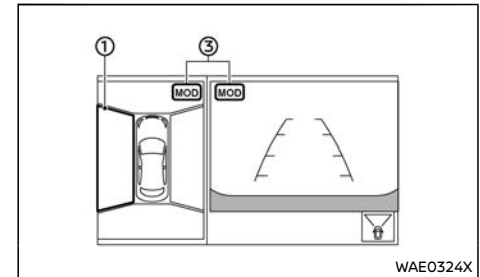

Front and bird's-eye views

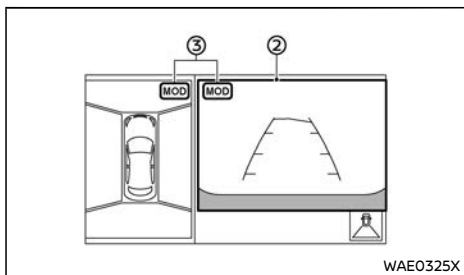

Rear and bird's-eye views

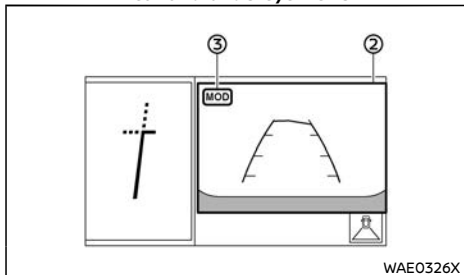

Rear and front-side views

The MOD system operates in the following conditions when the camera view is displayed:

- When the shift lever is in the "P" (Park) or "D" (Drive) position (Continuously Variable Transmission model) or the shift lever is out of the "R" (Reverse) position (Manual Transmission model) and the vehicle is stopped, the MOD system detects moving objects in the bird's-eye view. The MOD system will not operate if either door is opened.
- When the shift lever is in the "D" (Drive) position (CVT model) or the shift lever is out of the "R" (Reverse) position (MT model) and

the vehicle speed is below approximately 8 km/h (5 MPH), the MOD system detects moving objects in the front view.

- When the shift lever is in the "R" (Reverse) position and the vehicle speed is below approximately 8 km/h (5 MPH), the MOD system detects moving objects in the rear view. The MOD system will not operate if the trunk is opened.

The MOD system does not detect moving objects in the front-side view. The MOD icon is not displayed on the screen when in this view.

When the MOD system detects moving objects near the vehicle, a chime will be heard and a yellow frame will be displayed on the view where the objects are detected. While the MOD system continues to detect moving objects, the yellow frame continues to be displayed.

#### NOTE:

**While the Rear Cross Traffic Alert chime (if equipped) is beeping, the MOD system does not chime**

In the bird's-eye view, the yellow frame ① is displayed on each camera image (front, rear, right, left) depending on where moving objects are detected.

The yellow frame ② is displayed on each view in the front view and rear view modes.

A blue MOD icon ③ is displayed in the view where the MOD system is operative. A gray MOD icon ③ is displayed in the view where the MOD system is not operative.

If the MOD system is turned off, the MOD icon ③ is not displayed.

\* The layout in the illustration shows that of the Right-Hand Drive (RHD) model. For the Left-Hand Drive (LHD) model, the layout will be the opposite.

## TURNING THE MOD SYSTEM ON OR OFF

The MOD system can be turned on and off.

See "Driver Assistance" (P.2-20).

## MOD SYSTEM LIMITATIONS



### WARNING:

Listed below are the system limitations for the MOD. Failure to operate the vehicle in accordance with these system limitations could result in serious injury or death.

- Excessive noise (for example, audio system volume or open vehicle window) will interfere with the chime sound, and it may not be heard.
- The MOD system performance will be limited according to environmental conditions and surrounding objects such as:
  - When there is low contrast between background and the moving objects.
  - When there is a blinking source of light.
  - When strong light such as another vehicle's headlight or sunlight is present.
  - When there is dirt, water drops or snow on the camera lens.
  - When the position of the moving objects in the display is not changed.
- The MOD system might detect flowing water droplets on the camera lens, white smoke from the muffler, moving shadows, etc.
- The MOD system may not function properly depending on the speed, direction, distance or shape of the moving objects.



- If your vehicle sustains damage to the parts where the camera is installed, leaving it misaligned or bent, the sensing zone may be altered and the MOD system may not detect objects properly.
- When the temperature is extremely high or low, the screen may not display objects clearly. This is not a malfunction.

#### NOTE:

The blue icon will change to orange when the system is malfunctioning.

If the icon continues to illuminate in orange, have the MOD system checked. It is recommended that you visit a NISSAN dealer for this service.

#### SYSTEM MAINTENANCE

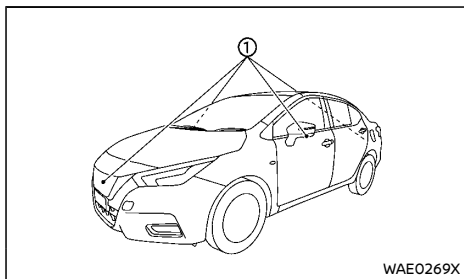

#### CAUTION:

- Do not use alcohol, benzine or thinner to clean the camera. This will cause discoloration.
- Do not damage the cameras as the monitor screen may be adversely affected.

If dirt, rain or snow accumulates on any of the cameras ①, the MOD system may not operate properly. Clean the camera by wiping with a cloth dampened with a diluted mild cleaning agent and then wiping with a dry cloth.

## VENTILATORS

### CENTER VENTILATORS

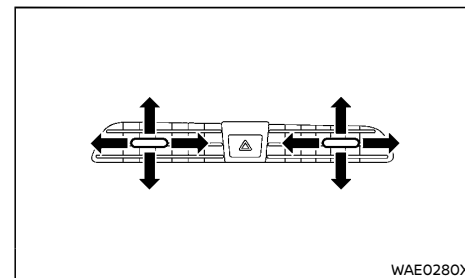

Adjust the air flow direction of the ventilators by moving the center knob (up/down, left/right) until the preferred position is achieved.

### SIDE VENTILATORS

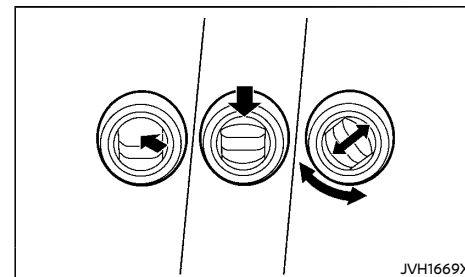

Open or close the vents, and adjust the air flow direction of ventilators as illustrated.

## HEATER AND AIR CONDITIONER



### WARNING:

- The heater and air conditioner operates only when the engine is running.
- Children or adults who would normally require supervision should never be left alone in the vehicle. Pets should not be left alone either. They could unknowingly activate switches or controls and inadvertently become involved in a serious accident and injure themselves. On hot, sunny days, temperatures in a closed vehicle could quickly become high enough to cause severe or possibly fatal injuries to people or animals.
- Do not use the recirculation mode for long periods as it may cause the interior air to become stale and the windows to fog up.
- Do not adjust the heating and air conditioning controls while driving so that full attention may be given to vehicle operation.

The heater and air conditioner operate when the engine is running. The air blower will operate even if the engine is turned off and the ignition switch is in the "ON" position.

### NOTE:

- Odors from inside and outside the vehicle can build up in the air conditioner unit. Odor can enter the passenger compartment through the vents.
- When parking, set the heater and air conditioner to turn off air recirculation to allow fresh air into the passenger compartment. This should help reduce odors inside the vehicle.

### For models with Idling Stop System:

When the engine is stopped by the Idling Stop System, cooling, heating (if equipped) and dehumidifying functions will be deactivated.

To avoid cooling, heating (if equipped) and dehumidifying functions from being deactivated, turn off the Idling Stop mode by pushing the Idling Stop OFF switch. For more details, see "Idling Stop System" (P.5-15).

### OPERATING TIPS (for automatic air conditioner)

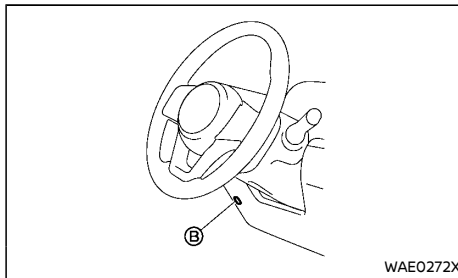
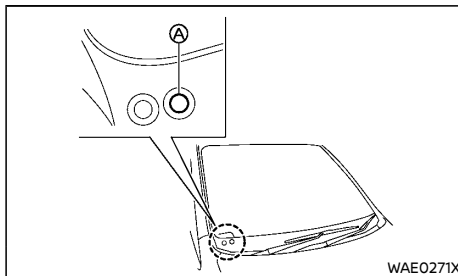

When the engine coolant temperature and outside air temperature are low, the air flow

from the foot outlets may not operate immediately. However, this is not a malfunction. After the coolant temperature warms up, the air flow from the foot outlets will operate normally.

The sensors (A) and (B), located on the instrument panel, help maintain a constant temperature. Do not put anything on or around the sensors.

\* The layout in the illustrations shows that of the Right-Hand Drive (RHD) model. For the Left-Hand Drive (LHD), the layout will be the opposite.



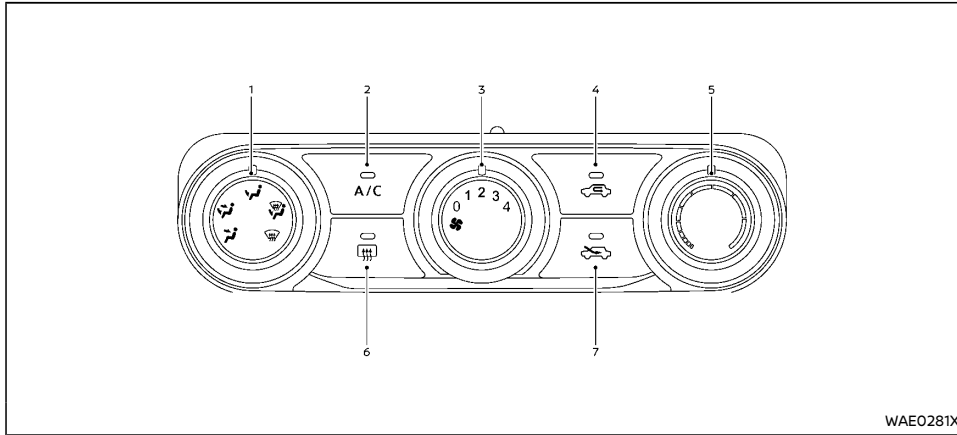

## MANUAL AIR CONDITIONER

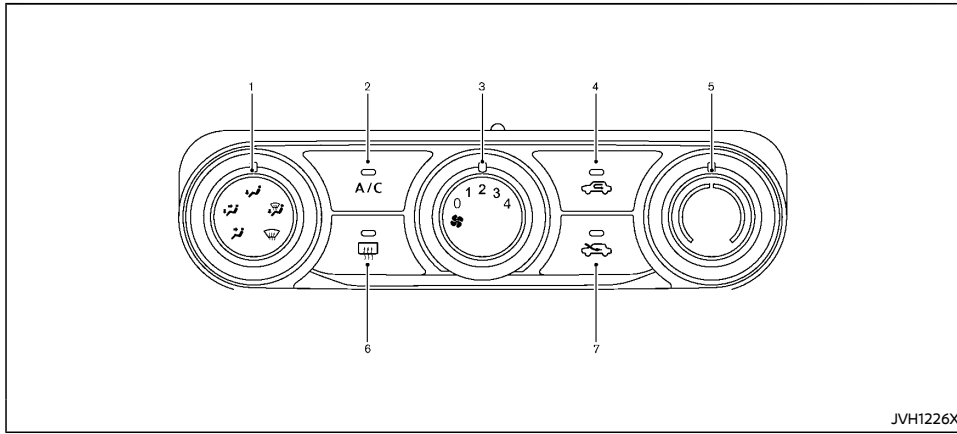

Type A (model without heater)



Type B (model with heater)

1. Air flow control dial
2. "A/C" button
3. Fan speed control "  " dial
4. Air recirculation "  " button
5. Temperature control dial
6. Rear defogger "  " button (See "Defogger switch" (P.2-34).)
7. Outside air circulation "  " button

## Controls

### Turning system on/off:

To turn on the system, turn the fan speed control "  " dial out of the off (0) position. Turn the dial to the off (0) position to turn off the system.

### Fan speed control:

Turn the fan speed control "  " dial clockwise to increase the fan speed.

Turn the fan speed control "  " dial counterclockwise to decrease the fan speed.

### Temperature control:





Turn the temperature control dial to set the desired temperature.

For Type A: Turn the dial in clockwise direction to select more cool temperature. Turn the dial in counterclockwise direction to select less cool temperature.



For Type B: Turn the dial between the middle and the right position to select the hot temperature. Turn the dial between the middle and the left position to select the cool temperature.

### Air flow control:

Turn the air flow control dial to select the air flow outlets.

-  — Air flows mainly from the center and side ventilators.
-  — Air flows mainly from the center and side ventilators and foot outlets.
-  — Air flows mainly from the foot outlets.
-  — Air flows mainly from the defogger and foot outlets.
-  — Air flows mainly from the defogger.

### Air intake control:

- Push the outside air circulation "  " button. (The indicator light will illuminate.) The air flow is drawn from outside the vehicle.
- Push the air recirculation "  " button. (The indicator light will illuminate.) The air will recirculate inside the vehicle.



### A/C (Air Conditioner) operation:

Push the "A/C" button to turn the air conditioner on or off. When the air conditioner is on, the indicator light on the "A/C" button illuminates.

### Heater operation (Type B)

#### Heating:



This mode is used to direct heated air from the foot outlets.

1. Push the outside air circulation "  " button for normal heating. (The indicator light will illuminate.)
2. Turn the air flow control dial to set "  " position.

3. Turn the fan speed control "  " dial to the desired position.
4. Turn the temperature control dial to the desired position between the middle and the hot (right) position.



#### Ventilation:

This mode directs outside air from the side and center ventilators.

1. Push the outside air circulation "  " button. (The indicator light will illuminate.)
2. Turn the air flow control dial to set "  " position.
3. Turn the fan speed control "  " dial to the desired position.
4. Turn the temperature control dial to the desired position.

#### Defrosting or defogging:



This mode directs the air to the defogger outlets to defrost/defog the windows.

1. Push the outside air circulation "  " button. (The indicator light will illuminate.)
2. Turn the fan speed control "  " dial to the desired position.
3. Turn the air flow control dial to the "  " position.
4. Turn the temperature control dial to the desired position between the middle and the hot (right) position.

To remove frost from the windshield quickly, turn the temperature control dial to the maximum hot (right) position and the fan speed control "  " dial to the maximum position.



#### Bi-level heating:

This mode directs cool air from the side/center ventilators and warm air from the foot outlets. (When the temperature control dial is turned to the maximum hot (right) or cool (left) position, the temperatures of the air from the side/center ventilators and the foot outlets will be the same.)

1. Push the outside air circulation "  " button. (The indicator light will illuminate.)
2. Turn the air flow control dial to set "  " position.
3. Turn the fan speed control "  " dial to the desired position.
4. Turn the temperature control dial to the desired position.

#### Heating and defogging:

This mode heats the interior and defogs the windows.

1. Push the outside air circulation "  " button. (The indicator light will illuminate.)
2. Turn the air flow control dial to set "  " position.
3. Turn the fan speed control "  " dial to the desired position.
4. Turn the temperature control dial to the maximum hot (right) position.



Clear snow and ice from the wiper blades and air inlet in front of the windshield. This improves heater operation.



#### Air conditioner operation



The air conditioner system should be operated for approximately 10 minutes at least once a month. This helps prevent damage to the air conditioner system due to a lack of lubrication. Keep the windows closed while the air conditioner is in operation.

#### Cooling:

This mode is used to cool and dehumidify the air.

1. Push the outside air circulation "  " button. (The indicator light will illuminate.)
2. Turn the air flow control dial to set "  " position.
3. Turn the fan speed control "  " dial to the desired position.
4. Push the "A/C" button. (The indicator light will illuminate.)
5. Turn the temperature control dial to the desired position.

For quick cooling when the outside temperature is high, push the air recirculation "  " button. The indicator light on the air recirculation "  " button will come on.



Push the outside air circulation "  " button for normal cooling. The indicator light on the outside air circulation "  " button will come on.

After parking in the sun, drive for two or three minutes with the windows open to vent hot air from the passenger compartment. Then, close the windows. This allows the interior air to cool faster.

A visible mist may be seen coming from the ventilators in hot, humid conditions as the air is cooled rapidly. This does not indicate a malfunction.



### Dehumidified heating (Type B):

This mode is used to heat and dehumidify the air.

1. Push the outside air circulation “” button. (The indicator light will illuminate.)
2. Turn the air flow control dial to set “” position.
3. Turn the fan speed control “” dial to the desired position.
4. Push the “A/C” button. (The indicator light will illuminate.)
5. Turn the temperature control dial to the desired position between the middle and the hot (right) position.

### Dehumidified defogging:

This mode is used to defog the windows and dehumidify the air.

1. Push the outside air circulation “” button. (The indicator light will illuminate.)
2. Turn the fan speed control “” dial to the desired position.
3. Turn the air flow control dial to set “” position.
4. Push the “A/C” button. (The indicator light will illuminate.)
5. Turn the temperature control dial to the desired position.



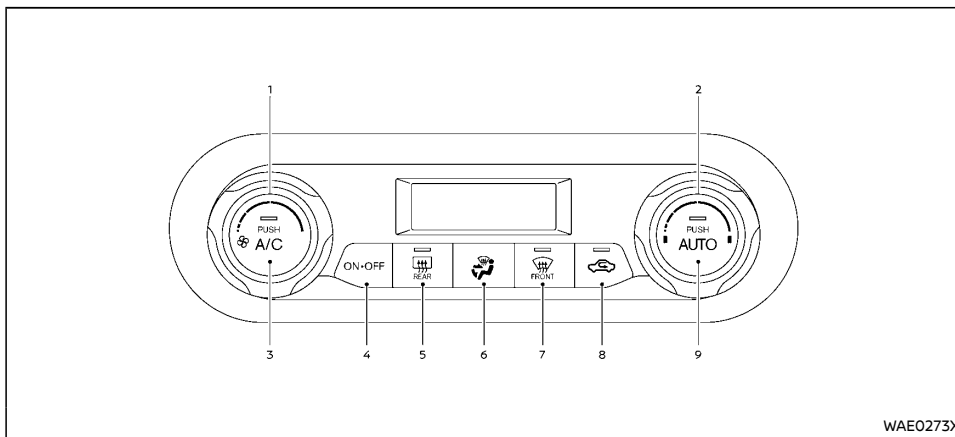

### AUTOMATIC AIR CONDITIONER

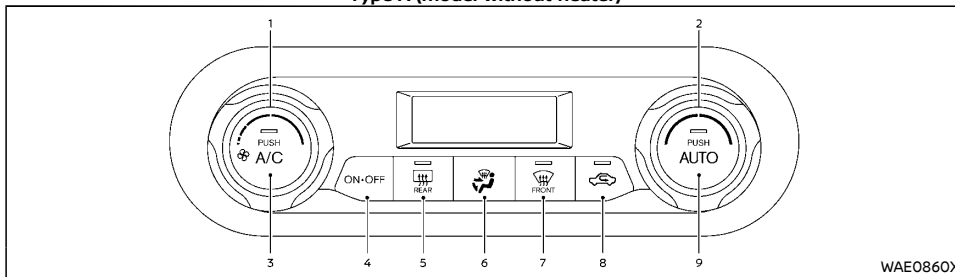

Type A (model without heater)





Type B (model with heater)

1. Fan speed control "  " dial
2. Temperature control dial
3. "A/C" button
4. "ON-OFF" button
5. Rear defogger "  " button (See "Defogger switch" (P.2-34).)
6. Air flow control button
7. Front defogger "  " button
8. Air intake control "  " button
9. "AUTO" button

### Automatic operation (AUTO)



The AUTO mode may be used year-round as the system automatically controls to a constant temperature, air flow distribution and fan speed.

#### Cooling:

1. Push the "AUTO" button. (The "AUTO" indicator light will illuminate.)
2. If the "A/C" indicator light is not illuminated, push the "A/C" button. (The "A/C" indicator light will illuminate.)
3. Turn the temperature control dial to set the desired temperature.
4. Push the air intake control "  " button for approximately 2 seconds. The "  " indicator light will flash, and then the air intake will be controlled automatically.

A visible mist may be seen coming from the ventilators in hot, humid conditions as the air is cooled rapidly. This does not indicate a malfunction.

### Dehumidified heating (Type B):

1. Push the "AUTO" button. (The "AUTO" indicator light will illuminate.)
2. If the "A/C" indicator light is not illuminated, push the "A/C" button. (The "A/C" indicator light will illuminate.)
3. Turn the temperature control dial to set the desired temperature.
4. Push the air intake control "  " button for approximately 2 seconds. The "  " indicator light will flash, and then the air intake will be controlled automatically.

### Heating (A/C OFF) (Type B):



The air conditioner does not activate in this mode. Use this mode when you only need to heat.

1. Push the "AUTO" button. (The "AUTO" indicator light will illuminate.)
2. If the "A/C" indicator light is illuminated, push the "A/C" button. (The "A/C" indicator light will turn off.)
3. Turn the temperature control dial to set the desired temperature.



#### NOTE:

- **Do not set the temperature lower than the outside air temperature or the system may not work properly.**
- **Not recommended if windows fog up.**

### Dehumidified defrosting/defogging:

1. Push the front defogger "  " button. (The "  " indicator light will illuminate.)
2. Turn the temperature control dial to set the desired temperature.
  - To quickly remove fog from the windshield, set the temperature using the temperature control dial and set the fan

speed using the fan speed control "  " dial at their maximum levels.

- After the windshield is cleared, push the front defogger "  " button again.
- When the front defogger "  " button is pushed, the air conditioner will automatically turn on when the outside air temperature is above -2°C (28°F) to defog the windshield. The outside air circulation mode will be selected to improve the defogging performance.

### Manual operation

The manual mode can be used to control the heater (if equipped) and air conditioner to your preferred settings.





#### Fan speed control:

Turn the fan speed control "  " dial clockwise to increase the fan speed.

Turn the fan speed control "  " dial counter-clockwise to decrease the fan speed.

#### Air flow control:

Push the air flow control button to change the air flow outlets.



-  — Air flows mainly from the center and side ventilators.
-  — Air flows mainly from the center and side ventilators and foot outlets.
-  — Air flows mainly from the foot outlets.
-  — Air flows mainly from the defogger and foot outlets.

### Temperature control:

Turn the temperature control dial to set the desired temperature.

### Air intake control:

The air intake control mode will change each time the air intake control  button is pushed.

- When the indicator light is turned on, the air recirculates inside the vehicle.
- When the indicator light is turned off, the air flow is drawn from outside the vehicle.
- To switch to the automatic control mode, push the air intake control  button for approximately 2 seconds. The  indicator light will flash, and then the air intake will be controlled automatically.

### A/C (Air Conditioner) operation:

Push the "A/C" button to turn the air conditioner on or off. When the air conditioner is on, the "A/C" indicator light illuminates.

### Turning the system off:

Push the "ON-OFF" button to turn off the heater (if equipped) and air conditioner.

## SERVICING AIR CONDITIONER



### WARNING:

**The air conditioner system contains refrigerant under high pressure. To avoid personal injury, any air conditioner service should be done only by an experienced technician with the proper equipment.**

The air conditioner system in your vehicle is charged with a refrigerant designed with the environment in mind.

**This refrigerant will not harm the earth's**

**ozone layer.** However, it may contribute in a small part to global warming.

Special charging equipment and lubricant are required when servicing your vehicle's air conditioner. Using improper refrigerants or lubricants will cause severe damage to the air conditioner system. (See "Air conditioner system refrigerant and lubricant" (P.9-3).)

A NISSAN dealer will be able to service your environmentally friendly air conditioner system.

### Air conditioner filter

The air conditioner system is equipped with a filter which collects dust. To make sure the system cools, defogs and ventilates efficiently, replace the filter in accordance with the specified maintenance intervals listed in the separate maintenance booklet. To replace the filter, contact a NISSAN dealer.

The filter should be replaced if the air flow decreases significantly or if windows fog up easily when operating the air conditioner system.

## AUDIO SYSTEM

For models with NissanConnect System, see the separate NissanConnect Owner's manual.

## AUDIO OPERATION PRECAUTIONS



### WARNING:

**Do not adjust the audio system while driving so that full attention may be given to vehicle operation.**

### Radio

- Radio reception is affected by station signal strength, distance from radio transmitters, buildings, bridges, mountains and other external influences. Intermittent changes in reception quality normally are caused by these external influences.
- Using a cellular phone in or near the vehicle may influence radio reception quality.

## USB (Universal Serial Bus) connection port



### WARNING:

**Do not connect, disconnect or operate the USB device while driving. Doing so can be a distraction. If distracted you could lose control of your vehicle and cause an accident or serious injury.**



### CAUTION:

- **Do not force the USB device into the USB connection port. Inserting the USB device tilted or up-side-down into the port may damage the port. Make sure that the USB device is connected correctly into the USB connection port.**



- **Do not grab the USB connection port cover (if equipped) when pulling the USB device out of the port. This could damage the port and the cover.**
- **Do not leave the USB cable in a place where it can be pulled unintentionally. Pulling the cable may damage the port.**

The vehicle is not equipped with a USB device. USB devices should be purchased separately as necessary.

This system cannot be used to format USB devices. To format a USB device, use a personal computer.

This system supports various USB memory devices, USB hard drives and iPod players. Some USB devices may not be supported by this system. Partitioned USB devices may not be played correctly.

**General notes for USB use:**

Refer to your device manufacturer's owner information regarding the proper use and care of the device.

**Notes for iPod use:**

"Made for iPod", "Made for iPhone", and "Made for iPad" mean that an electronic accessory has been designed to connect specifically to iPod, iPhone, or iPad, respectively, and has been certified by the developer to meet Apple performance standards.

Apple is not responsible for the operation of this device or its compliance with safety and regulatory standards.

Please note that the use of this accessory with iPod, iPhone, or iPad may affect wireless performance.

iPad, iPhone, iPod, iPod classic, iPod nano, iPod shuffle, and iPod touch are trademarks of Apple Inc., registered in the U.S. and other countries.

Lightning is a trademark of Apple Inc.

- Improperly plugging in the iPod may cause a checkmark to be displayed on and off (flickering). Always make sure that the iPod is connected properly.
- Audiobooks may not play in the same order as they appear on an iPod.

**USB memory with MP3/WMA/AAC**

**Terms:**

- **MP3** — MP3 is short for Moving Pictures Experts Group Audio Layer 3. MP3 is the most well-known compressed digital audio file format. This format allows for near "CD quality" sound, but at a fraction of the size of normal audio files. MP3 conversion of an audio track from CD can reduce the file size by approximately 10:1 ratio Sampling: 44.1 kHz, Bit rate: 128 kbps) with virtually no perceptible loss in quality. MP3 compression removes the redundant and irrelevant parts of a sound signal that the human ear doesn't hear.
- **WMA** — Windows Media Audio (WMA)\* is a compressed audio format created by Microsoft as an alternative to MP3. The WMA codec offers greater file compression than the MP3 codec, enabling storage of more digital audio tracks in the same amount of space when compared to MP3s of the same level of quality.

This product is protected by certain intellectual property rights of Microsoft Corporation and third parties. Use or distribution of such technology outside of this product is prohibited without a license from Microsoft or an authorized Microsoft subsidiary and third parties.

- **AAC** — Advanced Audio Coding (AAC) is a compressed audio format. AAC offers greater file compression than MP3 and enables music file creation and storage at the same quality as MP3.
- **Bit rate** — Bit rate denotes the number of bits per second used by a digital music file. The size and quality of a compressed digital audio file is determined by the bit rate used when encoding the file.
- **Sampling frequency** — Sampling frequency is the rate at which the samples of a signal are converted from analog to digital (A/D conversion) per second.
- **Multisession** — Multisession is one of the methods for writing data to media. Writing data once to the media is called a single session, and writing more than once is called a multisession.
- **ID3/WMA Tag** — The ID3/WMA tag is the part of the encoded MP3 or WMA file that contains information about the digital music file such as song title, artist, album title, encoding bit rate, track time duration, etc. ID3 tag information is displayed on the Album/Artist/Track title line on the display.

\* Windows® and Windows Media® are registered trademarks and/or trademarks of Microsoft Corporation in the United States of America and/or other countries.

**Playback order:**

- The names of folders not containing MP3/WMA/AAC files are not shown in the display.
- If there is a file in the top level of the USB device, "Root" is displayed.
- The playback order is the order in which the files were written by the writing software, so the files might not be played in the desired order.

**Specification chart:**

	<b>Items</b>	<b>Specification</b>
USB Spec	Standard	USB 2.0 Full-speed
	Device class	Mass Storage Class
File system specification	File system type	FAT12, FAT16, FAT32
	Long file name support	VFAT
	Maximum cluster size	64 kB
	Maximum sector size	4 kB
	Maximum support device memory size	64 GB
	Max folder number support	512
	Max file in one folder	1024 (files and folders)
	Max file in device	65535 files
	Max directory depth	8
WMA Decoder	Standard	Windows Media Audio 7,8,9
	File extension	.wma/ .WMA
	Sampling rate (kHz)	48, 44.1, 32
	Bit rate (kbps)	32-192
MP3 Decoder	Standard	MPEG1,2,2.5 Layer3
	File extension	.MP3 / .mp3
	ID3 TAG Version	Version 2.4, 2.3, 2.2, 1.0
	Sampling rate (kHz)	48, 44.1, 32, 24, 22.05, 16, 11.025
	Bit rate (kbps)	8, 16, 24, 32, 40, 48, 56, 64, 80, 96, 112, 128, 144, 160, 192, 224, 256, 320 Variable bit-rates (VBR)
AAC Decoder	Standard	MPEG4 AAC
	File extension	.m4a / .M4A
	Sampling rate (kHz)	48, 44.1, 32, 24, 22.05, 16, 11.025
	Bit rate (kbps)	8 - 320

	Items	Specification
Display	Song number	1 to 999
	Folder number	1 to 512
	Playtime	00'00" - 99'59"
	ID3 tag language	English/Chinese (Chinese font GB18030)
Others	Insert USB to Play time	Less than 10 seconds
	Files changing time	Less than 2 seconds
Features	File Up/Down	Available
	Folder Up/Down	Available
	Folder Repeat	Available
	File Repeat	Available
	All Folders Random	Available
	Folder Random	Available
	FF/REW	5 times (3 seconds) 30 times (after 3 seconds)
	Scan	-
	Folder menu list	Available
	File menu list	Available
File search	Available	
Folder search	Available	

### Troubleshooting guide:

Symptom	Cause and Countermeasure
Cannot play	USB device was inserted incorrectly.
	Check if there is condensation inside the player, and if there is, wait until the condensation is gone (about 1 hour) before using the player.
	If there is a temperature increase error, the player will play correctly after it returns to the normal temperature.
	If there is a mixture of music files and compressed audio files on a USB device, only the music files will be played.
	Files with extensions other than ".M4A", ".MP3", ".WMA", ".m4a", ".mp3" or ".wma" cannot be played. In addition, the character codes and number of characters for folder names and file names should be in compliance with the specifications.
	Check if the file was generated in an irregular format. This may occur depending on the variation or the setting of compressed audio writing applications or other text editing applications.
	Check if the USB device is protected by copyright.
It takes a relatively long time before the music starts playing.	If there are many folder or file levels on the USB device, some time may be required before the music starts playing.
Music cuts off or skips	The writing software and hardware combination might not match, or the writing speed, writing depth, writing width, etc., might not match the specifications of the system. Try using the slowest writing speed.
Skipping with high bit rate files	Skipping may occur with large quantities of data, such as for high bit rate data.
Move immediately to the next song when playing.	If an unsupported compressed audio file has been given a supported extension like .MP3, or when playback is prohibited by copyright protection, the player will skip to the next song.
The songs do not play back in the desired order.	The playback order is the order in which the files were written by the writing software, so the files might not playback in the desired order.
	Random/Shuffle may be active on the audio system or on a USB device.

## Bluetooth® audio player

- Wireless LAN (Wi-Fi) and the Bluetooth® functions share the same frequency band (2.4 GHz). Using the Bluetooth® and the wireless LAN functions at the same time may slow down or disconnect communication and cause undesired noise. It is recommended that you turn off the wireless LAN (Wi-Fi) when using the Bluetooth® functions.
- Some Bluetooth® audio devices may not be used with this system. For detailed information about Bluetooth® audio devices that are available for use with this system, contact a NISSAN dealer.
- Before using a Bluetooth® audio system, the initial registration process for the audio device is necessary.
- Operation of the Bluetooth® audio system may vary depending on the audio device that is connected. Confirm the operation procedure before use.
- The playback of Bluetooth® audio will be paused under the following conditions. The playback will be resumed after the following conditions are completed.
  - while using a hands-free phone
  - while checking a connection with a cell phone
- The in-vehicle antenna for Bluetooth® communication is built in the system. Do not place the Bluetooth® audio device in an area surrounded by metal, far away from the system or in a narrow space where the device closely contacts the body or the seat. Otherwise, sound degradation or connection interference may occur.
- While a Bluetooth® audio device is connected through the Bluetooth® wireless connection, the battery power of the device

may discharge quicker than usual.

- This system is compatible with the Bluetooth® AV profile (A2DP and AVRCP).



Bluetooth® is a trademark owned by Bluetooth SIG, Inc., and licensed to Shenzhen Hangsheng Electronics Co., Ltd.

## AM-FM RADIO WITH USB (Universal Serial Bus) CONNECTION PORT

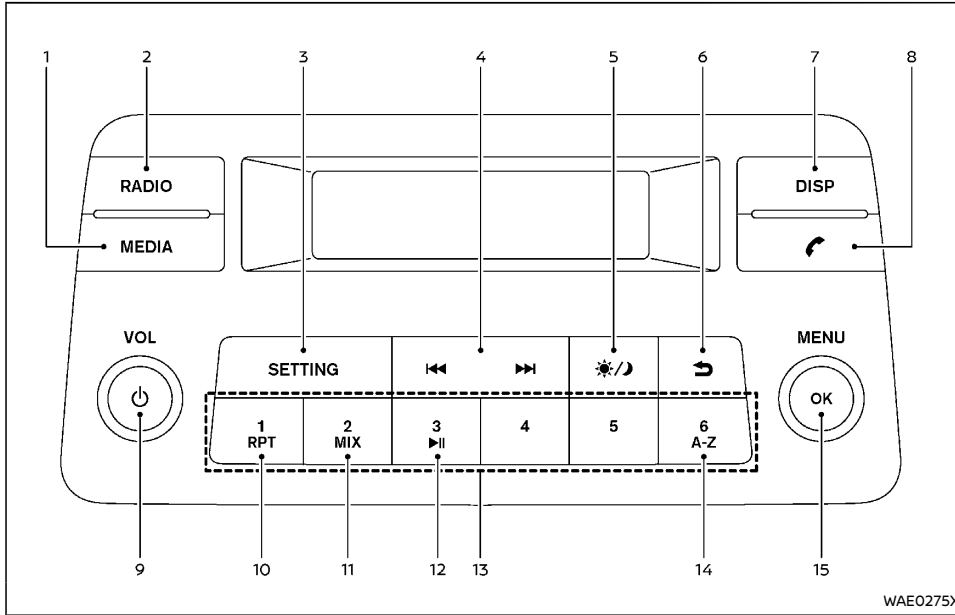

- |                          |                            |
|--------------------------|----------------------------|
| 1. MEDIA button          | 9. Power/VOL (volume) dial |
| 2. RADIO button          | 10. RPT (repeat) button    |
| 3. SETTING button        | 11. MIX button             |
| 4. Seek/track button     | 12. Pause button           |
| 5. Day/Night button      | 13. Station memory buttons |
| 6. Back button           | 14. A-Z button             |
| 7. DISP (display) button | 15. OK/MENU dial           |
| 8. Phone button          |                            |

## Audio main operation

The audio system operates when the ignition switch is placed in the "ON" or "ACC" position.

### **Power/VOL dial:**

#### **Power ON/OFF:**

To turn on the audio system, push the Power/VOL dial.

The system will turn on in the mode, which was used immediately before the system was turned off.

To turn off the audio system, push the Power/VOL dial.

#### **Volume control:**

To control the volume, turn the Power/VOL dial.

Turn the Power/VOL dial clockwise to make the sound louder.

Turn the Power/VOL dial counterclockwise to make the sound quieter.

#### **OK/MENU dial:**

Push the OK/MENU dial to display the current audio source list or the FM list.

Turn the OK/MENU dial to select displaying menu.

#### **Back button:**

Push the Back button to return to the previous screen.

#### **SETTING button:**

To configure "Radio", "Audio", "Clock", "Language" or "BT" settings, perform the following procedure:

1. Push the SETTING button.
2. Turn the OK/MENU dial clockwise or counterclockwise, the display will appear in the following order:

Radio ⇄ Audio ⇄ Clock ⇄ Language ⇄ BT

3. Push the OK/MENU dial.

#### **Radio setting:**

Turn the OK/MENU dial to select "Radio" and push the OK/MENU dial.

"Ref. FM List" is displayed. Push the OK/MENU dial to update the FM station list.

#### **Audio setting:**

Turn the OK/MENU dial to select "Audio" and push the OK/MENU dial.

Turn the OK/MENU dial to select the preferred audio setting item and then push the OK/MENU dial.

Turn the OK/MENU dial clockwise or counter-clockwise to select the following items and push the OK/MENU dial to confirm.

The items that can be set for "Audio" are shown below:

- **Sound**

Bass:

Use this control to enhance or attenuate bass response sound.

Treble:

Use this control to enhance or attenuate the treble.

Balance:

Use this control to adjust the balance of the volume between the left and the right speakers.

Fade:

Use this control to adjust the balance of the volume between the front and the rear speakers.

- **AUX In**

Use this control to adjust the volume output from the auxiliary source.

- **Speed Vol. (Volume)**

This mode controls the volume output from the speakers automatically in relation to vehicle speed.

Adjusting the setting to "Off" turns off the speed volume feature.

- **Bass Boost**

Turn on or off the Bass Boost feature which emphasizes the lower audio frequencies.

- **Audio Default**

The audio unit has a saved preset settings as a factory default. Select "Yes" to change all settings back to the factory preset settings. Select "No" to exit the menu keeping the current settings.

#### **Clock setting:**

Turn the OK/MENU dial to select "Clock" and push the OK/MENU dial.

Turn the OK/MENU dial to select the preferred clock setting item and then push the OK/MENU dial.

The items that can be set for "Clock" are shown below:

- **Set Time**

Select "Set Time" then adjust the clock as follows:

The hour display will start flashing. Turn the OK/MENU dial to adjust the hour and push the OK/MENU dial. The minute display will start flashing. Turn the OK/MENU dial to adjust the minute and push the OK/MENU dial to finish the clock adjustment.

- **On/Off**

The clock display can be turned on and off. When "On" is selected, the clock will be displayed. (The clock will keep being displayed even after the power of the audio unit is turned off). When "Off" is selected, the

clock will not be displayed.

- **Format**

Switch the clock display between 24-hour mode and 12-hour clock mode.

#### **Language setting:**

Turn the OK/MENU dial to select "Language" and push the OK/MENU dial.

Select the appropriate language and push the OK/MENU dial. Upon completion, the screen will automatically adapt the language setting.

#### **Bluetooth® setting:**

Turn the OK/MENU dial to select "BT" and push the OK/MENU dial. For details on the Bluetooth® setting, see "Bluetooth® settings" (P.4-35).



#### **Phone button:**

For details on how to use the Phone button, see "Bluetooth® Hands-Free Phone System" (P.4-33).



#### **Day/Night button:**

Push the Day/Night button to switch the display brightness between the daytime and nighttime modes.

#### **MEDIA button:**

Push the MEDIA button to play a compatible device when it is connected.

Each time the MEDIA button is pushed, the audio source will change.

The sources that are not available will be skipped except for AUX mode.

## Radio operation

The audio system operates when the ignition switch is placed in the "ON" or "ACC" position.

### RADIO button:

To change the radio bands, push the RADIO button until the desired band appears.

FM 1 → FM 2 → AM → FM 1

When the RADIO button is pushed for more than 1.5 seconds, the FM station list is updated.

### OK/MENU dial:

To tune to stations manually, turn the OK/MENU dial until the preferred station is selected.

While the FM mode is selected, push the OK/MENU dial to display the FM list. To select a station from the list, turn the OK/MENU dial then push OK/MENU dial.



### Seek/track buttons:

Push the ◀◀ or ▶▶ button to seek available station.

When pushing and holding the ◀◀ or ▶▶ button, seek tuning will skip the available stations until the button is released.

### 1 2 3 4 5 6 Station memory buttons:

During radio reception, pushing the station memory button for less than 1.5 seconds will select the stored radio station.

The audio system can store up to 12 FM station frequencies (6 in each of FM 1 and FM 2 ) and 6 AM station frequencies.

1. Tune to the desired broadcasting station frequency.
2. Push and hold a station memory button 1 - 6 until a beep sounds.

3. The indicator will be displayed indicating that the memory is stored properly.
4. Perform steps 1 - 3 for all other memory buttons.

If the battery cable is disconnected, or if the audio fuse blows, the station memory will be erased. If this occurs, reset the desired stations.

### USB (Universal Serial Bus) Connection Port

Refer to your device manufacturer's owner information regarding the proper use and care of the device.

### USB memory device main operation:

The USB connection port is located on the lower part of the instrument panel. See "USB (Universal Serial Bus) connection port/AUX (auxiliary) input jack" (P.4-31). Connect a USB memory device into the port. The USB memory device will be activated automatically.

If the system was turned off while the USB memory device was playing, pushing the Power/VOL dial will start the USB memory device.

### MEDIA button:

If another audio source is playing and a USB memory device is inserted, push the MEDIA button repeatedly until the display changes to the USB mode.

### DISP button:

While a track with recorded music information tags (ID3-tags) is being played, the title of the played track is displayed by pushing the DISP button.

When the DISP button is pushed repeatedly, further information about the track can be displayed along with the track name as follows:

- Track time
- Artist
- Album

Track details:

Pushing and holding the DISP button will turn the display into a detailed overview. Push the Back button to return to the display for the main display mode.



### Seek/track buttons:

Pushing the ◀◀ / ▶▶ button once, the track will skip forward to the next track or backward to the beginning of the current track. Push the ◀◀ / ▶▶ button more than once to skip through the tracks.

Push and hold the ◀◀ / ▶▶ button to fast-forward or rewind through the track. When the button is released, the track will play at normal playing speed.

### List view:

While the track is being played, push the OK/MENU dial to display the available tracks in a listed view mode. To select a track from the list, or a track to start listening to, turn the OK/MENU dial then push OK/MENU dial.

### Folder browsing:

If the recorded media contains folders with music files, select a track from a folder in the following procedures:

1. Push the OK/MENU dial to display the list view mode.
2. Push the Back button to display the folder list.
3. Turn the OK/MENU dial to select the preferred folder.



4. Push the OK/MENU dial to access the folder. Push the OK/MENU dial again to start playing the first track or turn the OK/MENU dial, and push the OK/MENU dial to select another track.

If the current selected folder contains sub folders, push the OK/MENU dial. A new screen with a list of sub folders will be displayed. Turn the OK/MENU dial to go to the sub folder then push the OK/MENU dial to select it.

To return to the previous folder screen, push the Back button.

#### **Quick search:**

In the list view mode, a quick search can be performed to find a track from the list. Push the A-Z button, turn the OK/MENU dial to the first alphabetic letter of the song title and then push the OK/MENU dial. When found, a list of the available songs will be displayed. Select, and push the OK/MENU dial to play the preferred track.

#### **RPT button:**

Push the RPT button repeatedly to change the play mode as follows:



(Normal) → RPT (Repeat) → (Normal)

#### **MIX button:**

Push the MIX button repeatedly to change the play mode as follows:

(Normal) → MIX → (Normal)

#### **Pause button:**

Push the  button to pause the track. Push the  button again to play the track.

## iPod player operation

### **Compatibility:**

The system unit is compatible with all devices (past and future) supporting Apple Accessory Protocol on USB link.

It includes (and not limited to):

- iPod classic
- iPod nano (6th and 7th generations)
- iPod touch (4th, 5th and 6th generations)
- iPhone 3G, iPhone 4, iPhone 5, iPhone 5c, iPhone 5s, iPhone 6, iPhone 6 Plus, iPhone 6s, iPhone 7, iPhone 7 Plus, iPhone 8, iPhone 8 Plus, iPhone X, iPhone XR, iPhone XS, iPhone XS Max

The devices listed above may not function depending on the software and firmware versions.

### **Connecting iPod:**

The USB connection port is located on the lower part of the instrument panel. See "USB (Universal Serial Bus) connection port/AUX (auxiliary) input jack" (P.4-31).

Connect an iPod into the port. The iPod will be played automatically.

When the iPod is connected to the vehicle, the iPod music library can only be operated by the vehicle audio controls.

### **MEDIA button:**

If another audio source is playing and an iPod is connected, push the MEDIA button repeatedly until the display changes to the iPod mode.

### **DISP button:**

While a track with recorded music information tags (ID3-tags) is being played, the title of the played track is displayed by pushing the DISP button.

When the DISP button is pushed repeatedly, further information about the track can be displayed along with the track name as follows:



- Track time
- Artist
- Album

Track details:

Pushing and holding the DISP button will turn the display into a detailed overview. To return to the main display, push the Back button.



### **Seek/track buttons:**

When the  button is pushed once, the track will skip forward to the next track or backward to the beginning of the current track. Push the  button more than once to skip through the tracks.

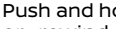
Push and hold  button to fast-forward or rewind the track. When the button is released, the iPod will return to normal play speed.

### **Quick search:**

When the list screen is shown on the display, a quick search can be performed to find a track from the list. Push the A-Z button, turn the OK/MENU dial to the first alphabetic letter of the song title and then push the OK/MENU dial. When found, a list of the available songs will be displayed. Select, and push the OK/MENU dial to play the preferred track.

### RPT button:

Push the RPT button repeatedly to change the play mode as follows:

(Normal) → RPT (Repeat) → (Normal)

### MIX button:

Push the MIX button repeatedly to change the play mode as follows:

(Normal) → MIX → (Normal)

### ▶|| Pause button:

Push the ▶|| button to pause the track. Push the ▶|| button again to play the track.

### Bluetooth® audio player operation

If you have a compatible Bluetooth® audio device that is capable of playing audio files, the device can be connected to the vehicle's audio system so that the audio files on the device play through the vehicle's speakers.

#### NOTE:

- **When a Bluetooth® audio device is connected to the system, audio function can only be controlled through the device.**
- **For additional information regarding Bluetooth® audio, refer to the device owner's manual.**

### Connecting Bluetooth® audio:

To connect your Bluetooth® audio device to the vehicle, see "Connecting a device" (P.4-34).

### MEDIA button:

If another audio source is playing and a Bluetooth® audio device is connected, push the MEDIA button repeatedly until the display changes to the Bluetooth® audio mode.



### Seek/track buttons:

When the ◀◀ / ▶▶ button is pushed, the track will skip forward to the next track or backward to the previous track.

### OK/MENU dial:

Turn the OK/MENU dial to skip to the next or the previous track.

### ▶|| Pause button:

Push the ▶|| button to pause the track. Push the ▶|| button again to play the track.

### Auxiliary (AUX) device player operation

The AUX input jack is located on the lower part of the instrument panel. (See "USB (Universal Serial Bus) connection port/AUX (auxiliary) input jack" (P.4-31).) The AUX input jack accepts any standard analog audio input such as from a portable cassette tape/CD player, MP3 player or laptop computer.

NISSAN strongly recommends using a stereo mini plug cable when connecting your music device to the audio system. Music may not play properly when a monaural cable is used.

### MEDIA button:

To switch to the AUX mode, push the MEDIA button repeatedly until the AUX mode is selected.

## STEERING WHEEL MOUNTED CONTROLS (if equipped)

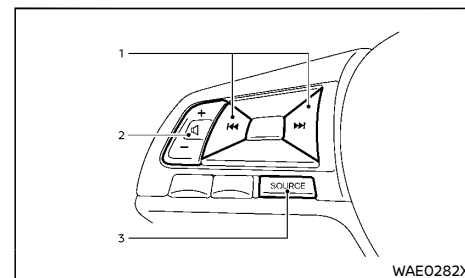

1. Seek/Track buttons
2. Volume control button
3. Source select button

### Seek/Track buttons

Push the ◀◀ / ▶▶ buttons to select a station or track.

Depending on the status of the vehicle information display, etc., the ◀◀ / ▶▶ buttons cannot be used for audio control.

#### ● RADIO

- Pushing ◀◀ / ▶▶ shorter  
Next or previous station

#### ● iPod or USB device

- Pushing ◀◀ / ▶▶ shorter  
Next track or the beginning of the current track (the previous track if the button is pushed immediately after the current track starts playing)
- Pushing ◀◀ / ▶▶ longer  
Fast-forward or rewind

- **Bluetooth® audio**

- Pushing ◀◀ / ▶▶ shorter

Next track or the beginning of the current track (the previous track if the button is pushed immediately after the current track starts playing)

### Volume control button

Push the + or - side of the button to increase or decrease the volume.

### Source select button

Push the source select button to change the mode to available audio source.

### USB (Universal Serial Bus) CONNECTION PORT/AUX (auxiliary) INPUT JACK

The USB connection port and AUX input jack are located on the lower part of the instrument panel.

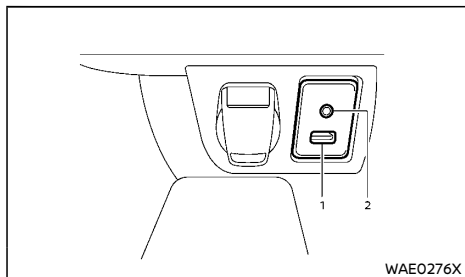

Right-Hand Drive (RHD) model

1. USB connection port
2. AUX input jack

### USB connection port:

Insert USB devices or iPod connectors into this port.

Refer to your device manufacturer's owner

information regarding the proper use and care of the devices to be connected.



### WARNING:

**Do not connect, disconnect or operate the USB device while driving. Doing so can be a distraction. If distracted you could lose control of your vehicle and cause an accident or serious injury.**



### CAUTION:

- **Do not force the USB device into the USB connection port. Depending on the USB port type, inserting the USB device tilted or upside down into the port may damage the port. Make sure that the USB device is connected correctly into the USB connection port.**
- **Do not grab the USB connection port cover (if equipped) when pulling the USB device out of the port. This could damage the port and the cover.**
- **Do not leave the USB cable in a place where it can be pulled unintentionally. Pulling the cable while it is connected may damage the port.**
- **The USB connection port can provide 1 A charging circuit for your phone device. If the charging circuit of your device is more than 1 A, it is recommended to charge your device by power outlet converter, or your device will lose power quickly sometimes.**

### AUX input jack:

Compatible audio devices, such as some MP3 players, can be connected to the system through the AUX input jack.



### WARNING:

**Do not allow the cable or an external device connected to the AUX terminal to affect your driving.**

### NOTE:

- **Depending on the external device, please note that the volume may be louder or quieter than that of the external device.**
- **When the AUX contacts the plug of the connector cable, noise may be heard.**
- **The connected external device cannot be operated with the main audio system. The volume and sound quality can be adjusted.**
- **The song title in the external device cannot be displayed on the audio display.**
- **For the power source of the external device, use the special battery. The external device cannot be charged with the AUX terminal. Noise may be heard if the radio etc. is operated while charging the battery with the power outlet of the vehicle.**

### USB MEMORY DEVICE CARE

- **Do not touch the terminal portion of the USB memory device.**
- **Do not place heavy objects on the USB memory device.**
- **Do not store the USB memory device in highly humid locations.**
- **Do not expose the USB memory device to direct sunlight.**
- **Do not spill any liquids on the USB memory device.**

Refer to the USB memory device Owner's Manual for details.

## ANTENNA

### WINDOW ANTENNA (if equipped)

The antenna pattern is printed inside the rear window.



#### CAUTION:

- Do not place metallic film near the rear window. Do not attach any metal items to the rear window. This may cause poor reception and/or noise.
- When cleaning the inside of the rear window, be careful not to scratch or damage the rear window antenna. Lightly wipe along the antenna with a dampened soft cloth.

### ROD ANTENNA (if equipped)

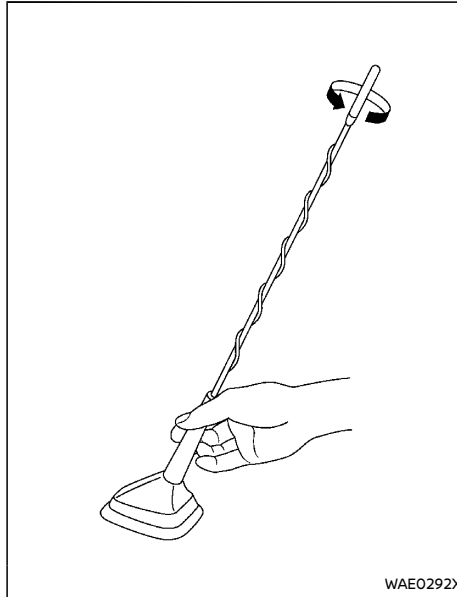

The antenna can be removed if necessary.

Hold the bottom of the antenna and remove by turning counterclockwise.

To install the antenna, turn the antenna clockwise and tighten.



#### CAUTION:

To avoid damaging or deforming the antenna, be sure to remove the antenna under the following conditions.

- The vehicle enters an automatic car wash.
- The vehicle enters a garage with a low ceiling.
- The vehicle is covered with a car cover.

## CAR PHONE OR CB RADIO

When installing a CB, ham radio or a car phone in your vehicle, be sure to observe the following cautions, otherwise the new equipment may adversely affect the Engine Control System and other electronic parts.

### CAUTION:

- Keep the antenna as far away as possible from the Electronic Control Module.
- Keep the antenna wire at least 20 cm (8 in) away from the Engine Control harnesses. Do not route the antenna wire next to any harnesses.
- Adjust the antenna standing wave ratio as recommended by the manufacturer.
- Connect the ground wire from the radio chassis to the body.
- For details, consult a NISSAN dealer.

## Bluetooth® HANDS-FREE PHONE SYSTEM (if equipped)

For models with NissanConnect System, see the separate NissanConnect Owner's Manual.

### WARNING:

- Use a phone after stopping your vehicle in a safe location. If you have to use a phone while driving, exercise extreme caution at all times so full attention may be given to vehicle operation.
- If you are unable to devote full attention to vehicle operation while talking on the phone, pull off the road to a safe location and stop your vehicle.

### CAUTION:

To avoid discharging the vehicle battery, use a phone after starting the engine.

If you have a compatible Bluetooth® enabled cellular phone, you can set up a wireless connection between your cellular phone and the in-vehicle phone module. With Bluetooth® wireless technology, you can make or receive a hands-free telephone call with your cellular phone in the vehicle.

## REGULATORY INFORMATION

### Bluetooth® trademark





Bluetooth® is a trademark owned by Bluetooth SIG, Inc. and licensed to Shenzhen Hangsheng Electronics Co., Ltd.

### USING THE SYSTEM

To get the best performance out of the system, keep the interior of the vehicle as quiet as possible. Keep vents pointed away from the microphone and close the windows to eliminate surrounding noises (traffic noises, vibration sounds, etc.).

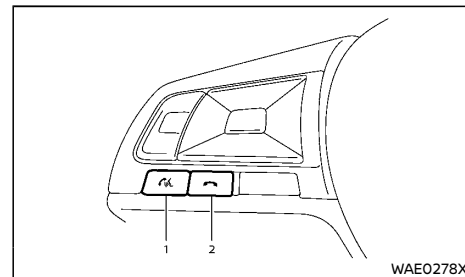
### Control buttons and microphone Steering wheel mounted control (if equipped):



1. Phone send  button
2. Phone end  button

### Control panel buttons:

The control panel is located at the center of the instrument panel.

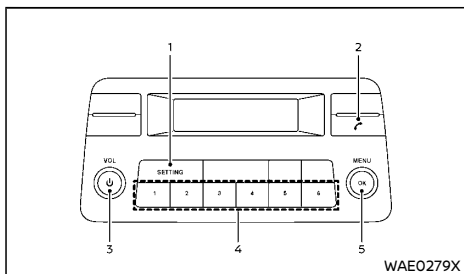

1. SETTING button
2. Phone  button
3. Power/VOL (Volume) dial
4. Station memory buttons
5. OK/MENU dial



#### Microphone:

Microphone is located near the map light.

### GETTING STARTED

The following procedures will help you get started using the Bluetooth® Hands-Free Phone System.

#### Initialization

When the ignition switch is placed in the "ON" position, the system is initialized, which takes a few seconds. If the phone  button is pushed before the initialization completes, the system may not respond. Wait a few seconds and push the phone  button again to start operating the Bluetooth® Hands-Free Phone System operation.

### Turning Bluetooth® on

1. Push the SETTING button and select "BT" from the setting menu using the OK/MENU dial.
2. Select "ON/OFF" using the OK/MENU dial to turn on the Bluetooth® setting.

### Connecting a device



#### NOTE:

**To avoid accidents, it is advised that you conduct the connection operation when the vehicle is stationary.**

1. Push the SETTING button and select "BT" from the setting menu using the OK/MENU dial.
2. Select "Connection info" using the OK/MENU dial to display the connection information.
3. Enter the PIN number on the display into the device to be connected.

A notification message will be displayed when the phone is successfully paired.

While the Bluetooth® connection is active, the following icons will appear on the display.

- : Signal strength indicator
  - : Battery status indicator\*
  - : Bluetooth® connection ON indicator
- \*: If low battery is indicated, the Bluetooth® device must be recharged soon.

#### NOTE:

- **Some Bluetooth® enabled cellular phones may not be recognized by the in-vehicle phone module.**
- **Necessary steps and prompts may vary depending on the device and the conditions. Some phones may not require a**

#### PIN number in order to connect.

- **Upon turning the vehicle power on, the Bluetooth® Hands-Free Phone System will automatically search for previously connected devices in range if the Bluetooth® setting is on.**



### Registering phone numbers

You can register up to 6 commonly used phone numbers. To register a phone number, push and hold one of the station memory buttons while the call is in progress. The registered numbers can be confirmed from "Common phone" in the Bluetooth® setting menu. See "Bluetooth® settings" (P.4-35).



### USING THE SYSTEM



#### Making a call

There are two ways to make a call with this system.



- **Calling registered phone number:**  
Up to six phone numbers can be registered and used to make calls.
  - 1) Push the phone  button to activate the hands-free phone mode.
  - 2) Push one of the six station memory buttons briefly to make a call to the phone number registered to the button.
- **Redialing:**  
To make a call to the last phone number this system used, push the phone  button twice or push and hold the phone send  button (if equipped).

## Receiving a call



To answer an incoming call, push the phone  button or the phone send  button (if equipped).

To reject an incoming call, push and hold the phone  button or push the phone end  button (if equipped).

## During a call

The user may switch the call from the hands-free mode to the handset mode by pushing the phone  button during a call. Push the phone  button again to switch back to the hands-free mode.

## Ending a call

The user may end a call by pushing and holding the phone  button or pushing the phone end  button (if equipped).

## VOLUME CONTROL

Turning the Power/VOL dial during a call will control the phone call volume.

## Bluetooth® SETTINGS

Bluetooth® related setting menus can be accessed with the following procedure.

1. Push the SETTING button.
2. Turn the OK/MENU dial to select "BT" and push the OK/MENU dial.

Available items:

- "ON/OFF"  
Turns the Bluetooth® on or off.
- "Connection info"  
Sets up Bluetooth® connection.
- "Volume"  
Sets the phone volume.

- "Delete all devices"  
Deletes all devices from the registration.
- "Common phone"  
Displays registered phone numbers. The registered phone numbers can be used to make a call. See "Registering phone numbers" (P.4-34) and "Making a call" (P.4-34).

**MEMO**



# 5 Starting and driving

Break-in schedule .....	5-3	Idling Stop System (if equipped) .....	5-15
Before starting engine .....	5-3	Idling Stop System indicator light (if equipped) ....	5-16
Precautions when starting and driving .....	5-3	Idling Stop System display (if equipped) .....	5-16
Exhaust gas (carbon monoxide) .....	5-4	Idling Stop OFF switch .....	5-17
Three-way catalyst .....	5-4	Vehicle Dynamic Control (VDC) system .....	5-18
Turbocharger system .....	5-4	How to turn off the VDC system .....	5-19
Care when driving .....	5-5	Hill start assist system .....	5-20
Engine cold start period .....	5-5	Blind Spot Warning (BSW) (if equipped) .....	5-20
Loading luggage .....	5-5	BSW system operation .....	5-21
Driving in wet conditions .....	5-5	How to enable/disable the BSW system .....	5-22
Driving in winter conditions .....	5-5	BSW system limitations .....	5-23
Ignition switch (model without Intelligent		BSW driving situations .....	5-23
Key system) .....	5-6	System temporarily unavailable .....	5-25
Continuously Variable Transmission (CVT) .....	5-6	System malfunction .....	5-25
Manual Transmission (MT) .....	5-6	System maintenance .....	5-25
Steering lock .....	5-6	Rear Cross Traffic Alert (RCTA) (if equipped) .....	5-26
Key positions .....	5-6	RCTA system operation .....	5-26
Push-button ignition switch (model with Intelligent		How to enable/disable the RCTA system .....	5-27
Key system) .....	5-7	RCTA system limitations .....	5-28
Precautions on push-button ignition		System temporarily unavailable .....	5-29
switch operation .....	5-7	System malfunction .....	5-29
Intelligent Key system .....	5-7	System maintenance .....	5-30
Steering lock .....	5-8	Intelligent Emergency Braking system (if equipped) ....	5-30
Ignition switch positions .....	5-8	Intelligent Emergency Braking	
Intelligent Key battery discharge .....	5-9	system operation .....	5-31
Starting engine (model without Intelligent		Turning the Intelligent Emergency Braking	
Key system) .....	5-10	system ON/OFF .....	5-32
Starting engine (model with Intelligent Key system) ....	5-10	Intelligent Emergency Braking	
Driving vehicle .....	5-11	system limitations .....	5-33
Driving with Continuously Variable		System temporarily unavailable .....	5-34
Transmission (CVT) .....	5-11	System malfunction .....	5-35
Driving with Manual Transmission (MT) .....	5-14	System maintenance .....	5-35

Fuel Efficiency and Carbon Dioxide Reduction driving tips .....	5-36
Increasing fuel economy and reducing Carbon Dioxide emissions .....	5-36
Parking .....	5-37
Trailer towing .....	5-39
Electric power steering .....	5-39
Brake system .....	5-40
Brake precautions .....	5-40
Brake assist .....	5-40
Anti-lock Braking System (ABS) .....	5-41
Using system .....	5-41

Self-test feature .....	5-41
Normal operation .....	5-41
Vehicle security .....	5-42
Cold weather driving .....	5-42
Battery .....	5-42
Engine coolant .....	5-42
Tire equipment .....	5-42
Special winter equipment .....	5-43
Parking brake .....	5-43
Corrosion protection .....	5-43

## BREAK-IN SCHEDULE

During the first 1,600 km (1,000 miles), follow these recommendations to obtain maximum engine performance and ensure the future reliability and economy of your new vehicle. Failure to follow these recommendations may result in shortened engine life and reduced engine performance.

- Do not drive at a constant speed, either fast or slow, for long periods of time.
- Do not run the engine over 4,000 rpm.
- Do not accelerate at full throttle in any gear.
- Do not start quickly.
- Do not brake hard as much as possible.

## BEFORE STARTING ENGINE



### WARNING:

**The driving characteristics of your vehicle will change remarkably by any additional load and its distribution, as well as by adding optional equipment (trailer coupling, roof racks, etc.). Your driving style and speed must be adjusted according to the circumstances. Especially when carrying heavy loads, your speed must be reduced adequately.**

- Make sure the area around the vehicle is clear.
- Visually inspect tires for their appearance and condition. Measure and check the tire pressure for proper inflation.
- Check that all windows and lights are clean.
- Adjust the seat and head restraint positions.
- Adjust the inside and outside rearview mirror positions.
- Fasten your seat belt and ask all passengers to do the same.
- Check that all doors are closed.
- Check the operation of the warning lights when the ignition switch is placed in the "ON" position.
- Maintenance items in the "8. Maintenance and do-it-yourself" section should be checked periodically.

## PRECAUTIONS WHEN STARTING AND DRIVING



### WARNING:

- **Never leave children or adults who would normally require the support of others alone in your vehicle. Pets should not be left alone either. They could unknowingly activate switches or controls and inadvertently become involved in a serious accident and injure themselves. On hot, sunny days, temperatures in a closed vehicle could quickly become high enough to cause severe or possibly fatal illness to people or animals.**
- **Closely supervise children when they are around your vehicle to prevent them from playing and becoming locked in the trunk where they could be seriously injured. Keep the vehicle locked with the trunk closed when not in use, and prevent children's access to vehicle keys.**

### NOTE:

**During the first few months after purchasing a new vehicle, if you smell strong odors of Volatile Organic Compounds (VOCs) inside the vehicle, ventilate the passenger compartment thoroughly. Open all the windows before entering or while in the vehicle. In addition, when the temperature in the passenger compartment rises, or when the vehicle is parked in direct sunlight for a period of time, turn off the air recirculation mode of the air conditioner and/or open the windows to allow sufficient fresh air into the passenger compartment.**

## EXHAUST GAS (carbon monoxide)



### WARNING:

- Do not breathe exhaust gas; it contains colorless and odorless carbon monoxide. Carbon monoxide is dangerous. It can cause unconsciousness or death.
- If you suspect that exhaust fumes are entering the vehicle, drive with all windows fully open, and have the vehicle inspected immediately.
- Do not run the engine in closed spaces such as a garage.
- Do not park the vehicle with the engine running for an extended period of time.
- Keep the trunk lid closed while driving, otherwise exhaust gas could be drawn into the passenger compartment. If you must drive with the trunk lid open, follow these precautions:
  - Open all the windows.
  - Turn the air recirculation mode off and set the fan speed control to the highest level to circulate the air.
- If electrical wiring or other cable connections must pass to a trailer through the seal of the trunk lid or the body, follow the manufacturer's recommendation to prevent carbon monoxide entry into the vehicle.
- If a special body or other equipment is added for recreational or other usage, follow the manufacturer's recommendation to prevent carbon monoxide entry into the vehicle. (Some recreational vehicle appliances such as stoves, refrigerators, heaters, etc. may also generate carbon monoxide.)

- The exhaust system and body should be inspected by a qualified mechanic whenever:
  - Your vehicle is raised while being serviced.
  - You suspect that exhaust fumes are entering into the passenger compartment.
  - You notice a change in the sound of the exhaust system.
  - You have had an accident involving damage to the exhaust system, underbody, or rear of the vehicle.

## THREE-WAY CATALYST



### WARNING:

- The exhaust gas and the exhaust system are very hot. Keep people, animals and flammable materials away from the exhaust system components.
- Do not stop or park the vehicle over flammable materials such as dry grass, wastepaper or rags. They may ignite and cause a fire.

The three-way catalyst is an emission control device installed in the exhaust system. Exhaust gas in the three-way catalyst is burned at high temperatures to help reduce pollutants.



### CAUTION:

- Do not use leaded gasoline. (See "Recommended fluids/lubricants and capacities" (P.9-2).) Deposits from leaded gasoline seriously reduce the ability of the three-way catalyst to help reduce exhaust pollutants and/or damage the three-way catalyst.

- Keep your engine tuned up. Malfunctions in the ignition, fuel injection, or electrical systems may cause overrich fuel to flow into the three-way catalyst, causing it to overheat. Do not keep driving if the engine misfires, or if noticeable loss of performance or other unusual operating conditions are detected. Have the vehicle inspected promptly by a NISSAN dealer.
- Avoid driving with an extremely low fuel level. Running out of fuel could cause the engine to misfire, damaging the three-way catalyst.
- Do not race the engine while warming it up.
- Do not push or tow your vehicle to start the engine.

## TURBOCHARGER SYSTEM

The turbocharger system uses engine oil for lubrication and cooling of its rotating components. The turbocharger turbine turns at extremely high speeds and it can reach an extremely high temperature. It is essential to maintain a clean supply of oil flowing through the turbocharger system. A sudden interruption of oil supply may cause a malfunction in the turbocharger.

To ensure prolonged life and performance of the turbocharger, it is essential to comply with the following maintenance procedure.



### CAUTION:

- Change the engine oil according to the recommended intervals shown in a separate maintenance booklet.
- Use only the recommended engine oil. See "Recommended fluids/lubricants and capacities" (P.9-2).

## CARE WHEN DRIVING

- **If the engine has been operating at high rpm for an extended period of time, let it idle for a few minutes prior to turn off.**
- **Do not accelerate your engine to high rpm immediately after starting it.**

Driving your vehicle to fit the circumstances is essential for your safety and comfort. As a driver, you should be the one who knows best how to drive in the given circumstances.

### ENGINE COLD START PERIOD

Due to the higher engine speeds, when the engine is cold, extra caution must be exercised when selecting a gear during the engine warm-up period after starting the engine.

### LOADING LUGGAGE

Loads and their distribution and the attachment of equipment (coupling devices, roof baggage carriers, etc.) will considerably change the driving characteristics of the vehicle. Your driving style and speed must be adjusted according to the circumstances.

### DRIVING IN WET CONDITIONS

- Avoid accelerating or stopping suddenly.
- Avoid sharp turning or lane changing suddenly.
- Avoid following too close to the vehicle in front.

When water covers the road surface with water puddles, small water streams, etc., reduce speed to prevent hydroplaning which can cause skidding and loss of control. Worn tires will increase this risk.

### DRIVING IN WINTER CONDITIONS

- Drive cautiously.
- Avoid accelerating or stopping suddenly.
- Avoid sharp turning or lane changing suddenly.
- Avoid sudden steering.
- Avoid following too close to the vehicle in front.

## IGNITION SWITCH (model without Intelligent Key system)



### WARNING:

Never remove the key or turn the ignition switch to the "LOCK" position while driving. The steering wheel will lock and could cause the driver to lose control of the vehicle. This could result in serious vehicle damage or personal injury.

## CONTINUOUSLY VARIABLE TRANSMISSION (CVT)

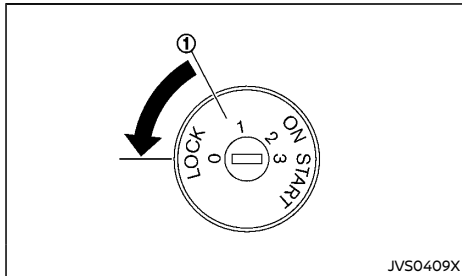

The ignition lock is designed so that the ignition switch cannot be turned to the "LOCK" position until the shift lever is moved to the "P" (Park) position. When moving the ignition switch to the "LOCK" position, to remove the key from the ignition switch, make sure the shift lever is in the "P" (Park) position.

When the ignition switch cannot be turned to the "LOCK" position:

1. Move the shift lever to the "P" (Park) position.
2. Turn the ignition switch slightly in the "ON" direction.

3. Turn the ignition switch to the "LOCK" position.
4. Remove the key.

If the ignition switch is turned to the "LOCK" position, the shift lever cannot be moved from the "P" (Park) position. The shift lever can be moved if the ignition switch is in the "ON" position with the foot brake pedal depressed.

The "OFF" position ① is between the "LOCK" and "ON" positions, although it is not marked on the ignition switch.

## MANUAL TRANSMISSION (MT)

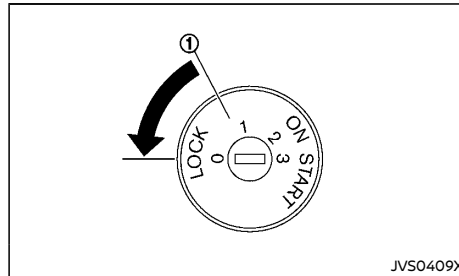

The ignition switch includes a device that helps prevent accidental removal of the key while driving.

The key can only be removed when the ignition switch is in the "LOCK" position.

1. Turn the ignition switch slightly in the "ON" direction.
2. Place the ignition switch in the "LOCK" position.
3. Remove the key.

The "OFF" position ① is between the "LOCK" and "ON" positions, although it is not marked on the

ignition switch.

## STEERING LOCK

To lock steering wheel

1. Turn the ignition switch to the "LOCK" position.
2. Remove the key from the ignition switch.
3. Turn the steering wheel 1/6 of a turn clockwise from the straight up position.

To unlock steering wheel

1. Insert the key into the ignition switch.
2. Gently turn the ignition switch while rotating the steering wheel slightly right and left.

## KEY POSITIONS

### LOCK (OFF)/LOCK (ACC) (0)

- The ignition key can only be removed at this position.
- The steering lock can only be locked at this position.
- The electrical accessory power activates without the engine turned on. (ACC position)

### OFF/OFF (ACC) (1)

- The engine is turned off with the steering wheel unlocked.
- The electrical accessory power activates without the engine turned on. (ACC position)

## PUSH-BUTTON IGNITION SWITCH (model with Intelligent Key system)

### PRECAUTIONS ON PUSH-BUTTON IGNITION SWITCH OPERATION



#### WARNING:

**Do not operate the push-button ignition switch while driving the vehicle except in an emergency. (The engine will stop when the ignition switch is pushed 3 consecutive times or the ignition switch is pushed and held for more than 2 seconds.) The steering wheel will lock and could cause the driver to lose control of the vehicle. This could result in serious vehicle damage or personal injury.**

Before operating the push-button ignition switch, be sure to move the shift lever to the "P" (Park) position (for Continuously Variable Transmission model) or the shift lever to the "N" (Neutral) position (for Manual Transmission model).

### INTELLIGENT KEY SYSTEM

The Intelligent Key system can operate the ignition switch without taking the key out from your pocket or bag. The operating environment and/or conditions may affect the Intelligent Key system operation.



#### CAUTION:

- **Be sure to carry the Intelligent Key with you when operating the vehicle.**
- **Never leave the Intelligent Key inside the vehicle when you leave the vehicle.**
- **If the vehicle battery is discharged, the ignition switch cannot be switched from the "LOCK" position, and if the steering lock is engaged, the steering wheel cannot be moved. Charge the battery as soon as possible (See "Jump starting"**

(P.6-10).)

### Operating range

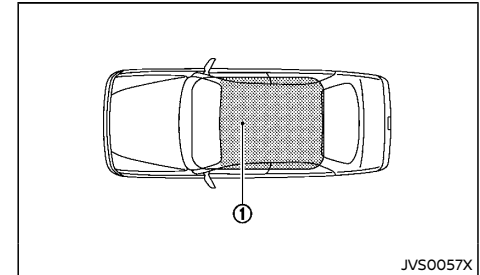

JVS0057X

The Intelligent Key can only be used for starting the engine when the Intelligent Key is within the specified operating range ① as illustrated.

When the Intelligent Key battery is almost discharged or strong radio waves are present near the operating location, the Intelligent Key system's operating range becomes narrower and may not function properly.

If the Intelligent Key is within the operating range, it is possible for anyone, even someone who does not carry the Intelligent Key, to push the ignition switch to start the engine.

- The trunk area is not included in the operating range, but the Intelligent Key may function.
- If the Intelligent Key is placed on the instrument panel, inside the glove box, door pocket, rear parcel shelf or the corner of the interior compartment, the Intelligent Key may not function.
- If the Intelligent Key is placed near the door or window outside the vehicle, the Intelligent Key may function.

### ON (2)

The ignition system and the electrical accessory power activate without the engine turned on.

### START (3)

The engine starter activates and the engine will start. The ignition switch, when released, will automatically turn to the "ON" position.



#### CAUTION:

**As soon as the engine has started, release the ignition switch immediately.**

## Continuously Variable Transmission (CVT) model

The ignition lock is designed so that the ignition switch cannot be switched to the "LOCK" position until the shift lever is moved to the "P" (Park) position. When pushing the ignition switch to the "OFF" position, make sure the shift lever is in the "P" (Park) position.

When the ignition switch cannot be switched to the "LOCK" position:

### Type A:

1. Move the shift lever to the "P" (Park) position.
2. Push the ignition switch to the "OFF" position.
3. Open the door. The ignition switch will change to the "LOCK" position.

If the ignition switch is switched to the "LOCK" position, the shift lever cannot be moved from the "P" (Park) position. The shift lever can be moved if the ignition switch is in the "ON" position with the foot brake depressed.

### Type B:

1. "Shift to Park" warning appears on the vehicle information display and a chime sounds.
2. Move the shift lever to the "P" (Park) position.
3. Open the door. The ignition switch turns to the "LOCK" position.

For warnings and indicators on the vehicle information display, see "Vehicle information display warnings and indicators" (P.2-24).

If the ignition switch is switched to the "LOCK" position, the shift lever cannot be moved from the "P" (Park) position. The shift lever can be

moved if the ignition switch is in the "ON" position with the foot brake pedal depressed.

## STEERING LOCK

The ignition switch is equipped with an anti-theft steering lock device.

### To lock steering wheel

1. Push the ignition switch to the "OFF" position where the ignition switch position indicator will not illuminate.
2. Open or close the door. The ignition switch turns to the "LOCK" position.
3. Turn the steering wheel 1/6 of a turn to the right or left from the straight up position.

### To unlock steering wheel

Push the ignition switch, and the steering wheel will be automatically unlocked.



### CAUTION:

- If the battery of the vehicle is discharged, the push-button ignition switch cannot be switched from the "LOCK" position.
- If the ignition switch position does not change from the "LOCK" position and/or the steering lock release malfunction indicator (if equipped) appears on the vehicle information display, push the ignition switch again while rotating the steering wheel slightly to the right and left.

## IGNITION SWITCH POSITIONS



### WARNING:

Never place the ignition switch in the "OFF" position while driving. The steering wheel may lock and cause the driver to lose control of the vehicle, resulting in serious vehicle damage or personal injury.



### CAUTION:

- Do not leave the vehicle for extended periods of time when the ignition switch is in the "ON" position and the engine is not running. This can discharge the battery.
- Use electrical accessories with the engine running to avoid discharging the vehicle battery. If you must use accessories while the engine is not running, do not use them for extended periods of time and do not use multiple electrical accessories at the same time.

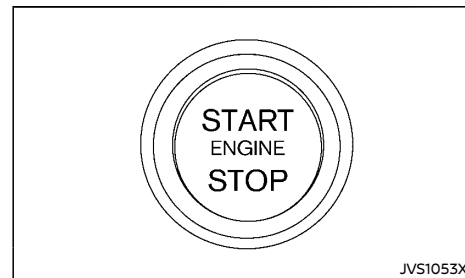

When the ignition switch is pushed without depressing the brake pedal (Continuously Variable Transmission model) or the clutch pedal



(Manual Transmission model), the ignition switch will illuminate.

Push the ignition switch:

- once to change to "ON".
- two times to change to "OFF".

The ignition switch will automatically return to the "LOCK" position when any door is either opened or closed with the ignition switch in the "OFF" position.

### LOCK position

The ignition switch and steering lock can only be locked at this position.

The ignition switch will lock when any door is opened or closed with the ignition switched off.

### ON position

The ignition system and the electrical accessory power activate at this position without the engine turned on.

The "ON" position has a battery saver feature that will place the ignition switch in the "OFF" position, if the vehicle is not running, after some time under the following conditions:

- all doors are closed.
- the engine is stopped.

The battery saver feature will be cancelled if any of the following occur:

- any door is opened.
- ignition switch changes position.

### OFF position

The engine is turned off at this position.

### Auto ACC position

With the vehicle in the "P" (Park) position (CVT model) or "N" (Neutral) position (MT model), the Intelligent Key with you and the ignition switch placed from "ON" to "OFF", the radio can still be used for a period of time, or until the driver's door is opened. After a period of time, functions such as radio and Bluetooth® Hands-Free Phone System may be restarted by turning on the audio system (see "Audio system" (P.4-20) or the separate NissanConnect Owner's Manual) or by pushing the "UNLOCK" button on the Intelligent Key for up to a total of 30 minutes.

### INTELLIGENT KEY BATTERY DISCHARGE

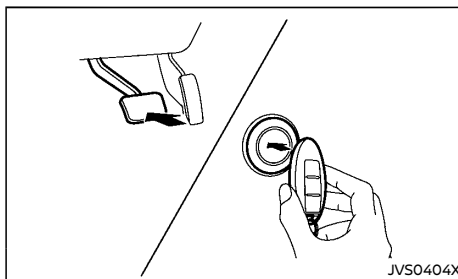

If the battery of the Intelligent Key is discharged, or environmental conditions interfere with the Intelligent Key operation, start the engine according to the following procedure:

#### 1. **Continuously Variable Transmission (CVT) model:**

Move the shift lever to the "P" (Park) or "N" (Neutral) position.

#### **Manual Transmission (MT) model:**

Move the shift lever to the "N" (Neutral) position.

2. Firmly depress the brake pedal.
3. Touch the ignition switch with the Intelligent Key as illustrated. (A chime will sound.)
4. Push the ignition switch while depressing the brake pedal (CVT model) or the clutch pedal (MT model) within 10 seconds after the chime sounds. The engine will start.

After step 3 is performed, when the ignition switch is pushed without depressing the brake pedal (CVT model) or the clutch pedal (MT model), the ignition switch position will change to "ON".

#### **NOTE:**

- **When the ignition switch is placed in the "ON" position or the engine is started by the above procedures, the "Key Battery Low" warning appears on the vehicle information display or the Intelligent Key system warning light may blink in yellow in the meter even if the Intelligent Key is inside the vehicle. This is not a malfunction. To turn off the warning (light), touch the ignition switch with the Intelligent Key again.**
- **If the "Key Battery Low" warning appears on the vehicle information display or the Intelligent Key system warning light in the meter is blinking in green, replace the battery as soon as possible. (See "Intelligent Key battery" (P.8-16).)**

## STARTING ENGINE (model without Intelligent Key system)

1. Apply the parking brake.
2. Depress the foot brake pedal.
3. **Continuously Variable Transmission (CVT) model:**

Move the shift lever to the "P" (Park) or "N" (Neutral) position.

**The starter is designed to operate only when the shift lever is in the proper position.**

### Manual Transmission (MT) model:

Move the shift lever to the "N" (Neutral) position, and depress the clutch pedal to the floor while starting the engine.

**The starter is designed to not operate unless the clutch pedal is fully depressed.**

4. Crank the engine with your foot off the accelerator pedal by turning the ignition switch to the "START" position.
5. Immediately release the ignition switch when the engine starts. If the engine starts, but fails to run, repeat the above procedures.
  - If the engine is very hard to start in extremely cold weather or when restarting, depress the accelerator pedal a little (approximately 1/3 to the floor), hold it and then crank the engine. Release the accelerator pedal when the engine starts.
  - If the engine is very hard to start because it is flooded, depress the accelerator pedal all the way to the floor and hold it. Crank the engine for 5 - 6 seconds. After cranking the engine, release the accelerator pedal. Crank the engine **with your foot off the accelerator pedal** by turning the ignition switch to START. Release the ignition switch

when the engine starts. If the engine starts, but fails to run, repeat the above procedure.



### CAUTION:

- **Do not operate the starter for more than 15 seconds at a time. If the engine does not start, turn the ignition switch off and wait 10 seconds before cranking the engine again. Otherwise, the starter could be damaged.**
  - **If it becomes necessary to start the engine with a booster battery and jumper cables, the instructions and cautions contained in the "6. In case of emergency" section should be carefully followed.**
6. Allow the engine to idle for at least 30 seconds after starting the engine to warm-up. Drive at moderate speeds for a short distance first, especially in cold weather.



### CAUTION:

**Do not leave the vehicle unattended while the engine is warming up.**

## STARTING ENGINE (model with Intelligent Key system)

1. Apply the parking brake.
2. **Continuously Variable Transmission (CVT) model:**

Move the shift lever to the "P" (Park) or "N" (Neutral) position.

**The starter is designed to operate only when the shift lever is in the proper position.**

### Manual Transmission (MT) model:

Move the shift lever to the "N" (Neutral) position.

**The starter is designed to not operate unless the clutch pedal is fully depressed.**

**The Intelligent Key must be carried when operating the ignition switch.**

3. Push the ignition switch to the "ON" position. Firmly depress the brake pedal (CVT model) or the clutch pedal (MT model) and push the ignition switch to start the engine. To start the engine immediately, push and release the ignition switch while depressing the brake pedal (CVT model) or the clutch pedal (MT model) with the ignition switch in any position.
4. If the engine starts, but fails to run, repeat the above procedures.
  - If the engine is very hard to start in extremely cold weather or when restarting, depress the accelerator pedal a little (approximately 1/3 to the floor), hold it and then crank the engine. Release the accelerator pedal when the engine starts.
  - If the engine is very hard to start because it is flooded, depress the accelerator pedal all the way to the floor and hold it. Push the ignition switch to the "ON" position to start cranking the en-

gine. After 5 or 6 seconds, stop cranking by pushing the ignition switch to "OFF". After cranking the engine, release the accelerator pedal. Crank the engine **with your foot off the accelerator pedal** by depressing the brake pedal and pushing the push-button ignition switch to start the engine. If the engine starts, but fails to run, repeat the above procedure.

 **CAUTION:**

- As soon as the engine has started, release the ignition switch immediately.
  - Do not operate the starter for more than 15 seconds at a time. If the engine does not start, push the ignition switch to the "OFF" position and wait 10 seconds before cranking the engine again. Otherwise, the starter could be damaged.
  - If it becomes necessary to start the engine with a booster battery and jumper cables, the instructions and cautions contained in the "6. In case of emergency" section should be carefully followed.
5. Allow the engine to idle for at least 30 seconds after starting the engine to warm-up. Drive at moderate speeds for a short distance first, especially in cold weather.

 **CAUTION:**

- Do not leave the vehicle unattended while the engine is warming up.**
6. To stop the engine, move the shift lever to the "P" (Park) position (CVT model) or "N" (Neutral) position (MT model), apply the parking brake and push the ignition switch to the "OFF" position.

## DRIVING VEHICLE

### DRIVING WITH CONTINUOUSLY VARIABLE TRANSMISSION (CVT)

The Continuously Variable Transmission (CVT) in your vehicle is electronically controlled to produce maximum power and smooth operation.

The recommended operating procedures for this transmission are shown on the following pages. Follow these procedures for maximum vehicle performance and driving enjoyment.

 **WARNING:**

**Do not downshift abruptly on slippery roads. This may cause a loss of control.**

 **CAUTION:**

- The cold engine idle speed is high, so use caution when shifting the transmission into a forward or reverse position before the engine has warmed up.
- Avoid revving up the engine while the vehicle is stopped. This could cause unexpected vehicle movement.
- Never shift to either the "P" (Park) or "R" (Reverse) position while the vehicle is moving forward and "P" (Park) or "D" (Drive) position while the vehicle is reversing. This could cause an accident and damage the transmission.
- Except in an emergency, do not shift to the "N" (Neutral) position while driving. Coasting with the transmission in the "N" (Neutral) position may cause serious damage to the transmission.
- Start the engine in either the "P" (Park) or "N" (Neutral) position. The engine will not start in any other position. If it does, have

your vehicle checked by a NISSAN dealer.

- Shift into the "P" (Park) position and apply the parking brake when at a standstill for longer than a short waiting period.
- Keep the engine at idling speed while shifting from the "N" (Neutral) position to any driving position.
- When stopping the vehicle on an uphill grade, do not hold the vehicle by depressing the accelerator pedal. The foot brake pedal should be depressed in this situation.

### Starting vehicle

1. After starting the engine, fully depress the foot brake pedal before moving the shift lever out of the "P" (Park) position.
2. Keep the foot brake pedal depressed and move the shift lever to a driving position.
3. Release the parking brake, the foot brake pedal, and then gradually start the vehicle in motion.

The CVT is designed so the foot brake pedal **MUST** be depressed before shifting from the "P" (Park) position to any driving position while the ignition switch is in the "ON" position.

The shift lever cannot be moved out of the "P" (Park) position and into any of the other positions if the ignition switch is placed in the "LOCK" or "OFF" position or if the key is removed.

 **CAUTION:**

- **DEPRESS THE FOOT BRAKE PEDAL** - Shifting the shift lever to "D", "R" or "L" without depressing the foot brake pedal causes the vehicle to move slowly when the

engine is running. Make sure the foot brake pedal is depressed fully and the vehicle is stopped before shifting the shift lever.

- **MAKE SURE OF THE SHIFT LEVER POSITION** - Make sure the shift lever is in the desired position. "D" and "L" are used to move forward and "R" to back up.
- **WARM UP THE ENGINE** - Due to the higher idle speeds when the engine is cold, extra caution must be exercised when shifting the shift lever into the driving position immediately after starting the engine.

### Shifting

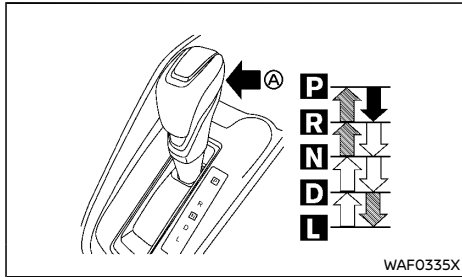

Right-Hand Drive (RHD) model

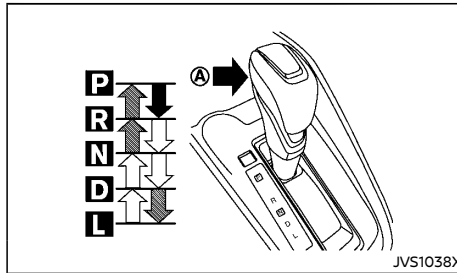

Left-Hand Drive (LHD) model

- ➔: Push the button (A) while depressing the foot brake pedal.
- ➔: Push the button (A).
- ↔: Just move the shift lever.



### WARNING:

- **Apply the parking brake if the shift lever is in any position while the engine is not running. Failure to do so could cause the vehicle to move unexpectedly or roll away and result in serious personal injury or property damage.**
- **If the shift lever cannot be moved from the "P" (Park) position while the engine is running and the foot brake pedal is depressed, the stop lights may not work. Malfunctioning stop lights could cause an accident injuring yourself and others.**

After starting the engine, fully depress the foot brake pedal, push the shift lever button and move the shift lever out of the "P" (Park) position.

If the ignition switch is placed in the "OFF" position for any reason while the shift lever is in

any positions other than the "P" (Park) position, the ignition switch cannot be placed in the "LOCK" position.

When it is hard to shift the shift lever from the "P" (Park) position to other position, first check that the parking brake is applied, then release the foot brake pedal and depress the foot brake pedal again.

If the ignition switch cannot be placed in the "LOCK" position, perform the following steps:

1. Apply the parking brake.
2. Place the ignition switch in the "ON" position while depressing the foot brake pedal.
3. Move the shift lever to the "P" (Park) position.
4. **Models with Intelligent Key system:**  
Place the ignition switch in the "OFF" position.

### Models without Intelligent Key system:

Place the ignition switch in the "LOCK" position.

### P (Park):

Use this position when the vehicle is parked or when starting the engine. **Make sure that the vehicle is completely stopped and move the shift lever into the "P" (Park) position.** Apply the parking brake. When parking on a hill, first depress the foot brake pedal, apply the parking brake, and then move the shift lever into the "P" (Park) position.

### R (Reverse):

Use this position to back up. Make sure that the vehicle is completely stopped before selecting the "R" (Reverse) position.

### **N (Neutral):**

Neither the forward nor reverse gear is engaged. The engine can be started in this position. You may shift to the "N" (Neutral) position and restart a stalled engine while the vehicle is moving.

### **D (Drive):**

Use this position for all normal forward driving.

### **L (Low):**

Use this position when climbing steep hills slowly or driving slowly through deep snow, sand or mud, or for maximum engine braking on steep downhill grades.

### **SPORT mode switch**

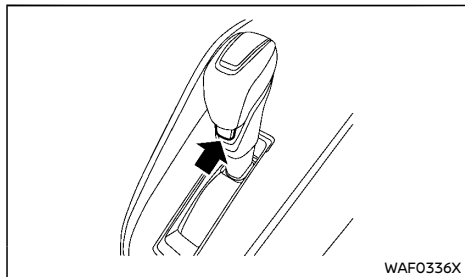

To select the SPORT mode, push the SPORT mode switch with the shift lever in the "D" (Drive) position. The SPORT mode indicator light **SPORT** in the meter panel illuminates. To turn off the SPORT mode, push the SPORT mode switch again. The SPORT mode indicator light will turn off. When the shift lever is shifted to any position other than "D", the SPORT mode will be automatically turned off.

### **"OFF" position:**

For normal driving and fuel economy, use the "OFF" position.

### **"ON" position:**

For driving up or down long slopes where engine braking is necessary, or for powerful acceleration, use the "ON" position. The transmission will automatically select a different gear ratio, allowing the engine to provide high output.

When driving conditions change, push the switch to turn the SPORT mode off.

Remember not to drive at high speeds for extended periods of time with the SPORT mode in the "ON" position. This reduces fuel economy.

### **Accelerator downshift - in D (Drive) position -**

For passing or climbing hills, depress the accelerator pedal to the floor. This shifts the transmission down into a lower gear, depending on the vehicle speed.

### **Shift lock release**

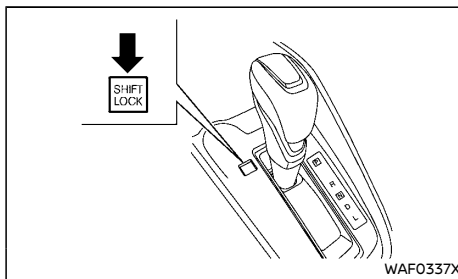

### **Right-Hand Drive (RHD) model**

If the battery charge is low or discharged, the shift lever may not be moved from the "P" (Park) position even with the brake pedal depressed

and the shift lever button pushed.

To move the shift lever, perform the following procedure:

#### **1. Models with Intelligent Key system:**

Place the ignition switch in the "OFF" or "LOCK" position.

#### **Models without Intelligent Key system:**

Place the ignition switch in the "LOCK" position, and remove the key.

2. Apply the parking brake.
3. Push the shift lever button and move the shift lever to the "N" (Neutral) position while holding down the shift lock release.

Place the ignition switch in the "ON" position to unlock the steering wheel. The vehicle may be moved to the desired location.

For model with Intelligent Key system: If the battery is discharged completely, the steering wheel cannot be unlocked. Do not move the vehicle with the steering wheel locked.

If the shift lever cannot be moved out of the "P" (Park) position, have a NISSAN dealer check the CVT system as soon as possible.



### **WARNING:**

**If the shift lever cannot be moved from the "P" (Park) position while the engine is running and the brake pedal is depressed, the stop lights may not work. Malfunctioning stop lights could cause an accident injuring yourself and others.**

## High fluid temperature protection mode

This transmission has a high fluid temperature protection mode. If the fluid temperature becomes too high (for example, when climbing steep grades in high temperature with heavy loads), engine power and, under some conditions, vehicle speed will be decreased automatically to reduce the chance of transmission damage. Vehicle speed can be controlled with the accelerator pedal, but engine and vehicle speed may be limited.

## Fail-safe

When the fail-safe operation occurs, the CVT will not be shifted to the selected driving position.

**If the vehicle is driven under extreme conditions, such as excessive wheel spinning and subsequent hard braking, the fail-safe system may be activated. This will occur even if all electrical circuits are functioning properly. In this case, place the ignition switch in the "OFF" position and wait for 10 seconds. Then turn the ignition switch back to the "ON" position. The vehicle should return to its normal operating condition. If it does not return to its normal operating condition, have a NISSAN dealer check the transmission and repair it if necessary.**



### WARNING:

When the fail-safe operation occurs, vehicle speed may be gradually reduced. The reduced speed may be lower than other traffic, which could increase the chance of a collision. Be especially careful when driving. If necessary, pull to the side of the road at a safe place and allow the transmission to return to normal operation, or have it repaired if necessary.

## DRIVING WITH MANUAL TRANSMISSION (MT)



### WARNING:

- **Do not downshift abruptly on slippery roads. This may cause a loss of vehicle control.**
- **Do not over-rev the engine when shifting to a lower gear. This may cause a loss of vehicle control or engine damage.**



### CAUTION:

- **Do not rest your foot on the clutch pedal while driving. This may damage the clutch system.**
- **Fully depress the clutch pedal before shifting to help prevent transmission damage.**
- **Stop the vehicle completely before shifting into the "R" (Reverse) position.**
- **When the vehicle is stopped for a period of time, for example waiting at stoplights, shift to the "N" (Neutral) position and release the clutch pedal with the foot brake pedal depressed.**
- **Do not shift to the "N" (Neutral) position while driving. Doing so may result in an accident due to loss of engine braking.**
- **Do not engage the clutch pedal rapidly when starting the vehicle. It may cause serious damage to the transmission.**

## Starting vehicle

1. After starting the engine, depress the clutch pedal to the floor and move the shift lever to the "1" (1st) or "R" (Reverse) position.
2. Slowly depress the accelerator pedal, releasing the clutch pedal and parking brake at the same time.

## Shifting gear

To change gears, or when upshifting or downshifting, fully depress the clutch pedal, shift into the appropriate gear, then slowly and smoothly release the clutch pedal.

To ensure smooth gear changes, fully depress the clutch pedal before operating the shift lever. If the clutch pedal is not fully depressed before the transmission is shifted, a gear noise may be heard. Transmission damage could occur.

Start the vehicle in the "1" (1st) position and shift to the "2" (2nd), "3" (3rd), "4" (4th) and "5" (5th) gear in sequence according to the vehicle speed.

If it is difficult to move the shift lever into the "R" (Reverse) or "1" (1st) position, shift to the "N" (Neutral) position, and then release the clutch pedal once. Fully depress the clutch pedal again and shift into "R" or "1".

## IDLING STOP SYSTEM (if equipped)

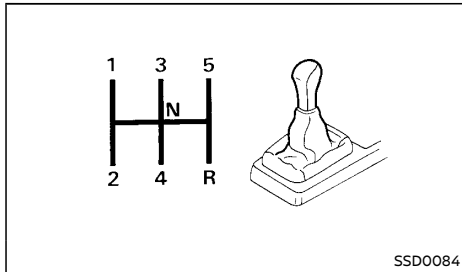

You cannot shift directly from the "5" (5th) position into the "R" (Reverse) position. First shift into the "N" (Neutral) position, then shift into the "R" (Reverse) position.

Suggested maximum speed in each gear  
Downshift to a lower gear if the engine is not running smoothly, or if you need to accelerate.

Do not exceed the maximum suggested speed (shown below) in any gear. For level road driving, use the highest gear suggested for that speed. Always observe posted speed limits, and drive according to the road conditions which will ensure safe operation. Do not over-rev the engine when shifting to a lower gear as it may cause engine damage or loss of vehicle control.

	km/h (MPH)
1st	45 (28)
2nd	82 (51)
3rd	121 (75)
4th	164 (102)
5th	— (—)

The Idling Stop System is designed to prevent unnecessary fuel consumption, exhaust emissions, and noise during a journey:

- When you stop the vehicle with the brake pedal depressed, the engine is turned off automatically. (To activate the Idling Stop System, depress the brake pedal firmly.)
- When you release the brake pedal, the engine is automatically turned on.



### CAUTION:

- The engine may restart automatically if required by the Idling Stop System.
- Place the ignition switch in the "OFF" position before opening the hood or performing any maintenance. Failure to do so may result in serious injuries due to automatic engine restart.
- Always place the ignition switch in the "OFF" position before leaving your vehicle, as the system may have turned the engine off, but the ignition will still be on and automatic restart may occur.

Failure to do this may result in a flat battery.

### NOTE:

For model with Idling Stop System, use the special battery that is enhanced in regard to the charge-discharge capacity and life performance. Avoid using a non-special battery for the Idling Stop System, as this may cause early deterioration of the battery or a malfunction of the Idling Stop System. For the battery, it is recommended to use Genuine NISSAN parts. For more information, contact a NISSAN dealer.

### NOTE:

The Idling Stop System will not activate under the following conditions:

- when the engine is kept idling without any driving after the engine is turned on.
- when the engine coolant temperature is low.
- when the battery capacity is low.
- when the battery temperature is low.
- when the vehicle is moved.
- when the vacuum in the brake servo decreases.
- when the engine hood is opened with the engine running.
- when the engine is turned on with the engine hood open.
- when the driver's seat belt is not fastened.
- when the driver's door is open.
- when the steering wheel is operated.
- when the Idling Stop System indicator light (if equipped) on the meter blinks at a low speed.
- when the Idling Stop System indicator (if equipped) in the vehicle information display blinks.
- when the Idling Stop OFF switch is turned on.
- when the vehicle is traveling at altitudes higher than 2,000 m (6,562 ft).
- when the power consumption is large.
- when the accelerator pedal is depressed.
- when the shift lever is in the "R" (Reverse) position.
- when the brake pedal is not firmly depressed.

- when stopping the vehicle on steep sloping roads.
- when the electric power steering warning light, the Anti-lock Braking System (ABS) warning light, or the Vehicle Dynamic Control (VDC) warning light illuminates.

**NOTE:**

The engine will not restart even if the brake pedal is released while the Idling Stop System is activated under the following condition:

- when the shift lever is in the "P" (Park) position.
- when the engine hood is opened.

**NOTE:**

It may take some time until the Idling Stop System activates under the following conditions:

- when the battery is discharged.
- when the outside temperature is low or high.
- when the battery is replaced or the battery terminal is disconnected for extended periods and then reconnected.

**NOTE:**

When the Idling Stop indicator (light) illuminates, the engine starts running automatically under at least one of the following conditions:

- the brake pedal is released with the shift lever in the "D" (Drive) or "N" (Neutral) position.
- the shift lever is placed in the "D" (Drive) or "R" (Reverse) position from the "N" (Neutral) or "P" (Park) position.

- the driver's seat belt is unfastened, or the driver's door is open.
- the battery voltage becomes low (due to electrical load from other vehicle systems like headlights, heaters, etc., or auxiliary devices connected to the 12 volt socket inside the vehicle).
- the vehicle speed is above about 2 km/h (1 MPH).
- when more than 3 minutes have elapsed since the Idling Stop System was active.
- when the accelerator pedal is depressed.
- when the steering wheel is operated. (The steering wheel operation may become heavy, but this is not a malfunction.)
- when the battery capacity is low.
- when the power consumption is high.
- when the shift lever is placed in the "R" (Reverse) position.

**NOTE:**

The following condition will prevent the Idling Stop System from automatically restarting the engine. Starting the engine with the ignition switch operation is then necessary:

- the hood is open.

Use this system while waiting at stoplight, etc. When the vehicle is stopped for long periods of time, turn off the engine.

When the engine is stopped by the Idling Stop System, cooling, heating (if equipped) and dehumidifying functions will be deactivated. To avoid the air conditioning functions from being deactivated, turn off the Idling Stop mode by pressing the Idling Stop OFF switch.

### IDLING STOP SYSTEM INDICATOR LIGHT (if equipped)

The Idling Stop System indicator light illuminates in the meter when the Idling Stop System is activated.

For more details, see "Idling Stop System indicator light" (P.2-16).

### IDLING STOP SYSTEM DISPLAY (if equipped)

The status of the Idling Stop System can be checked in the vehicle information display.

#### Idling Stop System ON or OFF

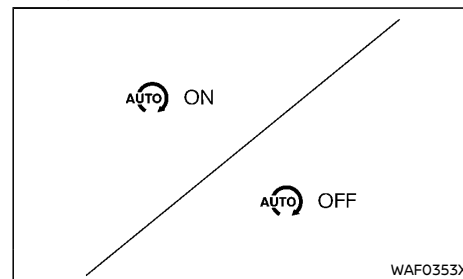

If the Idling Stop System is activated or deactivated using the Idling Stop OFF switch, the message is shown.



## Fuel saved and engine stop time

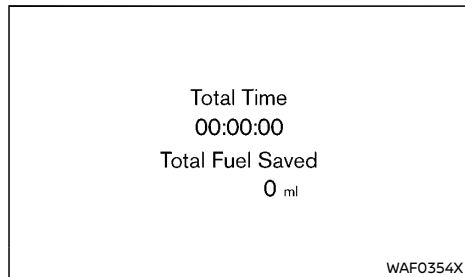

The fuel saved and the engine stop time mode shows the following items:

- The fuel saved shows the estimated quantity of fuel that were saved by the Idling Stop System every time the engine is automatically stopped.
- The engine stop time shows the time that the engine has been stopped for by the Idling Stop System.

For more information, "4-5. Idling Stop System" (P.2-29).

## Auto start deactivation

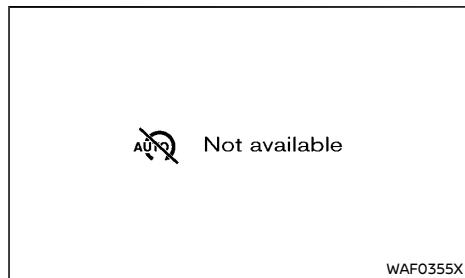

If the engine stops when the Idling Stop System is activated, and will not start automatically, the message is shown.

## Key LOCK warning

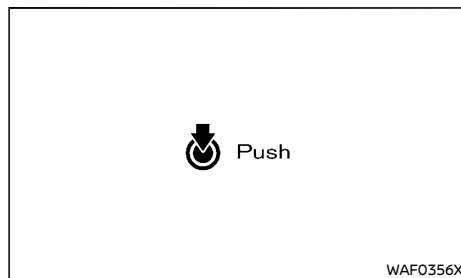

The information is displayed and a buzzer sounded to remind the driver to place the ignition switch "OFF" to avoid a flat battery.

The message can only be cleared by pushing the ignition switch "OFF" (or restarting the engine).

## System fault

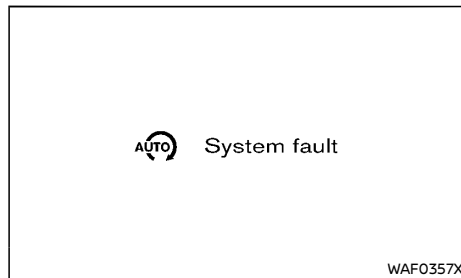

This message is displayed when the Idling Stop

System is malfunctioning.

Have the system checked by a NISSAN dealer.

## IDLING STOP OFF SWITCH

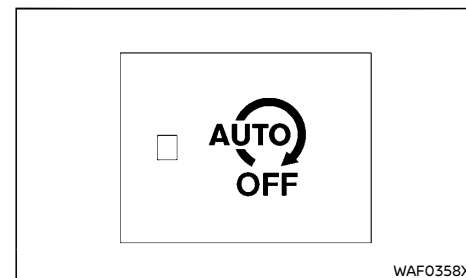

The system can be temporarily deactivated by pressing the Idling Stop OFF switch. Pressing the switch again or restarting the engine by using the ignition switch will reactivate the Idling Stop System.

- When the Idling Stop System is deactivated while the engine is running, the engine is prevented from automatically stopping.
- When the Idling Stop System is deactivated after the engine has been automatically stopped by the Idling Stop System, the engine will immediately restart if suitable conditions are present. The engine will then be prevented from automatically stopping during the same journey.
- Whenever the Idling Stop System is deactivated, the indicator light on the Idling Stop OFF switch illuminates. In this condition the Idling Stop System cannot prevent unnecessary fuel consumption, exhaust emissions, or noise during your journey.

## VEHICLE DYNAMIC CONTROL (VDC) SYSTEM





- If the Idling Stop System is malfunctioning, the indicator light on the Idling Stop OFF switch illuminates.

### NOTE:

The Idling Stop System ON or OFF message (if equipped) is displayed for a few seconds in the vehicle information display when the Idling Stop OFF switch is pressed. See "Idling Stop System ON or OFF" (P.5-16).



### WARNING:

- The VDC system is designed to help the driver maintain stability but does not prevent accidents due to abrupt steering operation at high speeds or by careless or dangerous driving techniques. Reduce vehicle speed and be especially careful when driving and cornering on slippery surfaces and always drive carefully.
- Do not modify the vehicle's suspension. If suspension parts such as shock absorbers, struts, springs, stabilizer bars, bushings and wheels are not NISSAN recommended for your vehicle or are extremely deteriorated, the VDC system may not operate properly. This could adversely affect vehicle handling performance, and the VDC warning light  may illuminate.
- If brake related parts such as brake pads, rotors and calipers are not NISSAN recommended or are extremely deteriorated, the VDC system may not operate properly and the VDC warning light  may illuminate.
- If engine control related parts are not NISSAN recommended or are extremely deteriorated, the VDC warning light  may illuminate.
- When driving on extremely inclined surfaces such as higher banked corners, the VDC system may not operate properly and the VDC warning light  may illuminate. Do not drive on these types of roads.
- When driving on an unstable surface such as a turntable, ferry, elevator or ramp, the VDC warning light  may illuminate.

**This is not a malfunction. Restart the engine after driving onto a stable surface.**

- If wheels or tires other than the NISSAN recommended ones are used, the VDC system may not operate properly and the VDC warning light  may illuminate.
- The VDC system is not a substitute for winter tires or tire chains on a snow covered road.

The Vehicle Dynamic Control (VDC) system uses various sensors to monitor driver inputs and vehicle motion. Under certain driving conditions, the VDC system helps to perform the following functions.

- Controls brake pressure to reduce wheel slip on one slipping drive wheel so power is transferred to a non slipping drive wheel on the same axle.
- Controls brake pressure and engine output to reduce drive wheel slip based on vehicle speed (traction control function).
- Controls brake pressure at individual wheels and engine output to help the driver maintain control of the vehicle in the following conditions:
  - understeer (vehicle tends to not follow the steered path despite increased steering input)
  - oversteer (vehicle tends to spin due to certain road or driving conditions).

The VDC system can help the driver to maintain control of the vehicle, but it cannot prevent loss of vehicle control in all driving situations.



When the VDC system operates, the VDC warning light  in the instrument panel flashes so note the following:

- The road may be slippery or the system may determine some action is required to

help the vehicle on the steered path.

- You may feel a pulsation in the brake pedal and hear a noise or vibration from under the hood. This is normal and indicates that the VDC system is working properly.
- Adjust your speed and driving to the road conditions.

If a malfunction occurs in the system, the VDC warning light  illuminates in the instrument panel. The VDC system automatically turns off.

The vehicle information display or the VDC OFF switch is used to turn off the VDC system. The VDC off indicator light  illuminates to indicate the VDC system is off. When the VDC system is turned off the VDC system still operates to prevent one drive wheel from slipping by transferring power to a non slipping drive wheel. The VDC warning light  flashes if this occurs. All other VDC functions are off and the VDC warning light  will not flash. The VDC system is automatically reset to on when the ignition switch is placed in the "OFF" position then back to the "ON" position.

See "Vehicle Dynamic Control (VDC) warning light" (P.2-15) and "Vehicle Dynamic Control (VDC) off indicator light" (P.2-17).

The computer has a built-in diagnostic feature that tests the system each time you start the engine and move the vehicle forward or in reverse at a slow speed. When the self-test occurs, you may hear a "clunk" noise and/or feel a pulsation in the brake pedal. This is normal and is not an indication of a malfunction.

## HOW TO TURN OFF THE VDC SYSTEM



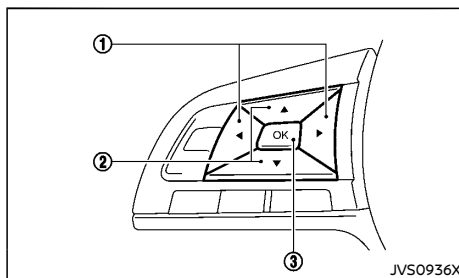
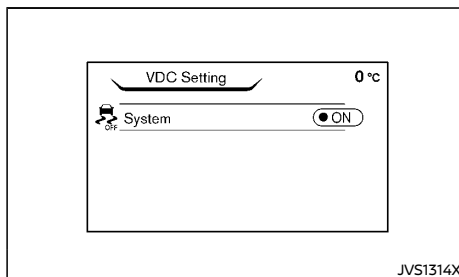

The vehicle should be driven with the Vehicle Dynamic Control (VDC) system ON for most driving conditions.

When the vehicle is stuck in mud or snow, the VDC system reduces the engine output to reduce wheel spin. The engine speed will be reduced even if the accelerator is depressed to the floor. If maximum engine power is needed to free a stuck vehicle, turn the VDC system off.

### Type A:





To turn off the VDC system, perform the following steps in the vehicle information display.

1. Use the   switch ① on the steering wheel until "Settings" is displayed.
2. Use the  switch ② to select "VDC Setting" and then push OK ③.
3. Select "  System" and push OK ③. The  indicator light will illuminate.

Turn "VDC Setting" back on in the vehicle information display or restart the engine to turn on the VDC system.

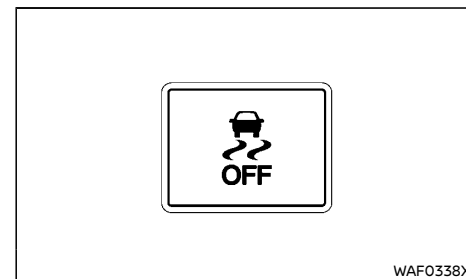
### Type B:



To turn off the VDC system, push the VDC OFF switch. The  indicator light will illuminate.

Push the VDC OFF switch again or restart the engine to turn ON the system.

## HILL START ASSIST SYSTEM



### WARNING:

- **Never rely solely on the hill start assist system to prevent the vehicle from moving backward on a hill. Always drive carefully and attentively. Depress the brake pedal when the vehicle is stopped on a steep hill. Be especially careful when stopped on a hill on frozen or muddy roads. Failure to prevent the vehicle from rolling backwards may result in a loss of control of the vehicle and possible serious injury or death.**
- **The hill start assist system is not designed to hold the vehicle at a standstill on a hill. Depress the brake pedal when the vehicle is stopped on a steep hill. Failure to do so may cause the vehicle to roll backwards and may result in a collision or serious personal injury.**
- **The hill start assist system may not prevent the vehicle from rolling backwards on a hill under all load or road conditions. Always be prepared to depress the brake pedal to prevent the vehicle from rolling backwards. Failure to do so may result in a collision or serious personal injury.**

The hill start assist system automatically keeps the brakes applied to help prevent the vehicle from rolling backwards in the time it takes the driver to release the brake pedal and apply the accelerator when the vehicle is stopped on a hill.

The hill start assist system will operate automatically under the following conditions:

- The transmission is shifted to a forward or reverse gear.

- The vehicle is stopped completely on a hill by applying the brake.

The maximum holding time is 2 seconds. After 2 seconds the vehicle will begin to roll back and the hill start assist system will stop operating completely.

The hill start assist system will not operate when the transmission is shifted to the "N" (Neutral) or "P" (Park) position or on a flat and level road.

When the Vehicle Dynamic Control (VDC) warning light illuminates in the meter, the hill start assist system will not operate. (See "Vehicle Dynamic Control (VDC) warning light" (P.2-15).)

## BLIND SPOT WARNING (BSW) (if equipped)



### WARNING:

**Failure to follow the warnings and instructions for proper use of the BSW system could result in serious injury or death.**

- **The BSW system is not a replacement for proper driving procedures and is not designed to prevent contact with vehicles or objects. When changing lanes, always use the side and rear mirrors and turn and look in the direction your vehicle will move to ensure it is safe to change lanes. Never rely solely on the BSW system.**

The BSW system helps alert the driver of other vehicles in adjacent lanes when changing lanes.

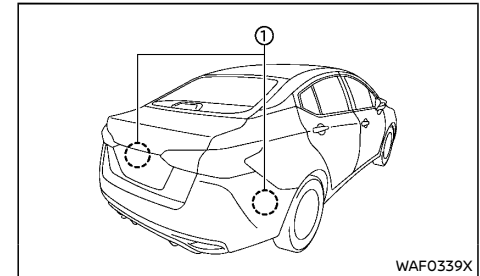

The BSW system uses radar sensors ① installed near the rear bumper to detect other vehicles in an adjacent lane.

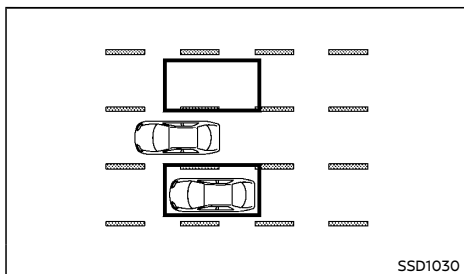

#### Detection zone

The radar sensors can detect vehicles on either side of your vehicle within the detection zone shown as illustrated. This detection zone starts from the outside mirror of your vehicle and extends approximately 3.0 m (10 ft) behind the rear bumper, and approximately 3.0 m (10 ft) sideways.

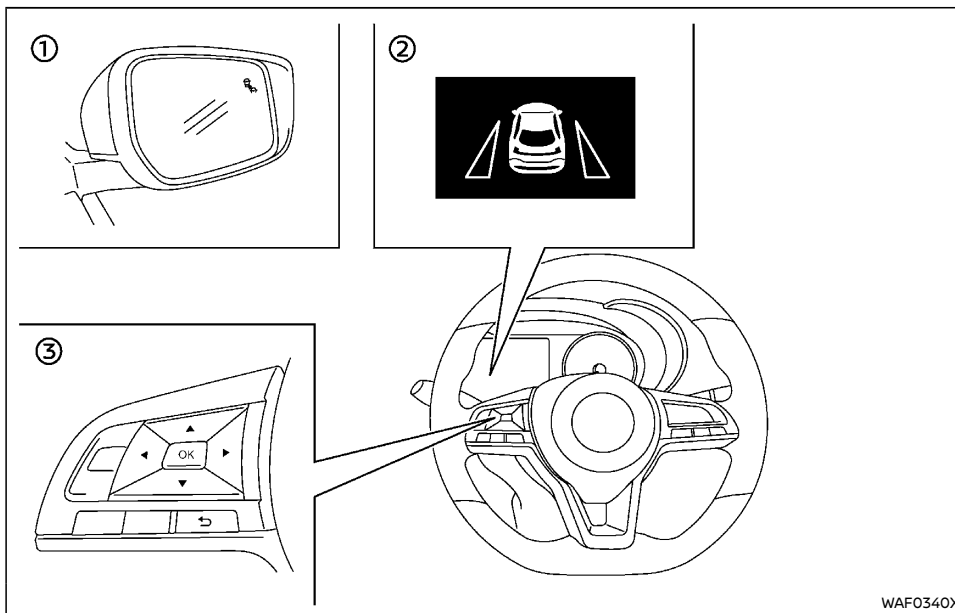

- ① Side indicator light (on the mirror surface)
- ② BSW indicator
- ③ Steering-wheel-mounted controls (left side)

#### BSW SYSTEM OPERATION

The BSW system operates above approximately 32 km/h (20 MPH).

If the radar sensors detect a vehicle in the detection zone, the side indicator light ① illuminates.

If the turn signal is then activated, the system chimes (twice) and the side indicator light flashes. The side indicator light continues to flash until the detected vehicle leaves the detection zone.

The side indicator light illuminates for a few

seconds when the ignition switch is placed in the "ON" position.

The brightness of the side indicator light is adjusted automatically depending on the brightness of the ambient light.

If a vehicle comes into the detection zone after the driver activates the turn signal, then only the side indicator light flashes and no chime sounds. For additional information, refer to "BSW driving situations" (P.5-23).

## HOW TO ENABLE/DISABLE THE BSW SYSTEM

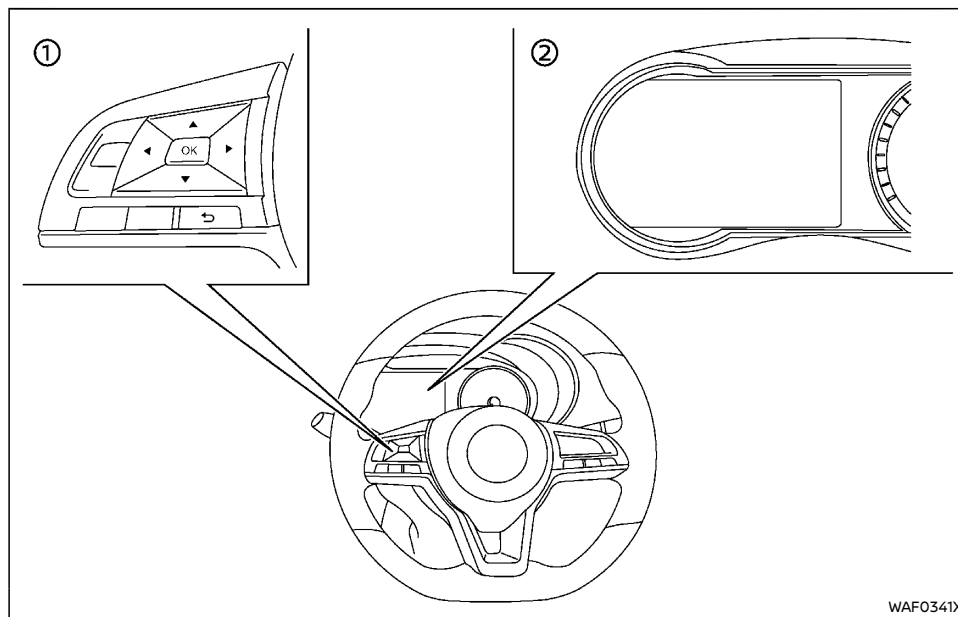

WAF0341X

① Steering-wheel-mounted controls (left side)

② Vehicle information display

Perform the following steps to enable or disable the BSW system.

1. Push the ◀ ▶ switch until "Settings" appears in the vehicle information display. Use the ⬆ switch to select "Driver Assistance". Then push OK.

2. Select "Blind Spot" and push OK.

3. Select "Blind Spot Warning" and push OK.

4. The BSW indicator in the vehicle information display will appear when the BSW system is enabled.

#### NOTE:

When enabling/disabling the system, the system will retain current settings even if the engine is restarted.

#### BSW SYSTEM LIMITATIONS



#### WARNING:

Listed below are the system limitations for the BSW system. Failure to operate the vehicle in accordance with these system limitations could result in serious injury or death.

- The BSW system cannot detect all vehicles under all conditions.
- The radar sensors may not be able to detect and activate BSW when certain objects are present such as:
  - Pedestrians, bicycles, animals.
  - Vehicles such as motorcycles, low height vehicles, or high ground clearance vehicles.
  - Oncoming vehicles.
  - Vehicles remaining in the detection zone when you accelerate from a stop.
  - A vehicle merging into an adjacent lane at a speed approximately the same as your vehicle.
  - A vehicle approaching rapidly from behind.
  - A vehicle which your vehicle overtakes rapidly.
  - A vehicle that passes through the detection zone quickly.
- When overtaking several vehicles in a row, the vehicles after the first vehicle may not be detected if they are traveling close together.
- The radar sensor's detection zone is designed based on a standard lane width. When driving in a wider lane, the radar sensors may not detect vehicles in an adjacent lane. When driving in a narrow lane, the radar sensors may detect vehicles driving two lanes away.
- The radar sensors are designed to ignore most stationary objects, however objects such as guardrails, walls, foliage and parked vehicles may occasionally be detected. This is a normal operation condition.
- The following conditions may reduce the ability of the radar to detect other vehicles:
  - Severe weather
  - Road spray
  - Ice/frost/dirt build-up on the vehicle
- Do not attach stickers (including transparent material), install accessories or apply additional paint near the radar sensors. These conditions may reduce the ability of the radar to detect other vehicles.
- Excessive noise (for example, audio system volume, open vehicle window) will interfere with the chime sound, and it may not be heard.

#### BSW DRIVING SITUATIONS

Another vehicle approaching from behind

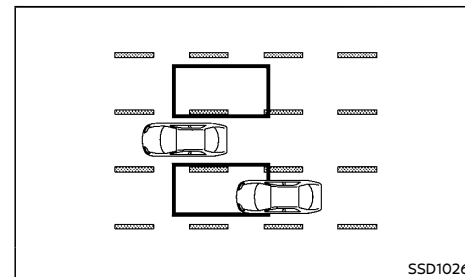

SSD1026

Illustration 1 - Approaching from behind

Illustration 1: The side indicator light illuminates if a vehicle enters the detection zone from behind in an adjacent lane.

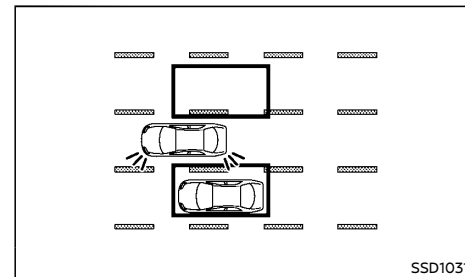

SSD1031

Illustration 2 - Approaching from behind

Illustration 2: If the driver activates the turn signal, then the system chimes (twice) and the side indicator light flashes.

**NOTE:**

- The radar sensors may not detect vehicles which are approaching rapidly from behind.
- If the driver activates the turn signal before a vehicle enters the detection zone, the side indicator light will flash but no chime will sound when the other vehicle is detected.

Overtaking another vehicle

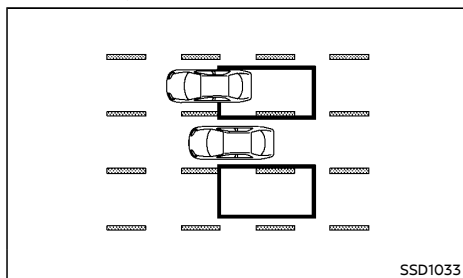

**Illustration 3 - Overtaking another vehicle**  
Illustration 3: The side indicator light illuminates if you overtake a vehicle and that vehicle stays in the detection zone for approximately 2 seconds.

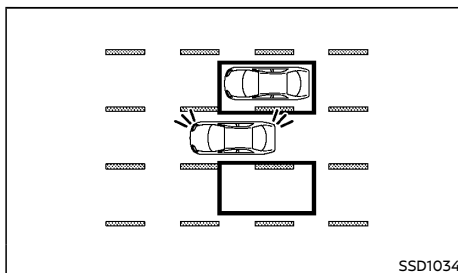
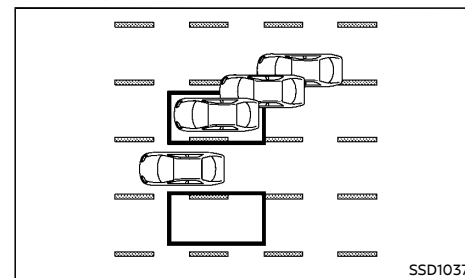

**Illustration 4 - Overtaking another vehicle**  
Illustration 4: If the driver activates the turn signal while another vehicle is in the detection zone, then the system chimes (twice) and the side indicator light flashes.

**NOTE:**

- When overtaking several vehicles in a row, the vehicles after the first vehicle may not be detected if they are traveling close together.
- The radar sensors may not detect slower moving vehicles if they are passed quickly.
- If the driver activates the turn signal before a vehicle enters the detection zone, the side indicator light will flash but no chime will sound when the other vehicle is detected.

Entering from the side



**Illustration 5 - Entering from the side**  
Illustration 5: The side indicator light illuminates if a vehicle enters the detection zone from either side.

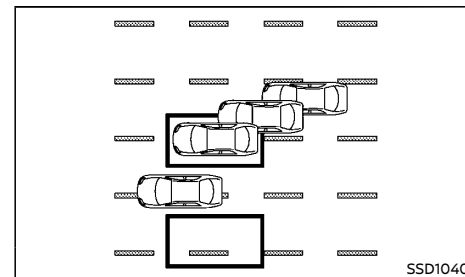

**Illustration 6 - Entering from the side**  
Illustration 6: If the driver activates the turn signal, then the system chimes (twice) and the side indicator light flashes.

**NOTE:**

- The radar sensors may not detect a vehicle which is traveling at about the same speed as your vehicle when it enters the detection zone.



- If the driver activates the turn signal before a vehicle enters the detection zone, the side indicator light will flash but no chime will sound when the other vehicle is detected.

#### SYSTEM TEMPORARILY UNAVAILABLE

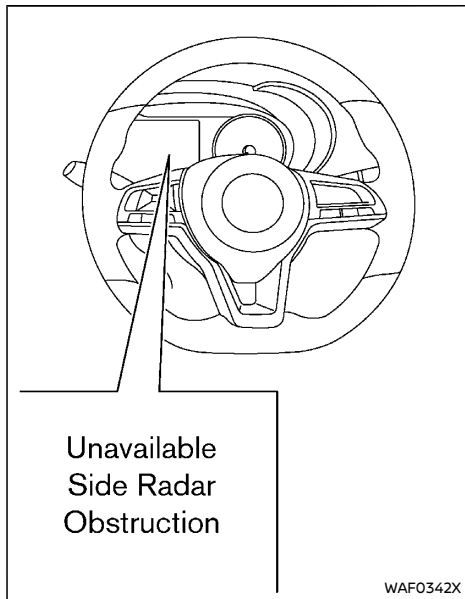

When radar blockage is detected, the BSW system will be turned off automatically, a chime will sound and the "Unavailable: Side Radar Obstruction" warning message will appear in the vehicle information display.

The system is not available until the conditions

no longer exist.

The radar sensors may be blocked by temporary ambient conditions such as splashing water, mist or fog. The blocked condition may also be caused by objects such as ice, frost or dirt obstructing the radar sensors.

#### NOTE:

**If the BSW system stops working, the RCTA system will also stop working.**

#### Action to take:

When the above conditions no longer exist, the system will resume automatically.

If the "Unavailable: Side Radar Obstruction" warning message continues to appear, have the system checked by a NISSAN dealer.

#### SYSTEM MALFUNCTION

When the BSW system malfunctions, it will be turned off automatically and the "Malfunction: See Owner's Manual" warning message will appear in the vehicle information display.

#### NOTE:

**If the BSW system stops working, the RCTA system will also stop working.**

#### Action to take:

Stop the vehicle in a safe location, turn the engine off and restart the engine. If the message continues to appear, have the BSW system checked by a NISSAN dealer.

#### SYSTEM MAINTENANCE

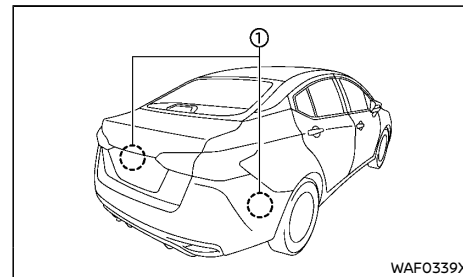

The two radar sensors ① for the BSW system are located near the rear bumper. Always keep the area near the radar sensors clean.

The radar sensors may be blocked by temporary ambient conditions such as splashing water, mist or fog.

The blocked condition may also be caused by objects such as ice, frost or dirt obstructing the radar sensors.

Check for and remove objects obstructing the area around the radar sensors.

Do not attach stickers (including transparent material), install accessories or apply additional paint near the radar sensors.

Do not strike or damage the area around the radar sensors.

See a NISSAN dealer if the area around the radar sensors is damaged due to a collision.

For the radio approval numbers and information, see "Radio approval number and information" (P.9-8).

## REAR CROSS TRAFFIC ALERT (RCTA) (if equipped)



### WARNING:

Failure to follow the warnings and instructions for proper use of the RCTA system could result in serious injury or death.

- The RCTA system is not a replacement for proper driving procedures and is not designed to prevent contact with vehicles or objects. When backing out of a parking space, always use the side and rear mirrors and turn and look in the direction your vehicle will move. Never rely solely on the RCTA system.

The RCTA system will assist you when backing out from a parking space. When the vehicle is in reverse, the system is designed to detect other vehicles approaching from the right or left of the vehicle. If the system detects cross traffic, it will alert you.

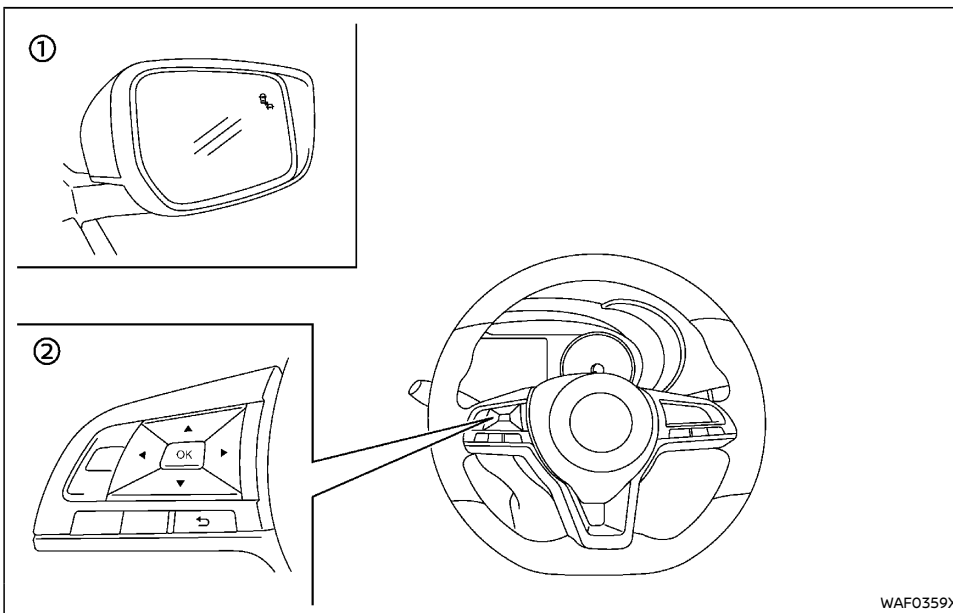

WAF0359X

- ① Side indicator light (on the mirror surface)
- ② Steering-wheel-mounted controls (left side)

### RCTA SYSTEM OPERATION

The RCTA system can help alert the driver of an approaching vehicle when the driver is backing out of a parking space.

When the shift position is in "R" (Reverse) and the vehicle speed is less than approximately 8 km/h (5 MPH), the RCTA system is operational.

If the radar detects an approaching vehicle from either side, the system chimes (once) and the side indicator light flashes on the side the vehicle is approaching from.

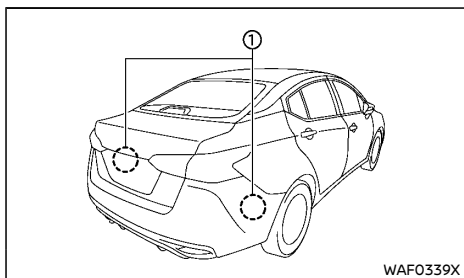
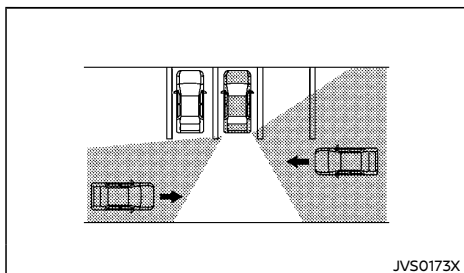

The RCTA system uses radar sensors ① installed on both sides near the rear bumper to detect an approaching vehicle.

The radar sensors ① can detect an approaching vehicle from up to approximately 20 m (66 ft) away.

## HOW TO ENABLE/DISABLE THE RCTA SYSTEM

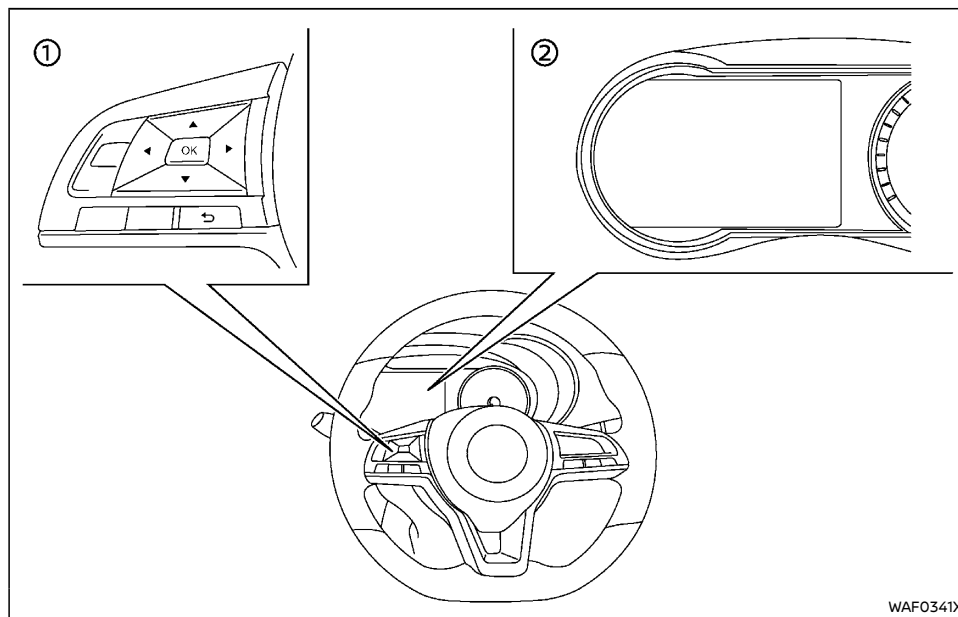

① Steering-wheel-mounted controls (left side)

② Vehicle information display

Perform the following steps to enable or disable the RCTA system.

1. Push the ◀ ▶ switch until "Settings" appears in the vehicle information display. Use the ⬇ switch to select "Driver Assistance". Then push OK.

2. Select "Parking Aids" and push OK.

3. Select "Cross Traffic" and push OK.

### NOTE:

**When enabling/disabling the system, the system setting will be retained even if the engine is restarted.**

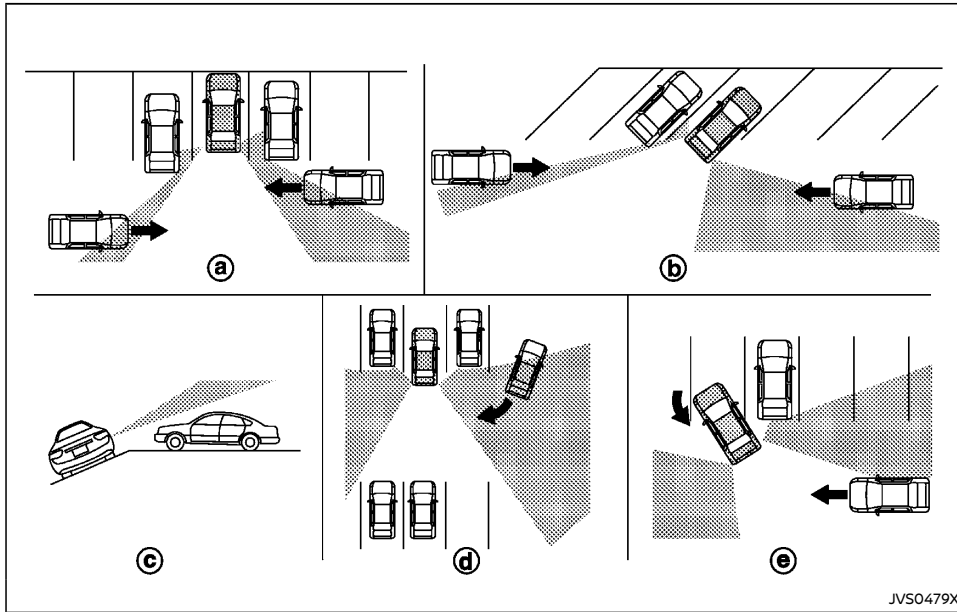

JV50479X

## RCTA SYSTEM LIMITATIONS

### WARNING:

Listed below are the system limitations for the RCTA system. Failure to operate the vehicle in accordance with these system limitations could result in serious injury or death.

- Always check surroundings and turn to check what is behind you before backing up. The radar sensors detect approaching (moving) vehicles. The radar sensors

cannot detect every object such as:

- Pedestrians, bicycles, motorcycles, animals or child-operated toy vehicles
- A vehicle that is passing at speeds greater than approximately 30 km/h (19 MPH)
- A vehicle that is passing at speeds lower than approximately 8 km/h (5 MPH)

- The radar sensors may not detect approaching vehicles in certain situations:
  - Illustration (a): When a vehicle parked next to you obstructs the beam of the radar sensor.
  - Illustration (b): When the vehicle is parked in an angled parking space.
  - Illustration (c): When the vehicle is parked on inclined ground.
  - Illustration (d): When an approaching vehicle turns into your vehicle's parking lot aisle.
  - Illustration (e): When the angle formed by your vehicle and approaching vehicle is small
- The following conditions may reduce the ability of the radar to detect other vehicles:
  - Severe weather
  - Road spray
  - Ice/frost/dirt build-up on the vehicle
- Do not attach stickers (including transparent material), install accessories or apply additional paint near the radar sensors. These conditions may reduce the ability of the radar to detect other vehicles
- Excessive noise (e.g. audio system volume, open vehicle window) will interfere with the chime sound, and it may not be heard.

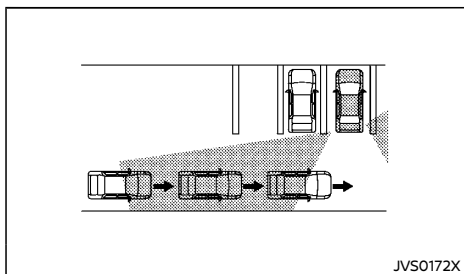

Illustration 1

JVS0172X

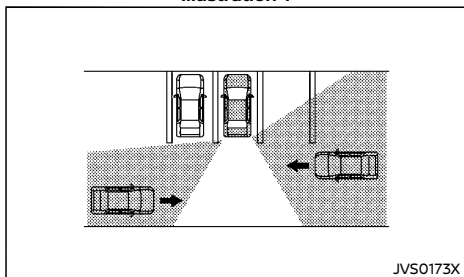

Illustration 2

JVS0173X

**NOTE:**

In the case of several vehicles approaching in a row (Illustration 1) or in the opposite direction (Illustration 2), a chime may not be sounded by the RCTA system after the first vehicle passes the sensors.

**SYSTEM TEMPORARILY UNAVAILABLE**

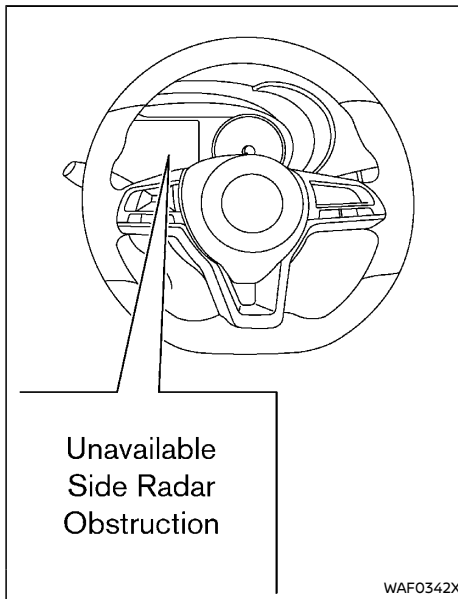

WAF0342X

When radar blockage is detected, the system will be deactivated automatically. The "Unavailable: Side Radar Obstruction" warning message will appear in the vehicle information display.

The systems are not available until the conditions no longer exist.

The radar sensors may be blocked by temporary ambient conditions such as splashing water, mist or fog.

The blocked condition may also be caused by objects such as ice, frost or dirt obstructing the

radar sensors.

**NOTE:**

If the BSW system stops working, the RCTA system will also stop working.

**Action to take:**

When the above conditions no longer exist, the system will resume automatically.

If the "Unavailable: Side Radar Obstruction" warning message continues to appear, have the system checked by a NISSAN dealer.

**SYSTEM MALFUNCTION**

When the RCTA system malfunctions, it will turn off automatically. The "Malfunction: See Owner's Manual" warning message will appear in the vehicle information display.

**NOTE:**

If the BSW system stops working, the RCTA system will also stop working.

**Action to take:**

Stop the vehicle in a safe location, turn the engine off and restart the engine. If the message continues to appear, have the system checked by a NISSAN dealer.

## INTELLIGENT EMERGENCY BRAKING SYSTEM (if equipped)

### SYSTEM MAINTENANCE

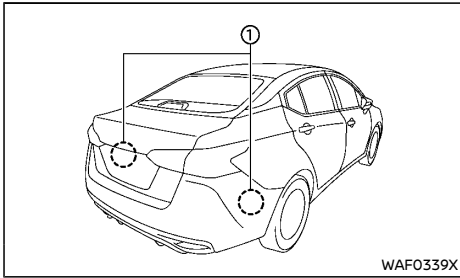

The two radar sensors ① for the RCTA system are located near the rear bumper. Always keep the area near the radar sensors clean.

The radar sensors may be blocked by temporary ambient conditions such as splashing water, mist or fog.

The blocked condition may also be caused by objects such as ice, frost or dirt obstructing the radar sensors.

Check for and remove objects obstructing the area around the radar sensors.

Do not attach stickers (including transparent material), install accessories or apply additional paint near the radar sensors.

Do not strike or damage the area around the radar sensors. It is recommended that you visit a NISSAN dealer if the area around the radar sensors is damaged due to a collision.

For the radio approval numbers and information, see "Radio approval number and information" (P.9-8).



### WARNING:

Failure to follow the warnings and instructions for proper use of the Intelligent Emergency Braking system could result in serious personal injury or death.

- The Intelligent Emergency Braking system is a supplemental aid to the driver. It is not a replacement for the driver's attention to traffic conditions or responsibility to drive safely. It cannot prevent accidents due to carelessness or dangerous driving techniques.
- The Intelligent Emergency Braking system does not function in all driving, traffic, weather and road conditions.

The Intelligent Emergency Braking system can assist the driver when there is a risk of a forward collision with the vehicle ahead in the traveling lane.

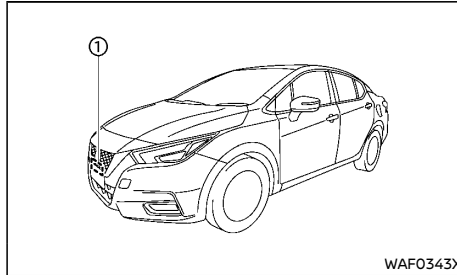

The Intelligent Emergency Braking system uses a radar sensor ① located on the front of the vehicle to measure the distance to the vehicle ahead in the same lane.

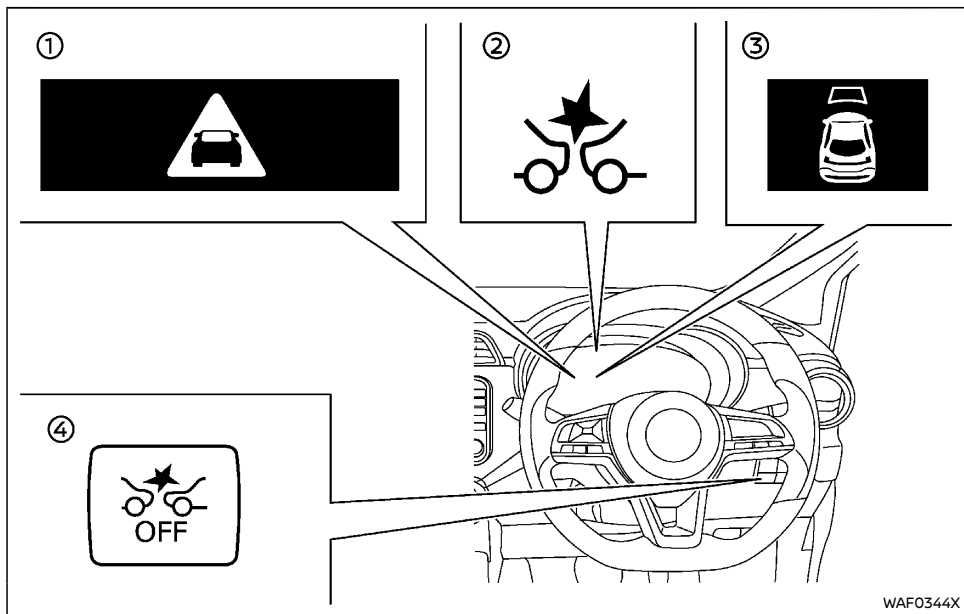

- ① Intelligent Emergency Braking emergency warning indicator (in the vehicle information display) (for models without Intelligent Emergency Braking system OFF switch)
- ② Intelligent Emergency Braking system warning light (on the meter panel)
- ③ Intelligent Emergency Braking system indicator (in the vehicle information display) (for models without Intelligent Emergency Braking system OFF switch)
- ④ Intelligent Emergency Braking system OFF switch (if equipped)

## INTELLIGENT EMERGENCY BRAKING SYSTEM OPERATION

The Intelligent Emergency Braking system will function when your vehicle is driven at speeds above approximately 5 km/h (3 MPH).

If a risk of a forward collision is detected, detection system will firstly provide the warning to the driver by illuminating the indicator (yellow) ③\*1 or flashing the warning light ②\*2, and providing an audible alert. (\*1: models without Intelligent Emergency Braking system OFF switch, \*2: models with Intelligent Emergency Braking system OFF switch)

If the driver applies the brakes quickly and forcefully after the warning, and the Intelligent Emergency Braking system detects that there is still the possibility of a forward collision, the system will automatically increase the braking force.

If the driver does not take action, the Intelligent Emergency Braking system issues the second visual (flashing) (red) ①\*1 or flashes the warning light ②\*2, and provides audible warning. If the driver releases the accelerator pedal, then the system applies partial braking. (\*1: models without Intelligent Emergency Braking system OFF switch, \*2: models with Intelligent Emergency Braking system OFF switch)

If the risk of a collision becomes imminent, the Intelligent Emergency Braking system applies harder braking automatically.

While the Intelligent Emergency Braking system is operating, you may hear the sound of brake operation. This is normal and indicates that the Intelligent Emergency Braking system is operating properly.

**NOTE:**

The vehicle's stop lights come on when braking is performed by the Intelligent Emergency Braking system.

Depending on vehicle speed and distance to the vehicle ahead, as well as driving and roadway conditions, the system may help the driver avoid a forward collision or may help mitigate the consequences of a collision should one be unavoidable.

If the driver is handling the steering wheel, accelerating or braking, the Intelligent Emergency Braking system will function later or will not function.

The automatic braking will cease under the following conditions:

- When the steering wheel is turned as far as necessary to avoid a collision.
- When the accelerator pedal is depressed.
- When there is no longer a vehicle detected ahead.

If the Intelligent Emergency Braking system has stopped the vehicle, the vehicle will remain at a standstill for approximately 2 seconds before the brakes are released.

**TURNING THE INTELLIGENT EMERGENCY BRAKING SYSTEM ON/OFF**

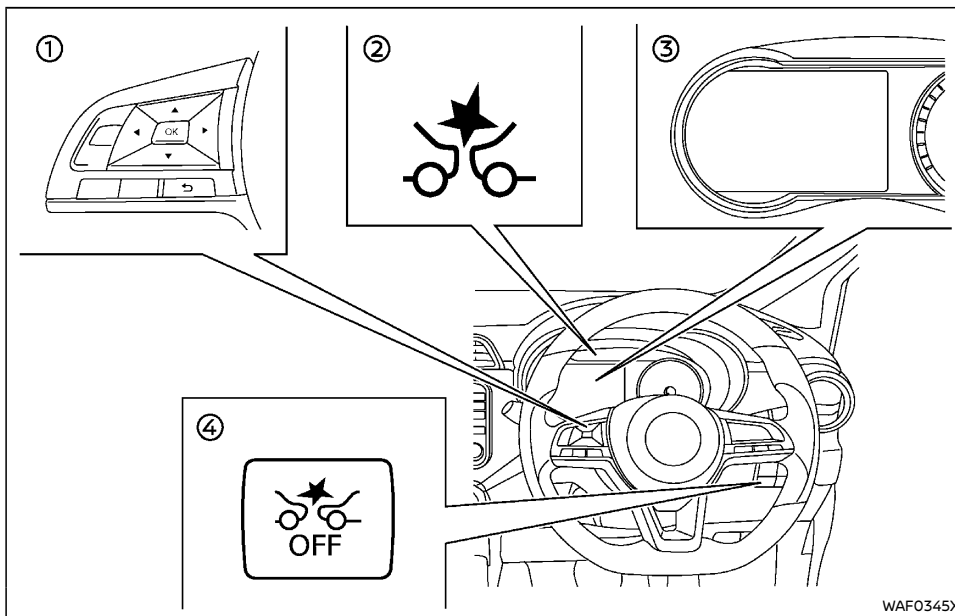

- ① Steering-wheel-mounted controls (left side) (for models without Intelligent Emergency Braking system OFF switch)
- ② Intelligent Emergency Braking system warning light (on the meter panel)
- ③ Vehicle information display (for models without Intelligent Emergency Braking system OFF switch)
- ④ Intelligent Emergency Braking system OFF switch (if equipped)

**For models without Intelligent Emergency Braking system OFF switch:**

Perform the following steps to enable or disable the Intelligent Emergency Braking system.

1. Push the ◀ ▶ switch until "Settings" appears in the vehicle information display. Use the ⬆ switch to select "Driver Assistance". Then push OK.



2. Select "Emergency Brake" and push OK.
3. Select "Front" and push OK to enable or disable the system.

#### **For models with Intelligent Emergency Braking system OFF switch:**

Push the Intelligent Emergency Braking system OFF switch for more than approximately 3 seconds to turn the Intelligent Emergency Braking system OFF or ON.

When the Intelligent Emergency Braking system is turned off, the Intelligent Emergency Braking system warning light (orange) illuminates.

#### **NOTE:**

The Intelligent Emergency Braking system will be automatically turned ON when the engine is restarted.

#### **INTELLIGENT EMERGENCY BRAKING SYSTEM LIMITATIONS**



#### **WARNING:**

Listed below are the system limitations for the Intelligent Emergency Braking system. Failure to operate the vehicle in accordance with these system limitations could result in serious injury or death.

- The Intelligent Emergency Braking system cannot detect all vehicles under all conditions.
- The radar sensor does not detect the following objects:
  - Pedestrians, animals or obstacles in the roadway
  - Animals of any size

- Obstacles (for example, cargo or debris) on the roadway or roadside
- Oncoming or crossing vehicles
- Vehicles where the tires are difficult to see or the shape of the rear of the vehicle is unclear or obstructed.
- Parked vehicles
- The radar sensor has some performance limitations. If a stationary vehicle is in the vehicle's path, the Intelligent Emergency Braking system will not function when the vehicle is driven at speeds over approximately 80 km/h (50 MPH).
- The radar sensor may not detect a vehicle ahead in the following conditions:
  - In poor visibility conditions (such as rain, snow, fog, dust storms, sand storms, smoke, and road spray from other vehicles).
  - If dirt, ice, snow, fog or other material is covering the radar sensor area.
  - When driving on a steep downhill slope, on roads with sharp curves, and/or bumpy or dirt roads.
  - If there is interference by other radar sources.
  - When your vehicle's position or movement is changed quickly or significantly (for example, lane change, turning vehicle, abrupt steering, sudden acceleration or deceleration).
  - When your vehicle or the vehicle ahead moves quickly or significantly such that the system cannot detect and react in time (for example, vehicle cutting in, changing lanes, making a turn, steering abruptly, sudden acceleration or deceleration).

- When the vehicle is offset from the vehicle's forward path.
- If the speed difference between the two vehicles is small.
- For approximately 15 seconds after starting the engine.
- If the vehicle ahead has a unique or unusual shape, extremely low or high clearance heights, or unusual cargo loading or is narrow (for example, a motorcycle).
- The system performance may be degraded in the following conditions:
  - The vehicle is driven on a slippery road.
  - The vehicle is driven on a slope.
  - Excessively heavy baggage is loaded in the rear seat or the trunk.
- The system is designed to automatically check the sensor's functionality, within certain limitations. The system may not detect some forms of obstruction of the sensor area such as ice, snow, stickers, for example. In these cases, the system may not be able to warn the driver properly. Be sure that you check, clean and clear the sensor area regularly.
- In some road or traffic conditions, the Intelligent Emergency Braking system may unexpectedly apply partial braking. When acceleration is necessary, continue to depress the accelerator pedal to override the system.
- The system may keep operating when the vehicle ahead is turning right or left.
- The system may operate when your vehicle is approaching and passing a vehicle ahead.

- Depending on the road shape (curved road, entrance and exit of the curve, winding road, lane regulation, under construction, etc.), the system may operate temporarily for the oncoming vehicle in front of your vehicle.
- The Intelligent Emergency Braking system may react to:
  - objects on the roadside (traffic sign, guardrail, vehicle, etc.)

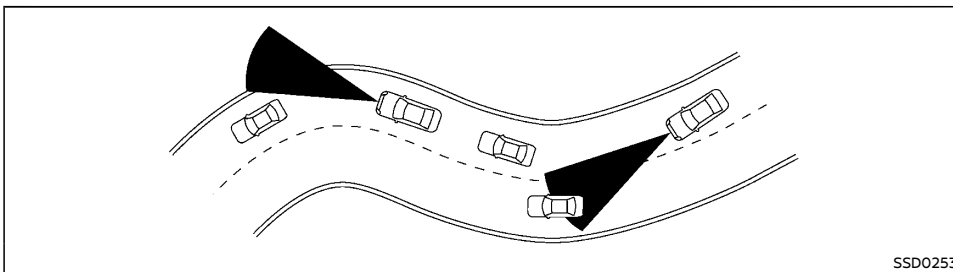

SSD0253

When driving on some roads, such as winding, hilly, curved, narrow roads, or roads which are under construction, the sensor may detect vehicles in a different lane, or may temporarily not detect a vehicle traveling ahead. This may cause the system to work inappropriately.

The detection of vehicles may also be affected by vehicle operation (steering maneuver or traveling position in the lane, etc.) or vehicle condition. **If this occurs, the system may warn you by blinking the system indicator and sounding the chime unexpectedly. You will have to manually control the proper distance away from the vehicle traveling ahead.**

### SYSTEM TEMPORARILY UNAVAILABLE

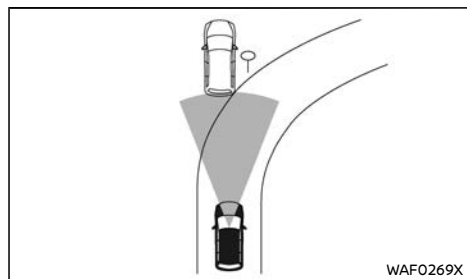

WAF0269X

- objects above road (low bridge, traffic sign, etc.)
- objects on the road surface (railroad track, grate, steel plate, etc.)
- objects in the parking garage (beam, pillar, etc.)
- vehicles or objects in adjacent lane or close to the vehicle
- objects on the road (such as trees)
- Braking distances increase on slippery surfaces.
- Excessive noise will interfere with the warning chime sound, and the chime may not be heard.

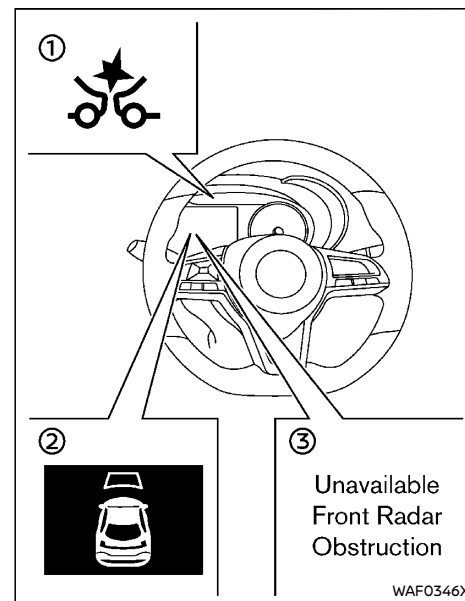

WAF0346X

- ① The Intelligent Emergency Braking system warning light (orange)
- ② The Intelligent Emergency Braking system indicator (if equipped)
- ③ Warning message (if equipped)

#### Condition A

When the radar sensor picks up interference from another radar source, making it impossible to detect a vehicle ahead, the Intelligent Emergency Braking system is automatically turned off.

The Intelligent Emergency Braking system warning light (orange) and the Intelligent Emergency Braking system indicator (if equipped) will illuminate.

#### Action to take

When the above conditions no longer exist, the Intelligent Emergency Braking system will resume automatically.

#### Condition B

In the following condition, the Intelligent Emergency Braking system warning light (orange) and the Intelligent Emergency Braking system indicator (if equipped) will illuminate, and the "Unavailable: Front Radar Obstruction" warning message (if equipped) will appear in the vehicle information display.

- The sensor area on the front of the vehicle is covered with dirt or is obstructed.

#### Action to take

If the warning light (orange) comes on, stop the vehicle in a safe place and turn the engine off. Clean the radar cover on the front of the vehicle with a soft cloth, and restart the engine. If the warning light continues to illuminate, have the Intelligent Emergency Braking system checked by a NISSAN dealer.

- When driving on roads with limited road structures or buildings (for example, long bridges, deserts, snow fields, driving next to long walls).

#### Action to take

When the above conditions no longer exist, the Intelligent Emergency Braking system will resume automatically.

#### Condition C

When Vehicle Dynamic Control (VDC) system is OFF, the Intelligent Emergency Braking system will not operate. In this case only visible and audible warning operates. The Intelligent Emergency Braking system warning light (orange) and the Intelligent Emergency Braking system indicator (if equipped) will illuminate.

#### Action to take

When the VDC system is ON, the Intelligent Emergency Braking system will resume automatically.

### SYSTEM MALFUNCTION

If the Intelligent Emergency Braking system malfunctions, it will be turned off automatically, a chime will sound, the Intelligent Emergency Braking system warning light (orange) will illuminate and the "Malfunction: See Owner's Manual" warning message (if equipped) will appear in the vehicle information display.

#### Action to take:

If the Intelligent Emergency Braking system warning light (orange) comes on, stop the vehicle in a safe location. Turn the engine off and restart the engine. If the warning light continues to illuminate, have the Intelligent Emergency Braking system checked by a NISSAN dealer.

### SYSTEM MAINTENANCE

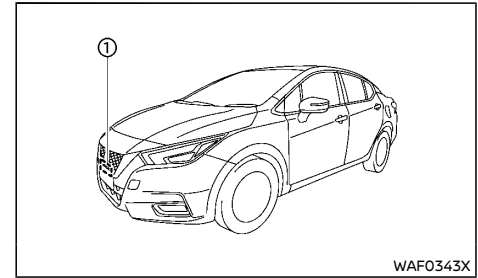

The sensor ① is located on the front of the vehicle.

To keep the system operating properly, be sure to observe the following:

- Always keep the sensor area on the front of the vehicle clean.
- Do not strike or damage the areas around the sensor.
- Do not cover or attach stickers or similar objects on the front of the vehicle near the sensor area. This could cause failure or malfunction.
- Do not attach metallic objects near the sensor area (brush guard, etc.). This could cause failure or malfunction.
- Do not alter, remove or paint the front of the vehicle near the sensor area. Contact a NISSAN dealer before customizing or restoring the sensor area.

For the radio approval numbers and information, see "Radio approval number and information" (P.9-8).

## FUEL EFFICIENCY AND CARBON DIOXIDE REDUCTION DRIVING TIPS

Follow these easy-to-use Fuel Efficiency and Carbon Dioxide Reduction Driving Tips to help you achieve the most fuel economy from your vehicle and reduce carbon dioxide emissions.

1. Use smooth accelerator and brake pedal application.
  - Avoid rapid starts and stops.
  - Use smooth, gentle accelerator and brake application whenever possible.
  - Maintain constant speed while commuting and coast whenever possible.
2. Maintain constant speed.
  - Look ahead to try and anticipate and minimize stops.
  - Synchronizing your speed with traffic lights allows you to reduce your number of stops.
  - Maintaining a steady speed can minimize red light stops and improve fuel efficiency.
3. Drive at economical speeds and distances.
  - Observing the speed limit and not exceeding 97 km/h (60 MPH) (where legally allowed) can improve fuel efficiency due to reduced aerodynamic drag.
  - Maintaining a safe following distance behind other vehicles reduces unnecessary braking.
  - Safely monitoring traffic to anticipate changes in speed permits reduced braking and smooth acceleration changes.
  - Select a gear range suitable to road conditions.
4. Use cruise control.
  - Using cruise control during highway driving helps maintain a steady speed.

- Cruise control is particularly effective in providing fuel savings when driving on flat terrains.
5. Plan for the shortest route.
    - Utilize a map or navigation system (if equipped) to determine the best route to save time.
  6. Avoid idling.
    - Shutting off your engine when safe for stops exceeding 30-60 seconds saves fuel and reduces emissions.
  7. Buy an automated pass for toll roads.
    - Automated passes permit drivers to use special lanes to maintain cruising speed through the toll and avoid stopping and starting.
  8. Winter warm up.
    - Limit idling time to minimize impact to fuel economy.
    - Vehicles typically need no more than 30 seconds of idling at start-up to effectively circulate the engine oil before driving.
    - Your vehicle will reach its ideal operating temperature more quickly while driving versus idling.
  9. Keeping your vehicle cool.
    - Park your vehicle in a covered parking area or in the shade whenever possible.
    - When entering a hot vehicle, opening the windows will help to reduce the inside temperature faster, resulting in reduced demand on your A/C system.
  10. Do not carry excessive weight.
    - Remove unnecessary objects from the vehicle to reduce vehicle weight.

## INCREASING FUEL ECONOMY AND REDUCING CARBON DIOXIDE EMISSIONS

- Keep your engine tuned up.
- Follow the recommended scheduled maintenance.
- Keep the tires inflated to the correct pressure. Low tire pressure increases tire wear and lowers fuel economy.
- Keep the wheels in correct alignment. Improper alignment increases tire wear and lowers fuel economy.
- Use the recommended viscosity engine oil. (See "Recommended fluids/lubricants and capacities" (P.9-2).)

## PARKING



### WARNING:

- Do not stop or park the vehicle over flammable materials such as dry grass, waste paper or rags. They may ignite and cause a fire.
- Safe parking procedures require that both the parking brake be applied and the shift lever placed in the “P” (Park) position (Continuously Variable Transmission (CVT) model) or the shift lever placed in an appropriate gear (Manual Transmission model). Failure to do so could cause the vehicle to move unexpectedly or roll away and result in an accident.
- When parking the vehicle, make sure the shift lever is moved to the “P” (Park) position. The shift lever cannot be moved out of the “P” (Park) position without depressing the foot brake pedal (CVT model).
- Never leave the engine running while the vehicle is unattended.
- When parking for an extended period of time with Idling Stop System (if equipped) activated, the engine will restart automatically. Never leave the vehicle with the ignition switch in the “ON” position.
- Do not leave children unattended inside the vehicle. They could unknowingly activate switches or controls. Unattended children could become involved in serious accidents.
- To help avoid risk of injury or death through unintended operation of the vehicle and/or its systems, do not leave children, people who require the assistance of others or pets unattended in

your vehicle. Additionally, the temperature inside a closed vehicle on a warm day can quickly become high enough to cause a significant risk of injury or death to people and pets.

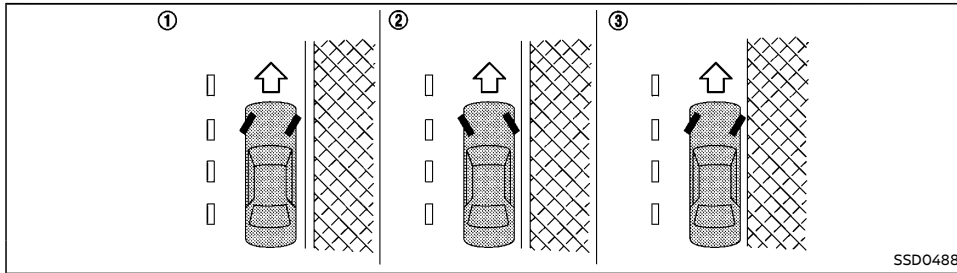

Left-Hand Drive (LHD) model

SSD0488

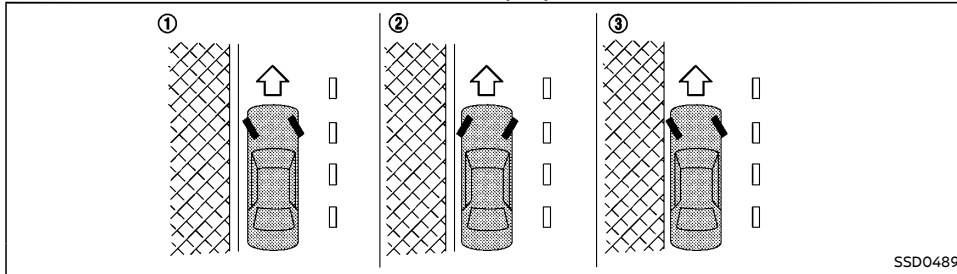

Right-Hand Drive (RHD) model

SSD0489

1. Firmly apply the parking brake.
2. Continuously Variable Transmission (CVT) model: Move the shift lever to the "P" (Park) position.  
Manual Transmission (MT) model: Move the shift lever to the "R" (Reverse) position. When parking on an uphill grade, move the shift lever to the "1" (1st) position.
3. To help prevent the vehicle from moving into traffic when parked on an incline, it is a good practice to turn the wheels as illustrated.

**HEADED DOWNHILL WITH CURB ①**

Turn the wheels into the curb and move the vehicle forward until the curb side wheel gently touches the curb. Then apply the parking brake.

**HEADED UPHILL WITH CURB ②**

Turn the wheels away from the curb and allow the vehicle to move back until the curb side wheel gently touches the curb. Then apply the parking brake.

**HEADED UPHILL OR DOWNHILL, WITHOUT CURB ③**

Turn the wheels toward the side of the

road so the vehicle will move away from the center of the road if the vehicle moves. Then apply the parking brake.

**4. Model with Intelligent Key system:**

Place the ignition switch in the "OFF" position.

**Model without Intelligent Key system:**

Place the ignition switch in the "LOCK" position and remove the key.

**NOTE:**

**For model with Idling Stop System:**

**Use the Idling Stop System when the vehicle is stopped for a period of time, for example waiting at stoplights.**

**Stop the engine with the ignition switch when parking, etc. for an extended period of time.**

## TRAILER TOWING

Your vehicle was designed to be used to carry passengers and luggage. NISSAN does not recommend trailer towing, because it places additional loads on your vehicle's engine, drive-train, steering, braking, and other systems.



### CAUTION:

**Vehicle damage resulting from towing a trailer is not covered by the warranty.**

## ELECTRIC POWER STEERING



### WARNING:

- **If the engine is not running or is turned off while driving, the power assist for the steering will not work. The steering will be harder to operate.**
- **When the electric power steering warning light illuminates with the engine running, the power assist for the steering will cease operation. You will still have control of the vehicle but the steering will be harder to operate.**

The electric power steering is designed to provide power assist while driving to operate the steering wheel with light force.

When the steering wheel is operated repeatedly or continuously while parking or driving at a very low speed, the power assist for the steering wheel will be reduced. This is to prevent overheating of the electric power steering and protect it from getting damaged. While the power assist is reduced, steering wheel operation will become heavy. When the temperature of the electric power steering goes down, the power assist level will return to normal. Avoid repeating such steering wheel operations that could cause the electric power steering to overheat.

You may hear a fricative sound when the steering wheel is operated quickly. However, this is not a malfunction.

If the electric power steering warning light  illuminates while the engine is running, it may indicate the electric power steering is not functioning properly and may need servicing. Have the electric power steering checked by a NISSAN dealer. (See "Electric power steering warning light" (P.2-14).)

When the electric power steering warning light

illuminates with the engine running, the power assist for the steering will cease operation. You will still have control of the vehicle. However, greater steering effort is needed, especially in sharp turns and at low speeds.

## BRAKE SYSTEM

The brake system has two separate hydraulic circuits. If one circuit malfunctions, you will still have braking ability at two wheels.

### BRAKE PRECAUTIONS

#### Vacuum assisted brakes

The brake booster aids braking by using engine vacuum. If the engine stops, you can stop the vehicle by depressing the foot brake pedal. However, greater foot pressure on the foot brake pedal will be required to stop the vehicle. The stopping distance will be longer.

If the engine is not running or is turned off while driving, the power assisted brakes will not function. Braking will be harder.



#### **WARNING:**

**Do not coast with the engine stopped.**

When the brake pedal is depressed slowly and firmly, you may hear a clicking noise and feel a slight pulsation. This is normal and indicates that the Brake Assist System is operating.

#### Using brakes

Avoid resting your foot on the foot brake pedal while driving. This will overheat the brakes, wear out the brake linings/pads faster, and increase fuel consumption.

To help reduce brake wear and to prevent the brakes from overheating, reduce speed and downshift to a lower gear before going down a slope or long grade. Overheated brakes may reduce braking performance and could result in loss of vehicle control.

While driving on a slippery surface, be careful when braking, accelerating or downshifting. Abrupt braking or acceleration could cause the wheels to skid and result in an accident.

### 5-40 Starting and driving

#### Wet brakes

When the vehicle is washed or driven through water, the brakes may get wet. As a result, your braking distance will be longer and the vehicle may pull to one side during braking.

To dry the brakes, drive the vehicle at a safe speed while lightly depressing the foot brake pedal to heat up the brakes. Do this until the brakes return to normal. Avoid driving the vehicle at high speeds until the brakes function correctly.

#### Driving uphill

When starting on a steep grade, it is sometimes difficult to operate both the brake and clutch (for Manual Transmission model). Apply the parking brake to hold the vehicle. Do not slip the clutch. When ready to start, slowly release the parking brake while depressing the accelerator pedal and releasing the clutch pedal.

#### Driving downhill

The engine braking action is effective for controlling the vehicle while descending hills. For Manual Transmission (MT) model, the shift lever should be placed in the lower speed position prior to descending. For Continuously Variable Transmission (CVT) model, the "L" position should be selected.

#### BRAKE ASSIST

When the force applied to the brake pedal exceeds a certain level, the Brake Assist is activated, generating greater braking force than a conventional brake booster even with light pedal force.



#### **WARNING:**

**The Brake Assist is only an aid to assist braking operation and is not a collision warning or avoidance device. It is the driver's responsibility to stay alert, drive safely and be in control of the vehicle at all times.**



## ANTI-LOCK BRAKING SYSTEM (ABS)



### WARNING:

- **The Anti-lock Braking System (ABS) is a sophisticated device, but it cannot prevent accidents resulting from careless or dangerous driving techniques. It can help maintain vehicle control during braking on slippery surfaces. Remember that stopping distances on slippery surfaces will be longer than on normal surfaces even with ABS. Stopping distances may also be longer on rough, gravel or snow covered roads, or if you are using tire chains. Always maintain a safe distance from the vehicle in front of you. Ultimately, the driver is responsible for safety.**
- **Tire type and condition may also affect braking effectiveness.**
  - **When replacing tires, install the specified size of tires on all four wheels.**
  - **When installing a spare tire (if equipped), make sure that it is the proper size and type as specified on the tire placard. (See “Tire placard” (P.9-6).)**
  - **For detailed information, see “Tires and wheels” (P.8-23).**

The Anti-lock Braking System (ABS) controls the brakes so the wheels do not lock during hard braking or when braking on slippery surfaces. The system detects the rotation speed at each wheel and varies the brake fluid pressure to prevent each wheel from locking and sliding. By preventing each wheel from locking, the system helps the driver maintain steering control and helps to minimize swerving and spinning on slippery surfaces.

### USING SYSTEM

Depress the brake pedal and hold it down. Depress the brake pedal with firm steady pressure, but do not pump the brakes. The ABS will operate to prevent the wheels from locking up. Steer the vehicle to avoid obstacles.



### WARNING:

**Do not pump the brake pedal. Doing so may result in increased stopping distances.**

### SELF-TEST FEATURE

The ABS includes electronic sensors, electric pumps, hydraulic solenoids and a computer. The computer has a built-in diagnostic feature that tests the system each time you start the engine and move the vehicle at a low speed in forward or reverse. When the self-test occurs, you may hear a “clunk” noise and/or feel a pulsation in the brake pedal. This is normal and does not indicate a malfunction. If the computer senses a malfunction, it switches the ABS off and illuminates the ABS warning light on the instrument panel. The brake system then operates normally, but without anti-lock assistance.

If the ABS warning light illuminates during the self-test or while driving, have the vehicle checked by a NISSAN dealer.

### NORMAL OPERATION

The ABS operates at speeds above 5 to 10 km/h (3 to 6 MPH). The speed varies according to road conditions.

When the ABS senses that one or more wheels are close to locking up, the actuator rapidly applies and releases hydraulic pressure. This action is similar to pumping the brakes very quickly. You may feel a pulsation in the brake pedal and hear a noise from under the hood or feel a vibration from the actuator when it is operating. This is normal and indicates that the ABS is operating properly. However, the pulsation may indicate that road conditions are hazardous and extra care is required while driving.

## VEHICLE SECURITY

When leaving your vehicle unoccupied:

- Always take the key with you - even when leaving the vehicle in your own garage.
- Close all windows completely and lock all doors.
- Always park your vehicle where it can be seen. Park in a well lit area during the night.
- If the security system is equipped, use it - even for a short period.
- Never leave children or pets in the vehicle unattended.
- Never leave valuables inside the vehicle. Always take valuables with you.
- Never leave the vehicle documents in the vehicle.
- Never leave articles on a roof rack. Remove them from the rack and keep and lock them inside the vehicle.
- Never leave the spare key in the vehicle.

## COLD WEATHER DRIVING



### WARNING:

- **Whatever the condition, drive with caution. Accelerate and decelerate with great care. If accelerating or decelerating too fast, the drive wheels will lose even more traction.**
- **Allow more stopping distance in cold weather driving. Braking should be started sooner than on dry pavement.**
- **Keep at a greater distance from the vehicle in front of you on slippery roads.**
- **Wet ice (0°C, 32°F and freezing rain), very cold snow and ice can be slick and very difficult to drive on. The vehicle will have a lot less traction or grip under these conditions. Try to avoid driving on wet ice until the road is salted or sanded.**
- **Watch for slippery spots (glaring ice). These may appear on an otherwise clear road in shaded areas. If a patch of ice is seen ahead, brake before reaching it. Try not to brake while actually on the ice, and avoid any sudden steering maneuvers.**
- **Do not use cruise control on slippery roads.**
- **Snow can trap dangerous exhaust gas under your vehicle. Keep snow clear of the exhaust pipe and from around your vehicle.**

## BATTERY

If the battery is not fully charged during extremely cold weather conditions, the battery fluid may freeze and damage the battery. To maintain maximum efficiency, the battery should be checked regularly. For details, see "Battery" (P.8-14).

## ENGINE COOLANT

If the vehicle is to be left outside without anti-freeze, drain the cooling system, including the engine block. Refill before operating the vehicle. For details, see "Changing engine coolant" (P.8-6).

## TIRE EQUIPMENT

1. If you have snow tires installed on the front/rear wheels of your vehicle, they should be of the same size, loading range, construction and type (bias, bias-belted or radial) as the rear/front tires.
2. If the vehicle is to be operated in severe winter conditions, snow tires should be installed on all four wheels.
3. For additional traction on icy roads, studded tires may be used. However, some countries, provinces and states prohibit their use. Check local, state and provincial laws before installing studded tires.

**Skid and traction capabilities of studded snow tires, on wet or dry surfaces, may be poorer than that of non-studded snow tires.**

4. Snow chains may be used if desired. Make sure they are the proper size for the tires on your vehicle and are installed according to the chain manufacturer's instructions. (See "Tire chains" (P.8-24).)

## SPECIAL WINTER EQUIPMENT

It is recommended that the following items be carried in the vehicle during the winter:

- A scraper and stiff-bristled brush to remove ice and snow from the windows.
- A sturdy, flat board to be placed under the jack to give it firm support.
- A shovel to dig the vehicle out of snow-drifts.

## PARKING BRAKE

When parking in the area where the outside temperature is below 0°C (32°F), do not apply the parking brake to prevent it from freezing. For safe parking:

- Place the shift lever in the "P" (Park) position (Continuously Variable Transmission (CVT) model).
- Place the shift lever in the "1" (1st) or "R" (Reverse) position (Manual Transmission (MT) model).
- Securely block the wheels.

## CORROSION PROTECTION

Chemicals used for road surface deicing are extremely corrosive and will accelerate corrosion and the deterioration of underbody components such as the exhaust system, fuel and brake lines, brake cables, floor pan and fenders.

**In the winter, the underbody must be cleaned periodically. For additional information, see "Corrosion protection" (P.7-5).**

For additional protection against rust and corrosion, which may be required in some areas, consult a NISSAN dealer.

**MEMO**

# 6 In case of emergency

Hazard indicator flasher switch .....	6-2	Jump starting .....	6-10
Flat tire .....	6-2	Push starting .....	6-12
Stopping vehicle .....	6-2	If your vehicle overheats .....	6-12
Preparing tools .....	6-2	Towing your vehicle .....	6-13
Changing flat tire (for model with spare tire) .....	6-3	Towing precautions .....	6-13
Repairing flat tire (for model with emergency tire puncture repair kit) .....	6-5	Towing recommended by NISSAN .....	6-14



## HAZARD INDICATOR FLASHER SWITCH

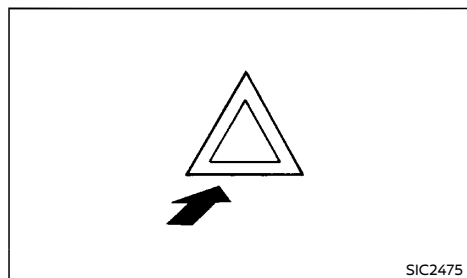

The hazard indicator flasher switch operates with the ignition switch in any position except when the battery is discharged.

The hazard indicator flasher is used to warn other drivers when you have to stop or park under emergency conditions.

When the hazard indicator flasher switch is pushed, all turn signal lights will flash. To turn off the hazard indicator flasher, push the hazard indicator flasher switch again.

When an impact that could activate the supplemental air bags is detected, the hazard warning flasher lights blink automatically.

### **WARNING:**

**Do not turn the hazard warning flasher switch to off until you can make sure that it is safe to do so. Also, the hazard flasher warning may not blink automatically depending on the force of impact.**

If the hazard warning flasher switch is pushed, the hazard warning flashers will turn off.

## FLAT TIRE

If you have a flat tire, follow the instructions as follows.

### STOPPING VEHICLE

#### **WARNING:**

- Be sure to apply the parking brake firmly.
- Be sure to move the shift lever to the "P" (Park) position (Continuously Variable Transmission (CVT) model).
- Be sure to move the shift lever to the "R" (Reverse) position (Manual Transmission (MT) model).
- Never change tires when the vehicle is on a slope, ice or slippery area. This is hazardous.
- Never change tires when the oncoming traffic is close to your vehicle. Call for professional road assistance.

1. Safely move the vehicle off the road away from traffic.
2. Turn on the hazard indicator flasher lights.
3. Park on a level surface.
4. Apply the parking brake.
5. Continuously Variable Transmission (CVT) model: Move the shift lever to the "P" (Park) position.

Manual Transmission (MT) model: Move the shift lever to the "R" (Reverse) position.

6. Turn off the engine.
7. Open the hood and set up the warning triangle (if equipped):
  - To warn other traffic.
  - To signal professional road assistance personnel that you need assistance.

8. Have all passengers get out from the vehicle and stand in a safe place, away from other traffic and clear of the vehicle.

### PREPARING TOOLS

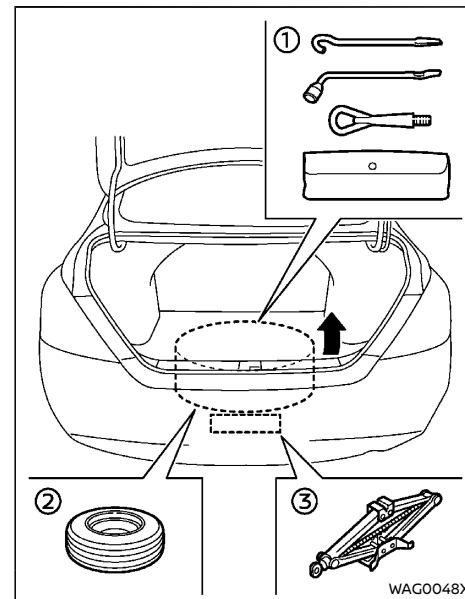

- ① Tools\*
- ② Spare tire (if equipped)
- ③ Jack (if equipped)

\*: The supplied set of tools varies depending on the models.

Your vehicle is equipped with either a spare tire or an emergency tire puncture repair kit. Care-

fully read the instructions provided in the appropriate section.

- For model with spare tire: See "Changing flat tire (for model with spare tire)" (P.6-3).
- For model with emergency tire puncture repair kit: See "Repairing flat tire (for model with emergency tire puncture repair kit)" (P.6-5).

### CHANGING FLAT TIRE (for model with spare tire)

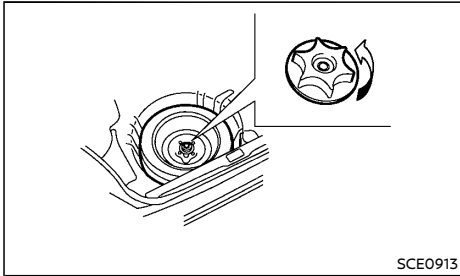

Remove the jack, necessary tools and the spare tire from the storage area.

#### **CAUTION:**

**Do not touch floor metal directly. Doing so could result in any burns.**

### Blocking wheels

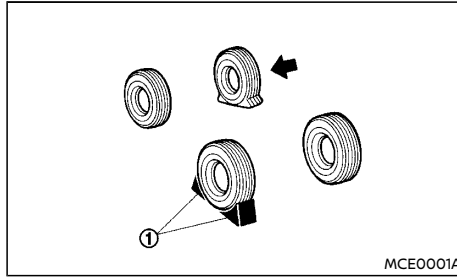

#### **WARNING:**

**Be sure to block the appropriate wheel to prevent the vehicle from moving, which may cause personal injury.**

Place suitable blocks ① at both the front and back of the wheel diagonally opposite the flat tire ← to prevent the vehicle from moving when it is jacked up.

### Removing tire

#### Removing wheel cover (if equipped):

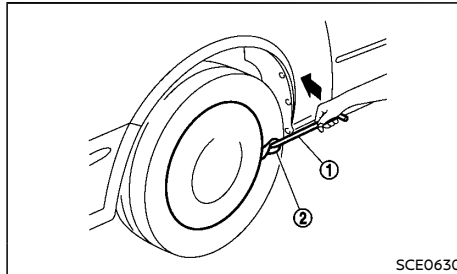

#### **WARNING:**

**Never use your hands to remove the wheel cover. This may cause personal injury.**

To remove the wheel cover, use the jack rod ① as illustrated.

Apply cloth ② between the wheel and jack rod to prevent damaging the wheel and wheel cover.

#### Jacking up vehicle:

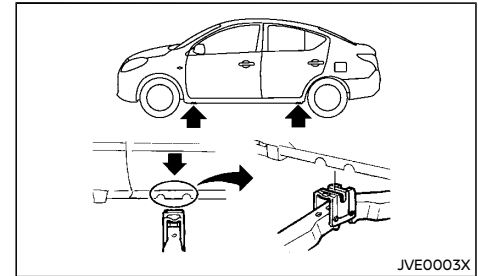

#### jack-up points

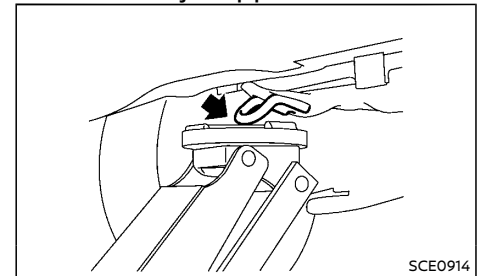

#### Floor jack-up point

For the rear, never jack up the vehicle at a location other than the floor jack-up point that

is specified.

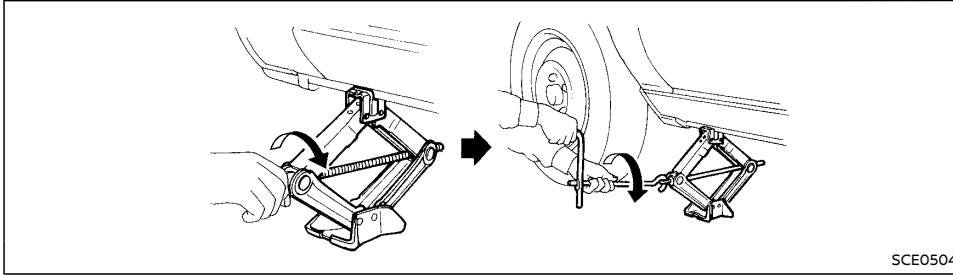

SCE0504

**WARNING:**

- Be sure to read and follow the instructions in this section.
- **DO NOT GET UNDER A VEHICLE THAT IS SUPPORTED BY A JACK.**
- Never use a jack which was not provided with your vehicle.
- The jack, which is provided with your vehicle, is designed only to lift your vehicle during a tire change. Do not use the jack provided with your vehicle on other vehicles.
- Never jack up the vehicle at a location other than the jack-up point that is specified.
- Never lift the vehicle more than necessary.
- Never use blocks on or under the jack.
- Never start or run the engine while the vehicle is on the jack. The vehicle may move suddenly, and this may cause an accident.

- Never allow passengers to remain in the vehicle while the tire is off the ground.
- Be sure to read the caution label attached to the jack body before using.
- When jacking up the vehicle, be sure to apply the parking brake.

1. Place the jack directly under the jack-up point as illustrated so that the top of the jack contacts the vehicle at the jack-up point.

**The jack should be placed on firm level ground.**

2. Align the jack head between the two notches located at the jack-up point of either the front or the rear section.
3. Fit the groove of the jack head between the notches as shown.
4. Loosen each wheel nut, counterclockwise, one or two turns with the wheel nut wrench.

**Do not remove the wheel nuts until the tire is off the ground.**

5. Carefully raise the vehicle until the clearance between the tire and ground is achieved.
6. To lift the vehicle, securely hold the jack lever and rod with both hands and turn the jack lever.

**Removing tire:**

1. Remove the wheel nuts.
2. Remove the damaged tire.



**CAUTION:**

**The tire is heavy. Be sure that your feet are clear from the tire and use gloves as necessary to avoid injury.**

Installing spare tire

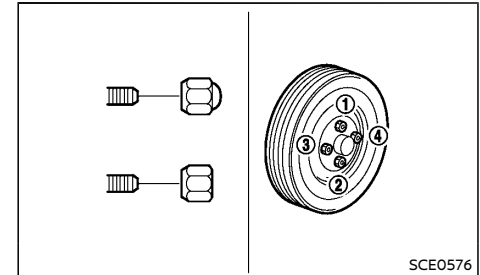

SCE0576



**WARNING:**

- Never use wheel nuts which are not provided with your vehicle. Incorrect wheel nuts or improperly tightened wheel nuts may cause the wheel to become loose or come off. This could cause an accident.



- **Never use oil or grease on the wheel studs or nuts. This may cause the wheel nuts to become loose.**

- **The temporary-use spare tire is designed for emergency use only.**

1. Clean any mud or dirt from the surface between the wheel and hub.
2. Carefully put the spare tire on and tighten the wheel nuts with your fingers. Check that all the wheel nuts contact the wheel surface horizontally.
3. Tighten the wheel nuts alternately and evenly, more than 2 times in the sequence illustrated (① - ④), with the wheel nut wrench, until they are tight.
4. Lower the vehicle slowly until the tire touches the ground.
5. Tighten the wheel nuts securely, with the wheel nut wrench, in the sequence illustrated.
6. Lower the vehicle completely.

**Tighten the wheel nuts to the specified torque with a torque wrench as soon as possible.**

**Wheel nut tightening torque:**  
108 N·m (11 kg·m, 80 ft·lb)

The wheel nuts must be kept tightened to specification at all times. It is recommended that the wheel nuts be tightened to specification at each lubrication interval.



**WARNING:**

Retighten the wheel nuts when the vehicle has been driven for 1,000 km (600 miles). (also in cases of a flat tire, etc.)

### Stowing damaged tire and tools



**WARNING:**

- **Be sure that the tire, jack and tools used are properly stored after use. Such items can become dangerous projectiles in an accident or sudden stop.**
- **The temporary-use spare tire is designed for emergency use only.**
  1. Securely store the damaged tire, jack and tools used in the storage area.
  2. Replace the floor cover.
  3. Close the trunk lid.

### REPAIRING FLAT TIRE (for model with emergency tire puncture repair kit)

The emergency tire puncture repair kit is supplied with the vehicle instead of a spare tire. This repair kit must be used for temporarily fixing a minor tire puncture. After using the repair kit, see a NISSAN dealer as soon as possible for tire inspection and repair/replacement.



**CAUTION:**

- **NISSAN recommends using only Genuine NISSAN Emergency Tire Sealant provided with your vehicle. Other tire sealants may damage the valve stem seal which can cause the tire to lose air pressure.**
- **Do not use the emergency tire puncture repair kit provided with your vehicle on other vehicles.**
- **Do not use the emergency tire puncture repair kit for a purpose other than to inflate and check the tire pressure for the vehicle.**

- **Use the emergency tire puncture repair kit only on DC12V.**
- **Keep water and dust off the emergency tire puncture repair kit.**
- **Do not disassemble or modify the emergency tire puncture repair kit.**
- **Do not galvanize the emergency tire puncture repair kit.**
- **Do not use the emergency tire puncture repair kit under the following conditions. Contact a NISSAN dealer or professional road assistance.**

– when the sealant has passed its expiration date (shown on the label attached to the bottle)

– when the cut or the puncture is approximately 4 mm (0.16 in) or longer

– when the side of the tire is damaged

– when the vehicle has been driven with a considerable loss of air from the tire

– when the tire is completely displaced inside or outside the rim

– when the tire rim is damaged

– when two or more tires are flat

### Getting emergency tire puncture repair kit

Take out the emergency tire puncture repair kit from the storage area under the trunk. The repair kit consists of the following items:

### Type A:

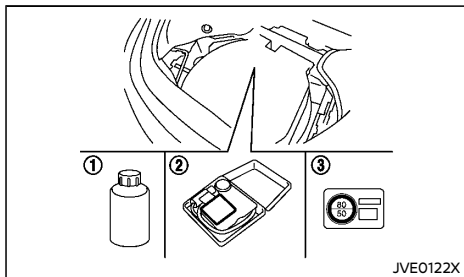

① Tire sealant bottle

② Air compressor\*

③ Speed restriction sticker\*

\*: The compressor shape and the sticker design may differ depending on the models.

### Type B:

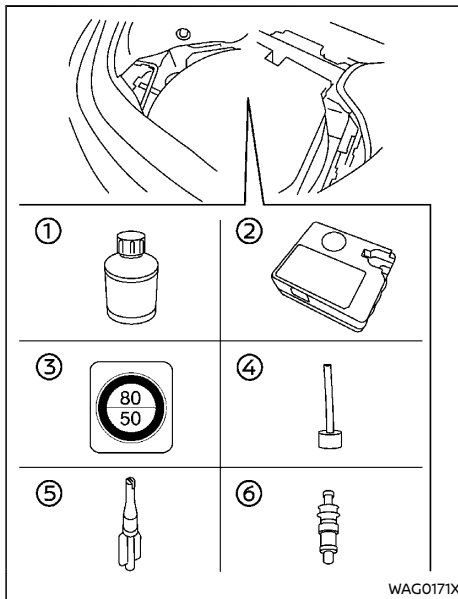

① Tire sealant bottle

② Air compressor\*

③ Speed restriction sticker\*

④ Sealant filler tube

⑤ Valve core tool

⑥ Valve core (for spare)

\*: The compressor shape and the sticker design may differ depending on the models.

Before using emergency tire puncture repair kit

- If any foreign object (for example, a screw or nail) is embedded in the tire, do not remove it.
- Check the expiration date of the sealant (shown on the label attached to the bottle). Never use a sealant whose expiration date has passed.

Repairing tire (Type A)



Observe the following precautions when using the emergency tire puncture repair kit.

- **Swallowing the compound is dangerous. Immediately drink as much water as possible and seek prompt medical assistance.**
- **Rinse well with lots of water if the compound comes into contact with skin or eyes. If irritation persists, seek prompt medical attention.**
- **Keep the repair compound out of the reach of children.**

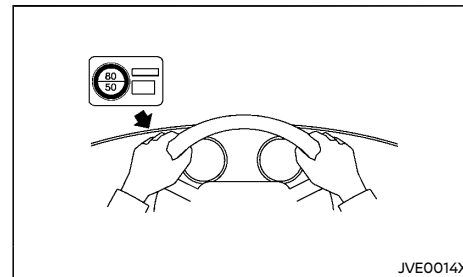

1. Take out the speed restriction sticker from the air compressor, then put it in a location where the driver can see it while driving.

**CAUTION:**

Do not put the speed restriction sticker on the steering wheel pad, the speedometer or the warning light locations.

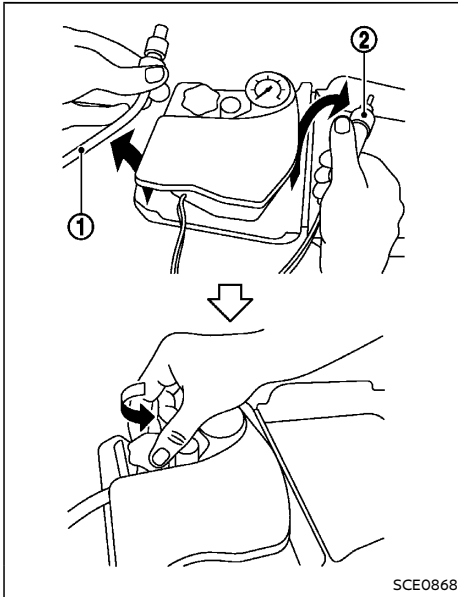

2. Take the hose ① and the power plug ② out of the air compressor. Remove the cap of the bottle holder from the air compressor.

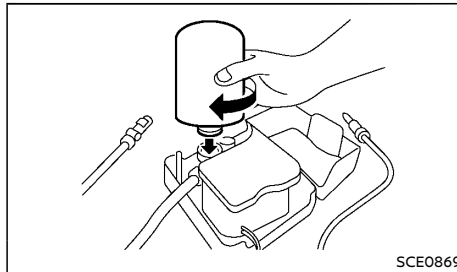

3. Remove the cap of the tire sealant bottle, and screw the bottle clockwise onto the bottle holder. (Leave the bottle seal intact. Screwing the bottle onto the bottle holder will pierce the seal of the bottle.)
4. Remove the cap of the tire valve on the flat tire.

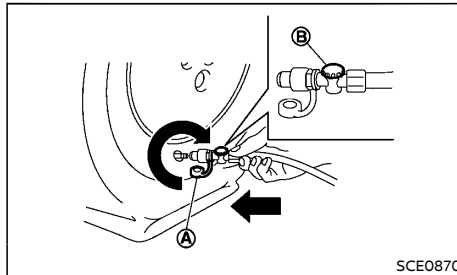

5. Remove the protective cap ① of the hose and screw the hose securely onto the tire valve. Make sure that the pressure release valve ② is securely tightened. Make sure that the air compressor switch is in the OFF (○) position, and then insert its power plug into the power outlet in the vehicle.

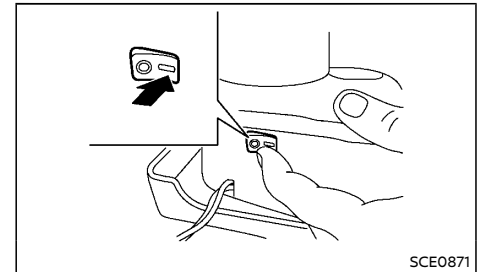

6. Place the ignition switch in the "ON" position. Then turn the compressor switch to the ON (-) position and inflate the tire up to the pressure that is specified on the tire placard affixed to the driver's side center pillar if possible, or to the minimum of 180 kPa (26 psi). Turn the air compressor off briefly in order to check the tire pressure with the pressure gauge. If the tire is inflated to higher than the specified pressure, adjust the tire pressure by releasing air with the pressure release valve. The cold tire pressures are shown on the tire placard affixed to the driver's side center pillar.

**CAUTION:**

- An incomplete connection between the hose and tire valve causes air leakage or sealant scatter.
- Do not stand directly beside the damaged tire while it is being inflated because of the risk of the rupture. If there are any cracks or bumps, turn the compressor off immediately.
- There is a possibility that the pressure reaches 600 kPa (87 psi) while the tire is being inflated, but it is normal condition.

Usually the pressure will drop in about 30 seconds.

- **Do not operate the compressor for more than 10 minutes. If the tire pressure does not increase to 180 kPa (26 psi) within 10 minutes, the tire may be seriously damaged and the tire cannot be repaired with this tire repair kit. Contact a NISSAN dealer.**
7. When the tire pressure is reaching the specified pressure or is at the minimum of 180 kPa (26 psi), turn the air compressor off. Remove the power plug from the power outlet and quickly remove the hose from the tire valve. Attach the protective cap and valve cap.



**CAUTION:**

**Leave the tire sealant bottle on the bottle holder in order to prevent sealant from spilling out.**

8. Immediately drive the vehicle for 10 minutes or 3 km (2 miles) at a speed of 80 km/h (50 MPH) or less.
9. After driving, make sure that the air compressor switch is in the OFF (○) position, then screw the hose securely onto the tire valve. Check the tire pressure with the pressure gauge.

**If the tire pressure drops under 130 kPa (19 psi):**

**The tire cannot be repaired with this tire puncture repair kit. Contact a NISSAN dealer.**

**If the tire pressure is 130 kPa (19 psi) or more but less than the specified pressure:**

Turn the compressor switch to the ON (-) position and inflate the tire up to the specified pressure. Then repeat the steps from 8.

If the pressure drops again, **the tire cannot be repaired with this tire puncture repair kit. Contact a NISSAN dealer.**

**When the tire pressure is the specified pressure:**

The temporary repair is completed.

See a NISSAN dealer for tire repair/replacement as soon as possible.



**CAUTION:**

**Do not reuse the tire sealant bottle or the hose.**

**For a new tire sealant bottle and hose, see a NISSAN dealer.**

Repairing tire (Type B)



**WARNING:**

**Observe the following precautions when using the emergency tire puncture repair kit.**

- **Swallowing the compound is dangerous. Immediately drink as much water as possible and seek prompt medical assistance.**
- **Rinse well with lots of water if the compound comes into contact with skin or eyes. If irritation persists, seek prompt medical attention.**
- **Keep the repair compound out of the reach of children.**

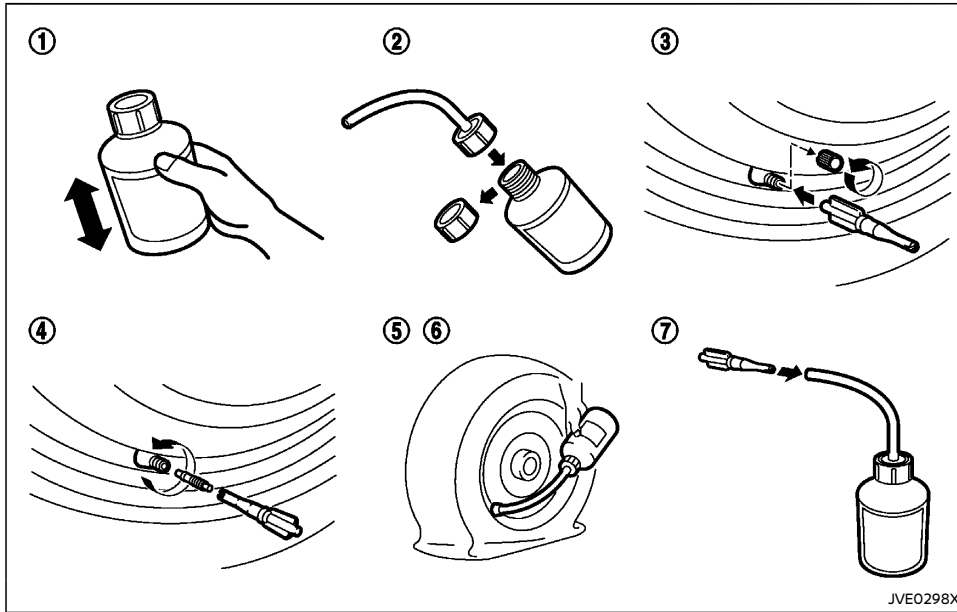

1. Shake the sealant bottle well.
2. Remove the cap on the bottle and screw the sealant filler tube into the bottle.
3. Remove the cap of the valve on the flat tire, and deflate the tire completely by pushing the valve core using the valve core tool.
4. Remove the valve core carefully using the valve core tool. Keep it free of dirt.
5. Insert the tube into the tire valve.
6. Hold the bottle upside down and squeeze it repeatedly until the sealant is injected into the tire. After the sealant is completely injected, pull the tube out of the valve. Install the tire valve core securely into the valve using the valve core tool.
7. Firmly screw the tire valve core tool into the end of the tube to prevent the sealant from

**Do not throw away the empty sealant bottle. This bottle is necessary when the tire is repaired or replaced by a NISSAN dealer.**

leaking out of the empty sealant bottle.

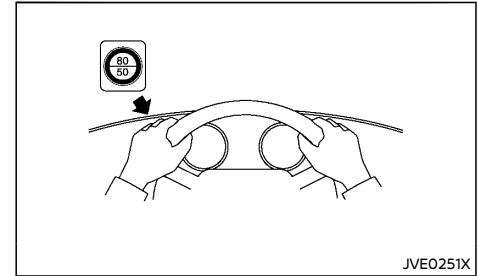

8. Put the speed restriction sticker in a location where the driver can see it while driving.



**CAUTION:**

**Do not put the speed restriction label on the steering wheel pad, the speedometer or the warning light locations.**

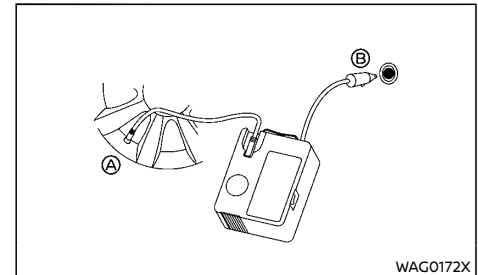

9. Screw the tube of the air compressor securely into the tire valve (A). Insert its power plug to the power outlet (B) in the vehicle. Place the ignition switch in the "ON"

position. Then turn on the compressor, and inflate the tire to the pressure that is specified on the tire placard affixed to the driver's side center pillar.



#### CAUTION:

**Do not operate the compressor for more than 15 minutes.**

If the tire pressure does not increase to the specified pressure or to the minimum of 180 kPa (26 psi) **within 15 minutes**, the tire may be seriously damaged and **the tire cannot be repaired with this tire puncture repair kit**. Contact a NISSAN dealer.

10. When the tire pressure is at the specified amount or at the minimum of 180 kPa (26 psi), remove the air compressor from the tire valve. Immediately drive the vehicle at a speed of 80 km/h (50 MPH) or less.
11. After a 10-minute or 5-km (3 mile) drive, check the tire pressure with the pressure gauge of the air compressor. Make sure that the air compressor switch is in the OFF position.

**If the tire pressure drops under 130 kPa (19 psi):**

**The tire cannot be repaired with this tire puncture repair kit.** Contact a NISSAN dealer.

**If the tire pressure is 130 kPa (19 psi) or more but less than the specified pressure:**

Turn on the compressor and inflate the tire up to the specified pressure. Then repeat the steps from 9.

If the pressure drops again, **the tire cannot be repaired with this tire puncture repair kit**. Contact a NISSAN dealer.

**When the tire pressure is the specified pressure:**

The temporary repair is completed.

See a NISSAN dealer for tire repair/replacement as soon as possible.



#### CAUTION:

**Do not reuse the tire sealant bottle or the hose.**

**For a new tire sealant bottle and hose, see a NISSAN dealer.**

After repairing tire

See a NISSAN dealer for tire repair/replacement as soon as possible.

## JUMP STARTING



#### WARNING:

- **Incorrect jump starting can lead to a battery explosion. The battery explosion may result in severe injury or death. It may also result in damage to the vehicle. Be sure to follow the instructions in this section.**
- **Explosive hydrogen gas is always present in the vicinity of the battery. Keep all sparks and flames away from the battery.**
- **Always wear suitable eye protection and remove rings, bracelets, and any other jewelry whenever working on or near a battery.**
- **Never lean over the battery while jump starting.**
- **Never allow battery fluid to come into contact with eyes, skin, clothes or the vehicle's painted surfaces. Battery fluid is a corrosive sulfuric acid which can cause severe burns. If the fluid comes into contact with anything, immediately flush the contacted area with plenty of water.**
- **Keep the battery out of the reach of children.**
- **The booster battery must be rated at 12 volts. Use of an incorrectly rated battery will damage your vehicle.**
- **Never attempt to jump start a frozen battery. It could explode and cause serious injury.**

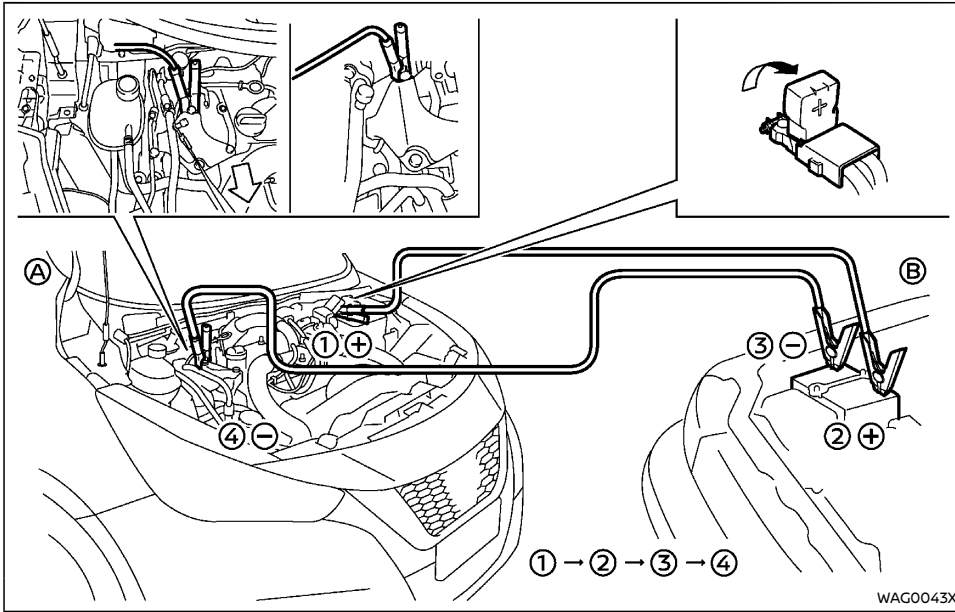

1. If the booster battery is in another vehicle **B**, position the two vehicles **A** and **B** to bring the batteries into close proximity to each other.



**CAUTION:**

If the battery of vehicle **A** equipped with the Intelligent Key system is discharged, the ignition switch cannot be moved from the "LOCK" position and, if the steering lock is engaged, the steering wheel cannot be moved. Connect the jumper cables to the

**booster vehicle **B** before pushing the ignition switch and disengaging the steering lock.**

2. Apply the parking brake.
3. Continuously Variable Transmission (CVT) model: Move the shift lever to the "P" (Park) position.  
Manual Transmission (MT) model: Move the shift lever to the "N" (Neutral) position.
4. Switch off all unnecessary electrical systems (headlights, heater, air conditioner, etc.).

5. Place the ignition switch in the "LOCK" position.
6. Remove the vent caps, if equipped, on the battery.
7. Cover the battery with a firmly wrung out moist cloth to reduce the hazard of an explosion.
8. Connect the jumper cables in the sequence as illustrated (1, 2, 3, 4).



**CAUTION:**

- Always connect positive  $\oplus$  to positive  $\oplus$  and negative  $\ominus$  to body ground, NOT to the battery's negative  $\ominus$ .
  - Be sure that the jumper cables do not touch moving parts in the engine compartment.
  - Be sure that the jumper cable's clamps do not contact any other metal.
9. Start the engine of the booster vehicle **B** and let it run for a few minutes.
  10. Depress the accelerator pedal of the booster vehicle **B** at about 2,000 rpm.
  11. Start the engine of the jumped vehicle **A** in the normal manner.



**CAUTION:**

- Never keep the starter motor engaged for more than 10 seconds. If the engine does not start right away, place the ignition switch in the "OFF" position and wait at least 10 seconds before trying again.
- If the starter motor does not start by turning or pushing the ignition switch, place the ignition switch in the "OFF" position before trying again.

## PUSH STARTING

Do not attempt to start the engine by pushing the vehicle.



### CAUTION:

- **Continuously Variable Transmission (CVT)/Manual Transmission (MT) model cannot be started by pushing. Attempting to do so may cause damage to the transmission.**
- **Three-way catalyst equipped model should not be started by pushing. Attempting to do so may cause damage to the three-way catalyst.**
- **Never try to start the engine by towing. When the engine starts, the forward surge could cause the vehicle to collide with the towing vehicle.**

12. After the engine is started, carefully disconnect the jumper cables in the opposite sequence from that illustrated (④, ③, ②, ①).
13. Remove and dispose of the cloth as it may be contaminated with corrosive acid.
14. Replace the vent caps, if removed.

### NOTE:

- **Use the special battery that is enhanced in regard to the charge-discharge capacity and life performance. Avoid using a non-special battery for the Idling Stop system (if equipped), as this may cause early deterioration of the battery or a malfunction of the Idling Stop system. For the battery, it is recommended to use Genuine NISSAN parts. For more information, contact a NISSAN dealer.**
- **It may take some time until the Idling Stop System (if equipped) activates when the battery is replaced or the battery terminal is disconnected for extended periods and then reconnected.**

## IF YOUR VEHICLE OVERHEATS



### WARNING:

- **Never continue driving if your vehicle overheats. Doing so could cause a vehicle fire.**
- **Never open the hood if steam is coming out.**
- **Never remove the radiator cap while the engine is hot. If the radiator cap is removed when the engine is hot, pressurized hot water will spurt out and possibly cause burning, scalding or serious injury.**
- **If steam or coolant is coming from the engine, stand clear of the vehicle to prevent getting burned.**
- **Be careful not to allow your hands, hair, jewelry or clothing to come into contact with, or to get caught in the cooling fan or drive belts. The engine cooling fan will start at any time.**

If your vehicle is overheating (indicated by the high temperature indicator), or if you feel a lack of engine power, detect unusual noise, etc., take the following steps:

1. Safely move the vehicle off the road away from traffic.
2. Turn on the hazard indicator flasher lights.
3. Apply the parking brake.
4. Continuously Variable Transmission (CVT) model: Move the shift lever to the "P" (Park) position.

Manual Transmission (MT) model: Move the shift lever to the "N" (Neutral) position.

**DO NOT STOP THE ENGINE.**



## TOWING YOUR VEHICLE

5. Open all windows.
6. Turn off the air conditioner. Set the temperature control to maximum hot and fan control to maximum speed.
7. Get out from the vehicle.
8. Visually inspect and listen for steam or coolant escaping from the radiator before opening the hood. Wait until no steam or coolant can be seen before proceeding.
9. Open the engine hood.
10. Visually inspect if the cooling fan is running.
11. Visually inspect the radiator and radiator hoses for leakage.  
If the cooling fan is not running or the coolant is leaking, stop the engine.
12. After the engine cools down, check the coolant level in the reservoir with the engine running. **Do not open the radiator cap.**
13. Add coolant to the reservoir if necessary.

Have your vehicle inspected/repared at a NISSAN dealer.

When towing your vehicle, local regulations for towing must be followed. Incorrect towing equipment could damage your vehicle. To assure proper towing and to prevent accidental damage to your vehicle, NISSAN recommends that you have professional road assistance personnel tow your vehicle. It is advisable to have the professional road assistant carefully read the following precautions.

### TOWING PRECAUTIONS

- Be sure that the transmission, steering system and powertrain are in working condition before towing. If any units are damaged, the vehicle must be towed using a dolly or flatbed tow truck.
- NISSAN recommends that your vehicle be towed with the driving (front) wheels off the ground.
- Always attach safety chains before towing.

## TOWING RECOMMENDED BY NISSAN

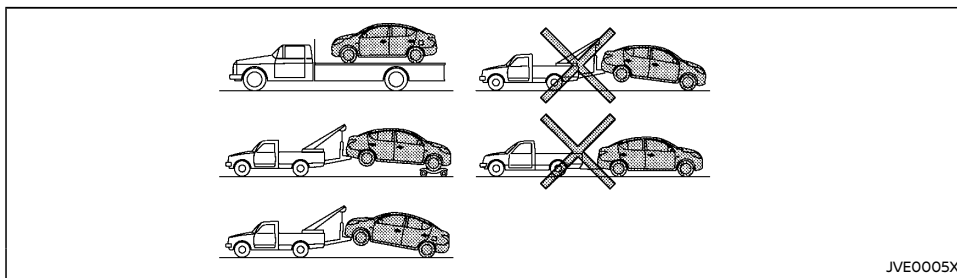

NISSAN recommends that towing dollies be used under the front wheels when towing your vehicle or the vehicle be placed on a flatbed tow truck as illustrated.

### Front wheels on the ground:



#### CAUTION:

**Never tow Continuously Variable Transmission (CVT) model with the front wheels on the ground. Doing so will cause serious and expensive damage to the drivetrain.**

Manual Transmission (MT) model:

1. Place the ignition switch in the "OFF" position.
2. Secure the steering wheel in a straight ahead position with rope or a similar device.
3. Move the shift lever to the "N" (Neutral) position.
4. Release the parking brake.
5. Attach safety chains whenever towing.

### Rear wheels on the ground:

1. Place the ignition switch in the "OFF" position.
2. Secure the steering wheel in a straight-ahead position with rope or a similar device.
3. Move the shift lever to the "N" (Neutral) position.
4. Release the parking brake.
5. Attach safety chains whenever towing.

### All four wheels on the ground:

NISSAN recommends that the vehicle be placed on a flatbed tow truck as illustrated.



#### CAUTION:

**Never tow Continuously Variable Transmission (CVT) model with all four wheels on the ground. Doing so will cause serious and expensive damage to the transmission.**

Manual Transmission (MT) model:

If you have to tow a MT vehicle with all four wheels on the ground, perform the following

procedures.



#### CAUTION:

**Never tow a Manual Transmission (MT) model backward with all four wheels on the ground.**

1. Place the ignition switch in the "OFF" position.
2. Move the shift lever to the "N" (Neutral) position.
3. Release the parking brake.

Freeing trapped vehicle



#### WARNING:

- **Never allow anyone to stand near the towing line during the pulling operation.**
- **Never spin the tires at high speed. This could cause them to explode and result in serious injury. Parts of the vehicle could also overheat and be damaged.**
- **Do not pull the vehicle using the rear hook. The rear hook is not designed to pull the vehicle out in the event that the vehicle becomes trapped.**

In the event that your vehicle's tires become trapped in sand, snow, or mud, and the vehicle is unable to free itself without being pulled, use the recovery hooks.

- Use the recovery hooks only. Do not attach the pulling device to any other part of the vehicle body. Otherwise, the vehicle body may be damaged.
- Use the recovery hooks to free a vehicle only. Never tow a vehicle using only the recovery hooks.

- The recovery hooks are under tremendous stress when used to free a trapped vehicle. Always pull the pulling device straight out from the vehicle. Never pull on the recovery hooks at an angle.

**Front:**

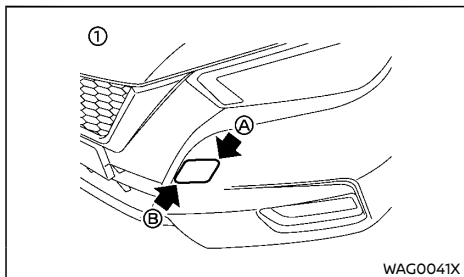

- ① Remove the hook cover from the bumper.
  - Push the edge of the cover **A**, and pull up the cover from the position **B**. If necessary, use a suitable tool.

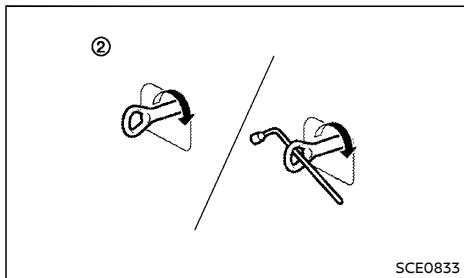

- ② Securely install the recovery hook as illustrated. (The hook is stored in the trunk.)

Make sure that the recovery hook is properly secured in its storage area after use.

**Rear:**

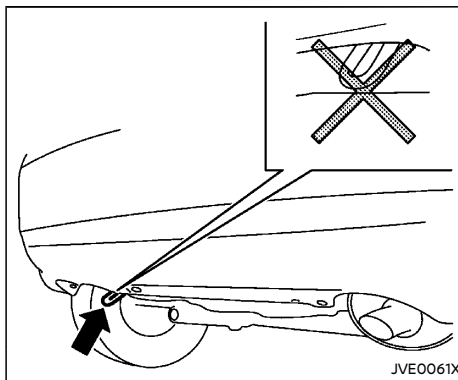

**Rear**

Do not use the hook to tow the vehicle.

**MEMO**

# 7 Appearance and care

Cleaning exterior .....	7-2	Cleaning interior .....	7-3
Washing .....	7-2	Air fresheners .....	7-4
Removing spots .....	7-2	Floor mats .....	7-4
Waxing .....	7-2	Glass .....	7-4
Glass .....	7-3	Seat belts .....	7-4
Underbody .....	7-3	Corrosion protection .....	7-5
Wheels .....	7-3	Most common factors contributing to vehicle corrosion .....	7-5
Aluminum alloy wheel (if equipped) .....	7-3	Environmental factors influence rate of corrosion .....	7-5
Chrome parts .....	7-3	To protect your vehicle from corrosion .....	7-5



## CLEANING EXTERIOR

In order to maintain the appearance of your vehicle, it is important to take proper care of it.

Whenever possible, park your vehicle inside a garage or in a covered area to minimize the chances of damaging the paint surface of your vehicle.

When it is necessary to park outside, park in a shady area or protect the vehicle with a body cover. **Be careful not to scratch the paint surface when putting on or removing the body cover.**

### WASHING

In the following instances, wash your vehicle as soon as possible to protect the paint surface:

- After a rainfall, which may cause the paint surface damage from acid rain.
  - After driving on coastal roads, which may cause rusting from the sea breeze.
  - When contaminants such as soot, bird droppings, tree sap, metal particles or bugs get on the paint surface.
  - When dust or mud builds up on the paint surface.
1. Wash the vehicle surface with a wet sponge and plenty of water.
  2. Clean the vehicle surface gently and thoroughly using a mild soap, a special vehicle soap or a general purpose dishwashing liquid mixed with clean, lukewarm (never hot) water.



#### CAUTION:

- **Do not wash the vehicle with strong household soap, strong chemical detergents, gasoline or solvents.**

- **Do not wash the vehicle in direct sunlight or while the vehicle body is hot, as the paint surface may become water-spotted.**
  - **Avoid using tight-napped or rough cloths, such as washing mitts. Care must be taken when removing caked-on dirt or other foreign substances so the paint surface is not scratched or damaged.**
  - **Do not use a commercial or high-pressure sprayer on the surface or edge of the sashes. This could damage them and cause the tapes (if equipped) to peel away from the sashes.**
3. Rinse the vehicle thoroughly with plenty of clean water.
  4. Use a dampened chamois to dry the paint surface and avoid leaving water spots.

When washing the vehicle, take care of the following:

- Inside flanges, joints and folds on the doors, hatches and hood are particularly vulnerable to the effects of road salt. Therefore, these areas must be cleaned regularly.
- Be sure that the drain holes in the lower edge of the doors are not clogged.
- Spray water to the underbody and in the wheel wells to loosen the dirt and/or wash away road salt.

## REMOVING SPOTS

Remove tar and oil spots, industrial dust, insects, and tree sap as quickly as possible from the paint surface to avoid lasting damage or staining. Special cleaning products are available at a NISSAN dealer or any automotive accessory store.

## WAXING

Regular waxing protects the paint surface and helps maintain a new vehicle appearance.

After waxing, polishing is recommended to remove built-up residue and to avoid a weathered appearance.

A NISSAN dealer can assist you in choosing the appropriate waxing products.



#### CAUTION:

- **Wash your vehicle thoroughly and completely before applying wax to the paint surface.**
- **Always follow the manufacturer's instructions supplied with the wax.**
- **Do not use a wax containing any abrasives, cutting compounds or cleaners that may damage the vehicle finish.**

Machine compounding or aggressive polishing on a base coat/clear coat paint finish may dull the finish or leave swirl marks.

## GLASS

Use glass cleaner to remove smoke and dust film from the glass surfaces. It is normal for glass to become coated with a film after the vehicle is parked in the hot sun. Glass cleaner and a soft cloth will easily remove this film.

## UNDERBODY

In areas where road salt is used in the winter, it is necessary to clean the vehicle's underbody regularly in order to prevent dirt and salt from building up and causing the acceleration of corrosion on the underbody and suspension.

Before the winter and again in the spring, the underseal must be checked and, if necessary, re-treated.

## WHEELS

- Wash the wheels when washing the vehicle to maintain their appearance.
- Clean the inner side of the wheels when the wheel is changed or the underside of the vehicle is washed.
- Do not use abrasive cleaners when washing the wheels.
- Inspect wheel rims regularly for dents or corrosion. This may cause loss of pressure or damage the tire bead.
- NISSAN recommends that the road wheels be waxed to protect against road salt in areas where it is used during winter.

## ALUMINUM ALLOY WHEEL (if equipped)

Wash the wheels regularly with a sponge dampened in a mild solution, especially during winter in areas where road salt is used.

The salt residue from road salt could discolor the wheels if it is not washed off regularly.



### CAUTION:

**Follow the directions below to avoid staining or discoloring the wheels:**

- **Do not use a cleaner that uses strong acid or alkali contents to clean the wheels.**
- **Do not apply wheel cleaners to the wheels when they are hot. The wheel temperature should be the same as ambient temperature.**
- **Rinse the wheel to completely remove the cleaner within 15 minutes after the cleaner is applied.**

## CHROME PARTS

Clean all chrome parts regularly with a non-abrasive chrome polish to maintain the finish.

## CLEANING INTERIOR

Occasionally remove loose dust from the interior trim, plastic parts and seats using a vacuum cleaner or soft bristled brush. Wipe the vinyl and leather surfaces with a clean, soft cloth dampened in mild soap solution, then wipe clean with a dry, soft cloth.

Regular care and cleaning is required in order to maintain the appearance of the leather.

Before using any fabric protector, read the manufacturer's recommendations. Some fabric protectors contain chemicals that may stain or bleach the seat material.

Use a soft cloth dampened only with water to clean the meter and gauge lens covers.



### CAUTION:

- **Never use benzine, thinner or any similar material.**
- **Small dirt particles can be abrasive and damaging to leather surfaces and should be removed promptly. Do not use saddle soap, car waxes, polishes, oils, cleaning fluids, solvents, detergents or ammonia-based cleaners as they may damage the leather natural finish.**
- **Never use fabric protectors unless recommended by the manufacturer.**
- **Do not use glass or plastic cleaner on meter or gauge lens covers. It may damage the lens covers.**
- **Do not use the chlorine-based cleaning liquid such as chlorine dioxide and hypochlorous acid, which may cause the paint peeling, corrosion, etc. If it is unavoidable to clean or sterilize interior surfaces, use less than 75% ethanol. Wipe the interior parts with a dry cloth dampened with ethanol. Wipe off ethanol completely. If**

**you leave it uncleaned, it may cause paint peeling, discoloration, etc. Since ethanol is flammable, be careful of fire.**

## AIR FRESHENERS

Most air fresheners use a solvent that could affect the vehicle interior. If you use an air freshener, take the following precautions:

- Hanging-type air fresheners can cause permanent discoloration when they contact vehicle interior surfaces. Place the air freshener in a location that allows it to hang free and not contact an interior surface.
- Liquid-type air fresheners typically clip on the vents. These products can cause immediate damage and discoloration when spilled on interior surfaces.

Carefully read and follow the manufacturer's instructions before using air fresheners.

## FLOOR MATS

The use of genuine NISSAN floor mats (if equipped) can extend the life of your vehicle carpet and make it easier to clean the interior. Regardless of what mats are used, be sure they are fitted for your vehicle and are properly positioned in the foot well to prevent interference with pedal operation. Mats should be maintained with regular cleaning and replaced if they become excessively worn.

## Floor mat positioning aid

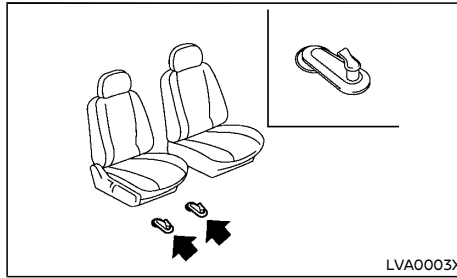

This vehicle includes a front floor mat bracket to act as a floor mat positioning aid. NISSAN floor mats have been specially designed for your vehicle model. The driver's floor mat has a grommet hole incorporated in it.

Position the mat by placing the floor mat bracket hook through the floor mat grommet hole while centering the mat in the foot area.

Periodically check that the mats are properly positioned.

## GLASS

Use glass cleaner to remove smoke and dust film from the glass surfaces. It is normal for glass to become coated with a film after the vehicle is parked in the hot sun. Glass cleaner and a soft cloth will easily remove this film.



### CAUTION:

**When cleaning the inside of the windows, do not use sharp-edged tools, abrasive cleaners or chlorine-based disinfectant cleaners. They could damage the electrical conductors, such as rear window defogger elements.**

## SEAT BELTS



### WARNING:

- **Do not allow wet seat belts to roll up in the retractor.**
- **Never use bleach, dye or chemical solvents to clean the seat belts, since these materials may severely weaken the seat belt webbing.**

The seat belts can be cleaned by wiping them with a sponge dampened in a mild soap solution.

Allow the belts to dry completely in the shade before using them. (See "Seat belts" (P.1-6).)



## CORROSION PROTECTION

### MOST COMMON FACTORS CONTRIBUTING TO VEHICLE CORROSION

- The accumulation of moisture-retaining dirt and debris in body panel sections, cavities, and other areas.
- Damage to the paint surface and other protective coatings caused by gravel and stone chips or minor traffic accidents.

### ENVIRONMENTAL FACTORS INFLUENCE RATE OF CORROSION

#### Moisture

The accumulation of sand, dirt and water on the inside floor of the vehicle can accelerate corrosion. Wet floor carpet/floor mats will not dry completely inside the vehicle. They should be removed and completely dried to avoid floor panel corrosion.

#### Relative humidity

Corrosion will be accelerated in areas of high relative humidity.

#### Temperature

High temperatures accelerate the rate of corrosion to those parts which are not well ventilated.

Corrosion will also be accelerated in areas where the temperatures stay above freezing.

#### Air pollution

Industrial pollution, the presence of salt in the air in coastal areas, or heavy road salt use accelerates the corrosion process. Road salt also accelerates the disintegration of paint surfaces.

### TO PROTECT YOUR VEHICLE FROM CORROSION

- Wash and wax your vehicle often to keep the vehicle clean.
- Always check for minor damage to the paint surface and if any exists, repair it as soon as possible.
- Keep the drain holes in the lower edge of the doors open to avoid water accumulation.
- Check the vehicle underbody for accumulation of sand, dirt or salt. If present, wash with water as soon as possible.



#### CAUTION:

- **Never remove dirt, sand or other debris from the passenger compartment by washing it out with a hose. Remove dirt with a vacuum cleaner or broom.**
- **Never allow water or other liquids to come in contact with electronic components inside the vehicle as this may damage them.**

Chemicals used for road surface deicing are extremely corrosive. They accelerate corrosion and deterioration of underbody components such as the exhaust system, fuel and brake lines, brake cables, floor pan and fenders.

**In the winter, the underbody must be cleaned periodically.**

For additional protection against rust and corrosion, which may be required in some areas, consult a NISSAN dealer.

**MEMO**

# 8 Maintenance and do-it-yourself

Maintenance requirements .....	8-2	Wiper blades .....	8-12
Scheduled maintenance .....	8-2	Windshield wiper blades .....	8-12
General maintenance .....	8-2	Window washer fluid .....	8-13
Where to go for service .....	8-2	Battery .....	8-14
General maintenance .....	8-2	Vehicle battery .....	8-14
Explanation of general maintenance items .....	8-2	Remote controller battery .....	8-15
Maintenance precautions .....	8-4	Intelligent Key battery .....	8-16
Engine compartment check locations .....	8-5	Fuses .....	8-17
HRAODET engine model .....	8-5	Engine compartment .....	8-17
Engine cooling system .....	8-6	Passenger compartment .....	8-18
Checking engine coolant level .....	8-6	Lights .....	8-19
Changing engine coolant .....	8-6	Headlights .....	8-19
Engine oil .....	8-7	Exterior lights .....	8-19
Checking engine oil level .....	8-7	Interior lights .....	8-20
Changing engine oil and oil filter .....	8-7	Light locations .....	8-21
Protect environment .....	8-8	Tires and wheels .....	8-23
Drive belts .....	8-9	Tire inflation pressure .....	8-23
Spark plugs .....	8-9	Types of tires .....	8-23
Iridium platinum-tipped spark plugs .....	8-9	Tire chains .....	8-24
Brakes .....	8-9	Tire rotation .....	8-24
Checking parking brake .....	8-9	Tire wear and damage .....	8-24
Checking foot brake pedal .....	8-9	Tire age .....	8-25
Brake booster .....	8-10	Changing tires and wheels .....	8-25
Brake fluid .....	8-10	Wheel balance .....	8-25
Clutch fluid (if equipped) .....	8-11	Spare tire (if equipped) .....	8-25
Continuously Variable Transmission (CVT) fluid (if equipped) .....	8-11	Emergency tire puncture repair kit (if equipped) .....	8-26
Air cleaner filter .....	8-12		

## MAINTENANCE REQUIREMENTS

Some day-to-day and regular maintenance is essential to maintain your vehicle's good mechanical condition, as well as its emission and engine performance.

It is the owner's responsibility to make sure that the specified maintenance, as well as general maintenance, is performed.

As the vehicle owner, you are the only one who can ensure that your vehicle receives the proper maintenance care.

### SCHEDULED MAINTENANCE

For your convenience, the required scheduled maintenance items are described and listed in a separate Warranty Information and Maintenance booklet. You must refer to that booklet to ensure that necessary maintenance is performed on your vehicle at regular intervals.

### GENERAL MAINTENANCE

General maintenance includes those items which should be checked during normal day-to-day operation of the vehicle. They are essential if your vehicle is to continue to operate properly. It is your responsibility to perform these procedures regularly as prescribed.

Performing general maintenance checks requires minimal mechanical skill and only a few general automotive tools.

These checks or inspections can be done by yourself, a qualified technician, or if you prefer, your NISSAN dealer.

### WHERE TO GO FOR SERVICE

If maintenance service is required or your vehicle appears to malfunction, have the systems checked and tuned by an authorized NISSAN dealer.

## GENERAL MAINTENANCE

During normal day-to-day operation of the vehicle, general maintenance should be performed regularly as prescribed in this section. If you detect any unusual sounds, vibrations or smells, be sure to check for the cause or have a NISSAN dealer do it promptly. In addition, you should notify a NISSAN dealer if you think that repairs are required.

When performing any checks or maintenance work, closely observe "Maintenance precautions" (P.8-4).

### EXPLANATION OF GENERAL MAINTENANCE ITEMS

**Additional information on the following items with "" is found later in this section.**

#### Outside vehicle

The maintenance items listed here should be performed from time to time, unless otherwise specified.

#### **Doors and hood:**

Check that all doors and the hood operate smoothly as well as the back door, trunk lid and hatch. Also make sure that all latches lock securely. Lubricate if necessary. Make sure that the secondary latch keeps the hood from opening when the primary latch is released. When driving in areas using road salt or other corrosive materials, check lubrication frequently.

#### **Lights\*:**

Clean the headlights on a regular basis. Make sure that the headlights, stop lights, tail lights, turn signal lights, and other lights are all operating properly and installed securely. Also check the aim of the headlights.

**Tires\*:**

Check the pressure with a gauge often and always prior to long distance trips. Adjust the pressure in all tires, including the spare, to the pressure specified. Check carefully for damage, cuts or excessive wear.

**Tire rotation\*:**

In the case that Two-Wheel Drive (2WD) and front and rear tires are same size; tires should be rotated every 10,000 km (6,000 miles). Tires marked with directional indicators can only be rotated between front and rear. Make sure that the directional indicators point in the direction of wheel rotation after the tire rotation is completed.

In the case that Four-Wheel Drive and All-Wheel Drive (4WD/AWD) and front and rear tires are same size; tires should be rotated every 5,000 km (3,000 miles). Tires marked with directional indicators can only be rotated between front and rear. Make sure that the directional indicators point in the direction of wheel rotation after the tire rotation is completed.

In the case that front tires are different size from rear tires; tires cannot be rotated.

However, the timing for tire rotation may vary according to your driving habits and the road surface conditions.

**Tire Pressure Monitoring System (TPMS) transmitter components (if so equipped):**

Replace the TPMS transmitter grommet seal, valve core and cap when the tires are replaced due to wear or age.

**Wheel alignment and balance:**

If the vehicle should pull to either side while driving on a straight and level road, or if you detect uneven or abnormal tire wear, there may be a need for wheel alignment. If the steering wheel or seat vibrates at normal highway speeds, wheel balancing may be needed.

**Windshield:**

Clean the windshield on a regular basis. Check the windshield at least every six months for cracks or other damage. Repair as necessary.

**Wiper blades\*:**

Check for cracks or wear if not functioning correctly. Replace as necessary.

**Inside vehicle**

The maintenance items listed here should be checked on a regular basis, such as when performing periodic maintenance, cleaning the vehicle, etc.

**Accelerator pedal:**

Check the pedal for smooth operation and make sure that the pedal does not catch or require uneven effort. Keep the floor mats away from the pedal.

**Brake pedal\*:**

Check the pedal for smooth operation and make sure that it is the proper distance from the floor mat when depressed fully. Check the brake booster function. Be sure to keep the floor mats away from the pedal.

**Parking brake\*:**

Check the parking brake operation regularly. Check that the lever (if so equipped) or the pedal (if so equipped) has the proper travel. Also make sure that the vehicle is held securely on a fairly steep hill when only the parking brake is applied.

**Seat belts:**

Check that all parts of the seat belt system (for example, buckles, anchors, adjusters and retractors) operate properly and smoothly, and are installed securely. Check the belt webbing for cuts, fraying, wear or damage.

**Steering wheel:**

Check for changes in the steering condition, such as excessive play, hard steering or strange noises.

**Warning lights and chimes:**

Make sure that all warning lights and chimes are operating properly.

**Windshield defogger:**

Check that the air comes out of the defogger outlets properly and in good quantity when operating the heater or air conditioner.

**Windshield wiper and washer\*:**

Check that the wipers and washer operate properly and that the wipers do not streak.

**Under hood and vehicle**

The maintenance items listed here should be checked periodically (for example, each time you check the engine oil or refuel).

### **Battery\* (except for maintenance free batteries) :**

Check the fluid level in each cell. It should be between the UPPER and LOWER lines. Vehicles operated in high temperatures or under severe conditions require frequent checks of the battery fluid level.

### **Brake (and clutch) fluid level(s)\*:**

For Manual Transmission (MT) model; make sure that the brake and clutch fluid levels are between the MAX and MIN lines on the reservoirs.

Except for Manual Transmission (MT) model; make sure that the brake fluid level is between the MAX and MIN lines on the reservoir.

### **Engine coolant level\* :**

Check the coolant level when the engine is cold. Make sure that the coolant level is between the MAX and MIN lines on the reservoir.

### **Engine drive belt(s)\*:**

Make sure that drive belt(s) is not frayed, worn, cracked or oily.

### **Engine oil level\*:**

Check the level after parking the vehicle (on a level ground) and turning off the engine.

### **Fluid leaks:**

Check under the vehicle for fuel, oil, water or other fluid leaks after the vehicle has been parked for a while. Water dripping from the air conditioner after use is normal. If you should notice any leaks or if fuel fumes are evident, check for cause and have it corrected immediately.

### **Window washer fluid\*:**

Check that there is adequate fluid in the reservoir.

## **MAINTENANCE PRECAUTIONS**

When performing any inspection or maintenance work on your vehicle, always take care to prevent serious accidental injury to yourself or damage to the vehicle. The following are general precautions which should be closely observed.



### **WARNING:**

- **Park the vehicle on a level surface, apply the parking brake securely and block the wheels to prevent the vehicle from moving. Move the shift lever to the "P" (Park) position (Continuously Variable Transmission model) or the "N" (Neutral) position (Manual Transmission model).**
- **Be sure the ignition switch is in the "OFF" or "LOCK" position when performing any parts replacement or repairs.**
- **Do not work under the hood while the engine is hot. Always turn off the engine and wait until it cools down.**
- **If you must work with the engine running, keep your hands, clothing, hair and tools away from moving fans, belts and any other moving parts.**
- **It is advisable to secure or remove any loose clothing and any jewelry, such as rings, watches, etc. before working on your vehicle.**
- **If you must run the engine in an enclosed space such as a garage, be sure there is proper ventilation for exhaust gases to escape.**

- **Never get under the vehicle while it is supported by a jack.**
- **Keep smoking materials, flame and sparks away from fuel and the battery.**
- **Never connect or disconnect either the battery or any transistorized component connector while the ignition switch is in the "ON" position.**
- **On gasoline engine models with the Multiport Fuel Injection (MFI) system, the fuel filter and fuel lines should be serviced by a NISSAN dealer because the fuel lines are under high pressure even when the engine is turned off.**
- **Your vehicle is equipped with an automatic engine cooling fan. It may come on at any time without warning, even if the ignition switch is in the "OFF" position and the engine is not running. To avoid injury, always disconnect the negative battery cable before working near the fan.**
- **Always wear eye protection whenever you work on your vehicle.**
- **Never leave the engine or the transmission related component harness connector disconnected while the ignition switch is in the "ON" position.**
- **Avoid direct contact with used engine oil and coolant. Improperly disposed engine oil, engine coolant, and/or other vehicle fluids can hurt the environment. Always conform to local regulations for disposal of vehicle fluids.**

This "8. Maintenance and do-it-yourself" section provides instructions regarding only those items which are relatively easy for an owner to perform.

## ENGINE COMPARTMENT CHECK LOCATIONS

You should be aware that incomplete or improper servicing may result in operating difficulties or excessive emissions, and could affect your warranty coverage. **If in doubt about any servicing, have it done by a NISSAN dealer.**

### HRAOJET ENGINE MODEL

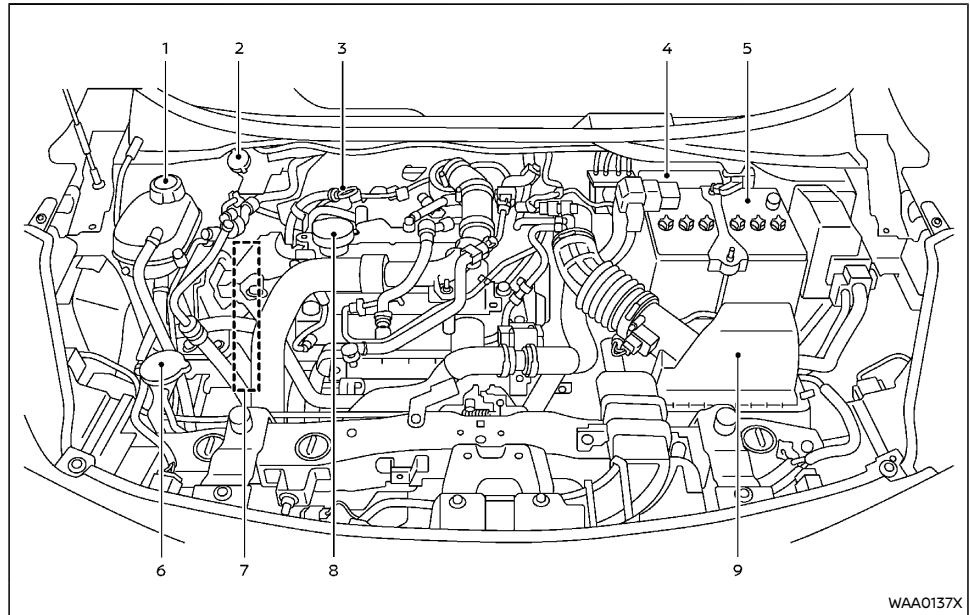

WAA0137X

- |   |   |
|---|---|
| 1. Engine coolant reservoir             | 9. Air cleaner  |
| 2. Brake and clutch*1 fluid reservoir*2 | *1: For Manual Transmission (MT) model  |
| 3. Engine oil dipstick                  | *2: The layout illustrated is for the Right-Hand Drive (RHD) model. On the Left-Hand Drive (LHD) model, brake (and clutch) fluid reservoir is located on the opposite side. |
| 4. Fuse/fusible link box                |   |
| 5. Battery                              |   |
| 6. Window washer fluid reservoir        |   |
| 7. Engine drive belt location           |   |
| 8. Engine oil filler cap                |   |

## ENGINE COOLING SYSTEM

### WARNING:

- Never remove the radiator or coolant reservoir cap when the engine is hot. Serious burns could be caused by high-pressure fluid escaping from the radiator. Wait until the engine and radiator cool down.
- Engine coolant is poisonous and should be stored carefully in marked containers out of the reach of children.

The engine cooling system is filled at the factory with a high-quality, year-round, anti-freeze coolant solution. The anti-freeze solution contains rust and corrosion inhibitors, therefore additional cooling system additives are not necessary.

### CAUTION:

- Never use any cooling system additives such as radiator sealer. Additives may clog the cooling system and cause damage to the engine, transmission and/or cooling system.
- When adding or replacing coolant, be sure to use only Genuine NISSAN Engine Coolant or equivalent in its quality with the proper mixture ratio. Examples of the mixture ratio of coolant and water are shown in the following table:

Outside temperature down to		Composition	
°C	°F	Engine coolant (concentrated)	Deminer-alized or distilled water
-15	5	30%	70%
-35	-30	50%	50%

The use of other types of coolant solutions may damage the engine cooling system.

The radiator is equipped with a pressure cap. To prevent engine damage, use only a Genuine NISSAN radiator cap or its equivalent when replacement is required.

### CHECKING ENGINE COOLANT LEVEL

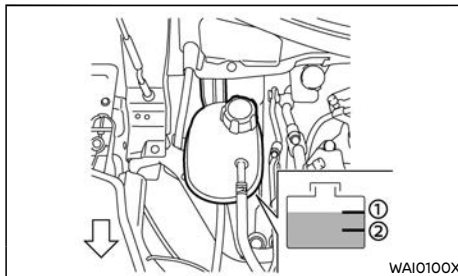

Check the coolant level in the reservoir when the engine is cold. If the coolant level is below the MIN level ②, add coolant up to the MAX level ①. If the reservoir is empty, check the coolant level in the radiator **when the engine is cold**. If there is insufficient coolant in the radiator, fill the radiator with coolant up to the filler opening and also add it to the reservoir up to the MAX level ①.

**If the cooling system frequently requires coolant, have it checked by a NISSAN dealer.**

### CHANGING ENGINE COOLANT

Contact a NISSAN dealer if replacement is required.

Major engine cooling system repair should be performed by a NISSAN dealer. The service procedures can be found in the appropriate NISSAN Service Manual.

Improper servicing can result in reduced heater performance and engine overheating.

### WARNING:

- To avoid being scalded, never change the coolant when the engine is hot.
- Never remove the radiator cap when the engine is hot. Serious burns could be caused by high pressure fluid escaping from the radiator.
- Avoid direct skin contact with used coolant. If skin contact is made, wash thoroughly with soap or hand cleaner as soon as possible.
- Keep coolant out of reach of children and pets.

Engine coolant must be disposed of properly. Check your local regulations.



## ENGINE OIL

### CHECKING ENGINE OIL LEVEL

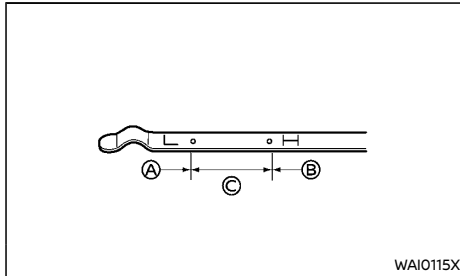

1. Park the vehicle on a level surface and apply the parking brake.
2. Start the engine and warm it up until the engine temperature reaches the normal operating temperature (approximately 5 minutes).
3. Stop the engine.
4. Wait at least 15 minutes for the engine oil to drain back to the oil pan.
5. Remove the dipstick and wipe it clean.
6. Reinsert the dipstick all the way.
7. Remove the dipstick and check the oil level. It should be within the range C.
8. If the oil level is below A, remove the oil filler cap and pour the recommended oil into the opening. Do not overfill B.
9. Recheck the oil level with the dipstick.

**It is normal to add some oil between oil maintenance intervals or during the break-in period, depending on the severity of operating conditions.**

### CAUTION:

The oil level should be checked regularly. Operating your vehicle with an insufficient amount of oil can damage the engine, and such damage is not covered by warranty.

### CHANGING ENGINE OIL AND OIL FILTER

#### WARNING:

- Used oil must be disposed of properly. Never pour or dump oil into the ground, canals, rivers, etc. It should be disposed of at proper waste facilities. NISSAN recommends having your oil changed by a NISSAN dealer.
- Be careful not to burn yourself, as the engine oil may be hot.
- Prolonged and repeated contact with used engine oil may cause skin cancer.
- Avoid direct skin contact with used oil. If contacted, wash thoroughly with soap or hand cleaner and plenty of water as soon as possible.
- Store used engine oil in marked containers out of the reach of children.

#### CAUTION:

**Waste oil must be disposed of properly. Check your local regulations.**

### Engine oil replacement

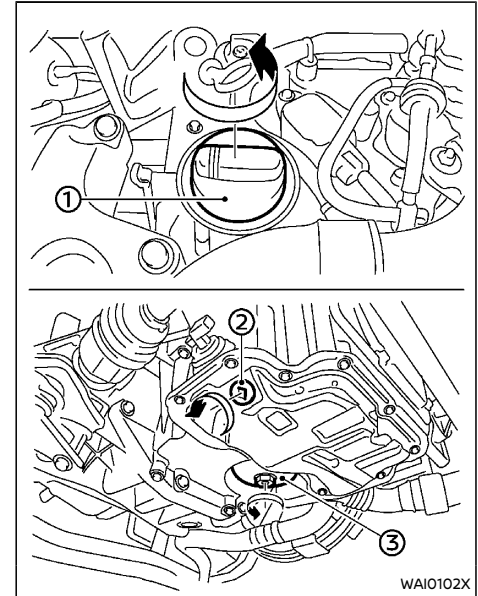

- ① Oil filler cap
- ② Oil drain plug
- ③ Oil filter

1. Park the vehicle on a level surface and apply the parking brake.
2. Start the engine and warm it up until the engine temperature reaches the normal operating temperature (approximately 5 minutes).

3. Stop the engine.
4. Wait at least 15 minutes for the engine oil to drain back to the oil pan.
5. Place a large drain pan under the drain plug.
6. Remove the drain plug with a wrench.
7. Remove the oil filler cap and completely drain the oil.  
If the oil filter is to be changed, remove and replace it at this time. (See "Engine oil filter replacement" (P.8-8).)
8. Clean and reinstall the drain plug and new washer. Securely tighten the drain plug with a wrench. Do not use excessive force.

**Drain plug tightening torque:**

**29.4 to 39.2 N·m**

**(3.0 to 4.0 kg·m, 22 to 29 ft·lb)**

9. Refill the recommended engine oil and quantity. (See "Recommended fluids/lubricants and capacities" (P.9-2).)  
**When filling the engine oil, do not remove the dipstick.**
10. Securely install the oil filler cap.
11. Start the engine.
12. Check the drain plug for any sign of leakage.
13. Check the engine oil level according to the proper procedure. (See "Checking engine oil level" (P.8-7).)

### Engine oil filter replacement

1. Park the vehicle on a level surface and apply the parking brake.
2. Turn the engine off.
3. Drain the engine oil according to the proper procedure. (See "Engine oil replacement" (P.8-7).)
4. Loosen the oil filter with an oil filter wrench.
5. Remove the oil filter by turning it by hand.
6. Wipe the engine oil filter mounting surface with a clean cloth.  
Be sure to remove any old gasket remaining on the mounting surface.
7. Apply the new engine oil to the gasket of the new oil filter.
8. Screw in the oil filter until a slight resistance is felt, and then tighten an additional 2/3 of turn to secure the oil filter.

**Oil filter tightening torque:**

**21.25 to 28.75 N·m (2.2 to 2.9 kg·m, 16 to 21 ft·lb)**

9. Refill the engine oil. (See "Engine oil replacement" (P.8-7).)
10. Start the engine and check for leakage around the oil filter. Correct as required.
11. Turn the engine off and wait several minutes.
12. Check the engine oil level according to the proper procedure. (See "Checking engine oil level" (P.8-7).)

### PROTECT ENVIRONMENT

It is illegal to pollute drains, watercourses and soil. Use authorized waste collection facilities, including civil amenity sites and garages providing facilities for disposal of used oil and used oil filters. If in doubt, contact your local authority for advice on disposal.

**The regulations concerning the pollution of the environment will vary from country to country.**

## DRIVE BELTS

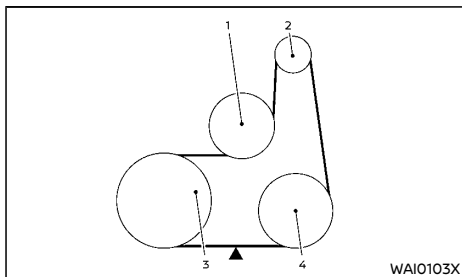

1. Water pump
2. Alternator
3. Crankshaft pulley
4. Air conditioner compressor

▲: Tension checking point

Be sure the ignition switch is in the "OFF" position.

Visually inspect each belt for signs of unusual wear, cuts, fraying or looseness. Check regularly for condition and tension. If the belt is in poor condition or loose, have it replaced by a NISSAN dealer.

## SPARK PLUGS



### WARNING:

**Be sure the engine and ignition switch are off and that the parking brake is applied.**

Replace the spark plugs according to the maintenance log shown in a separate maintenance booklet.

If replacement is required, contact a NISSAN dealer.

### IRIDIUM PLATINUM-TIPPED SPARK PLUGS

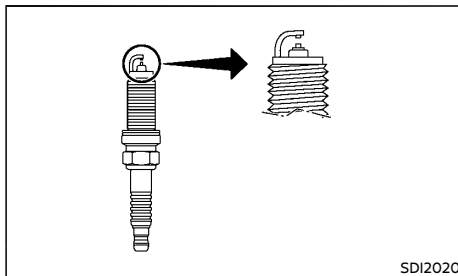

It is not necessary to replace the Iridium platinum-tipped spark plugs as frequently as the conventional type of spark plugs. These spark plugs are designed to last much longer than the conventional type of spark plug.



### CAUTION:

- Do not reuse the Iridium platinum-tipped spark plugs by cleaning or re-gapping.
- Always replace with the recommended Iridium platinum-tipped spark plugs.

## BRAKES

### CHECKING PARKING BRAKE

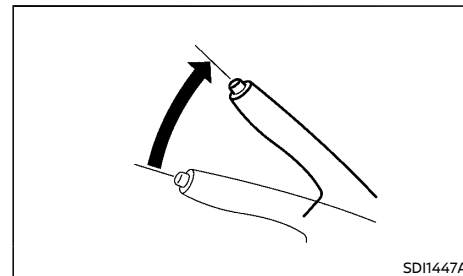

From the released position, pull the parking brake lever up slowly and firmly. If the number of clicks is out of the range listed, see a NISSAN dealer.

**9 to 10 clicks**

**Pulling force 196 N (20 kg, 44 lb)**

### CHECKING FOOT BRAKE PEDAL

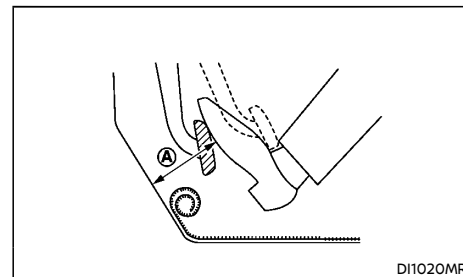



### WARNING:

See a NISSAN dealer for a brake system check if the foot brake pedal height does not return to normal.

With the engine running, check the distance (A) between the upper surface of the pedal and the metal floor. If it is out the range listed, see a NISSAN dealer.

(A) **Depressing force**  
**490 N (50 kg, 110 lb)**  
**80 mm (3.15 in) or more**

### Self-adjusting brakes

Your vehicle is equipped with self-adjusting brakes. The brakes are adjusted by the foot brake pedal operation.

### Brake pad wear indicator

The disc brake pads on your vehicle have audible wear indicators. When a brake pad requires replacement, it will make a high pitched scraping or screeching sound when the vehicle is in motion. The noise will be heard whether or not the foot brake pedal is depressed. Have the brakes checked as soon as possible if the wear indicator sound is heard.

Under some driving or climate conditions, occasional brake squeaks, squeals or other noises may be heard. Occasional brake noise during light to moderate stops is normal and does not affect the function or performance of the brake system.

Proper brake inspection intervals should be followed. For additional information, see a separate maintenance booklet.

### BRAKE BOOSTER

Check the brake booster function as follows:

1. With the engine off, depress and release the foot brake pedal several times. When the foot brake pedal movement (distance of travel) remains the same from one pedal application to the next, continue on to the next step.
2. While depressing the foot brake pedal, start the engine. The pedal height should drop a little.
3. With the foot brake pedal depressed, stop the engine. Keep the pedal depressed for about 30 seconds. The pedal height should not change.
4. Run the engine for 1 minute without depressing the foot brake pedal, then turn it off. Depress the foot brake pedal several times. The pedal travel distance will decrease gradually with each depression as the vacuum is released from the booster.

If the brakes do not operate properly, have the brakes checked by a NISSAN dealer.

### BRAKE FLUID



### WARNING:

- Use only new fluid from a sealed container. Old, inferior, or contaminated fluid may damage the brake system. The use of improper fluids can damage the brake system and affect the vehicle's stopping ability.
- Clean the filler cap before removing.
- Brake fluid is poisonous and should be stored carefully in marked containers out of the reach of children.



### CAUTION:

Do not spill the fluid on painted surfaces. This will damage the paint. If fluid is spilled, wash it off with plenty of water immediately.

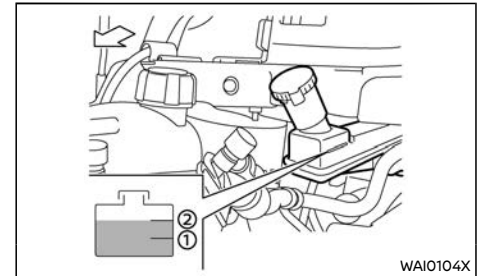

### Right-Hand Drive (RHD) model

Check the fluid level in the reservoir. If the brake fluid is below the MIN line (1), the brake warning light will illuminate. Add brake fluid up to the MAX line (2). (See "Recommended fluids/lubricants and capacities" (P.9-2) for recommended types of brake fluid.)

If the brake fluid must be added frequently, the brake system should be thoroughly checked by

a NISSAN dealer.

## CLUTCH FLUID (if equipped)



### WARNING:

- Use only new fluid from a sealed container. Old, inferior, or contaminated fluid may damage the clutch system.
- Clean the filler cap before removing.
- Clutch fluid is poisonous and should be stored carefully in marked containers out of the reach of children.



### CAUTION:

Do not spill the clutch fluid on painted surfaces. This will damage the paint. If clutch fluid is spilled, wash it off with plenty of water immediately.

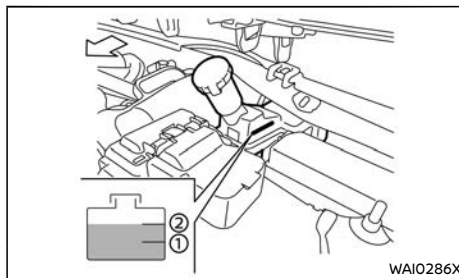

Check the fluid level in the reservoir. If the fluid is below the MIN line ①, add fluid up to the MAX line ②. (For recommended types of fluid, see "Recommended fluids/lubricants and capacities" (P.9-2).)

If the fluid must be added frequently, the clutch system should be thoroughly checked by a NISSAN dealer.

## CONTINUOUSLY VARIABLE TRANSMISSION (CVT) FLUID (if equipped)

Contact a NISSAN dealer if checking or replacement is required.



### CAUTION:

- Use only Genuine NISSAN CVT Fluid NS-3. Do not mix with other fluids.
- Using transmission fluid other than Genuine NISSAN CVT Fluid NS-3 will damage the CVT, which is not covered by the warranty.

## AIR CLEANER FILTER

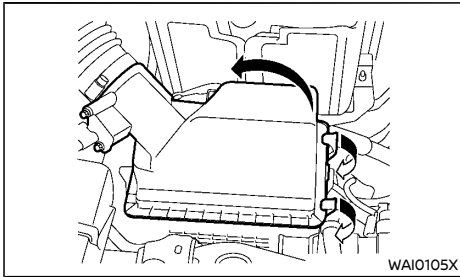

### WARNING:

Operating the engine with the air cleaner filter off can cause you or others to be burned. The air cleaner filter not only cleans the intake air, it also stops flame if the engine backfires. If the air cleaner filter is not installed and the engine backfires, you could be burned. Never drive with the air cleaner filter off. Be cautious working on the engine when the air cleaner filter is off.

To remove the filter, release the lock pins and pull the unit upward.

The viscous paper type filter element should not be cleaned and reused.

The dry paper type filter element may be cleaned and reused.

Replace the air cleaner filter according to the maintenance log shown in a separate maintenance booklet.

## WIPER BLADES

### WINDSHIELD WIPER BLADES

#### Cleaning

If the windshield does not become clear after using the windshield washer or if the wiper blades chatter when operating the windshield wipers, wax or other materials may be on the windshield and/or wiper blades.

Clean the outside of the windshield surface with a washer solution or mild detergent. Your windshield is clean if beads do not form when rinsing with water.

Clean the blade by wiping it with a cloth soaked in a washer solution or a mild detergent. Rinse the blade with water. If your windshield is still not clear after cleaning the blades and using the wipers, replace the blades.

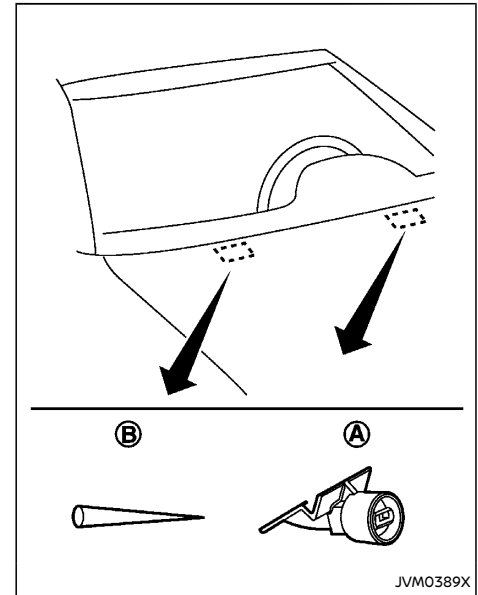

Be careful not to clog the washer nozzle (A). This may cause improper windshield washer operation. If the nozzle is clogged, remove any objects with a needle or small pin (B). Be careful not to damage the nozzle.

## Replacing

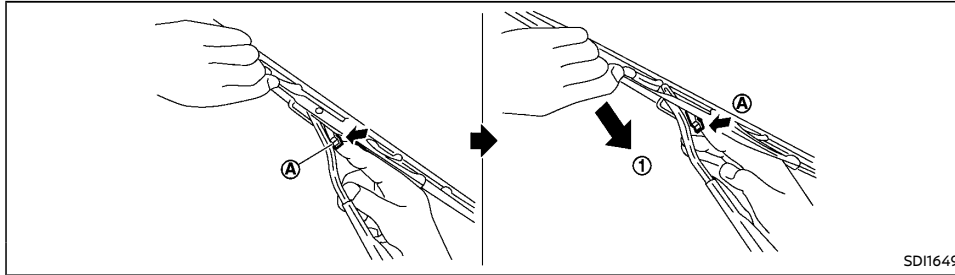

Example

1. Lift the wiper arm away from the windshield.  
**When lifting the wiper arm, lift the driver's side first, then the passenger's side. Otherwise, the wiper blades may be scratched and may cause damage.**
2. Push and hold the release tab (A), and then move the wiper blade down the wiper arm to remove (1).
3. Remove the wiper blade.
4. Insert the new wiper blade onto the wiper arm until it clicks into place.



### CAUTION:

- After wiper blade replacement, return the wiper arm to its original position. Otherwise the wiper arm or the engine hood may be scratched and may cause damage.
- Worn windshield wiper blades can damage the windshield and impair driver vision.

## WINDOW WASHER FLUID

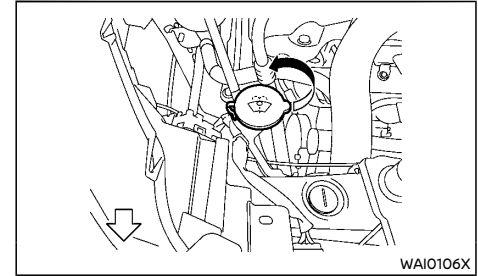

### WARNING:







**Anti-freeze is poisonous and should be stored carefully in marked containers out of the reach of children.**

Check the fluid level in the window washer reservoir. If the fluid level is low, add window washer fluid. Fill the window washer fluid reservoir periodically.

Add a washer solvent to the water for better cleaning. In the winter season, add a windshield washer anti-freeze. Follow the manufacturer's instructions for the mixture ratio.

## BATTERY

### VEHICLE BATTERY

Caution symbols for battery		⚠ WARNING	
①		No smoking, No exposed flames, No sparks	Never smoke around battery. Never expose battery to open flames or electrical sparks.
②		Shield eyes	Handle the battery cautiously. Always wear eye protection glasses to protect against explosion or battery acid.
③		Keep away from children	Never allow children to handle battery. Keep the battery out of the reach of children.
④		Battery acid	Do not allow battery fluid to contact your skin, eyes, fabrics, or painted surfaces. After handling the battery or battery cap, immediately wash your hands thoroughly. If the battery fluid gets into your eyes, or onto your skin or clothing, flush with water immediately for at least 15 minutes and seek medical attention. Battery fluid is acid. If the battery fluid gets into your eyes or onto your skin, it could cause loss of your eyesight or burns.
⑤		Note operating instructions	Before handling the battery, read this instruction carefully to ensure correct and safe handling.
⑥		Explosive gas	Hydrogen gas, generated by battery fluid, is explosive.

SD11573



#### WARNING:

**Do not operate the vehicle if the fluid in the battery is low. Low battery fluid can cause a higher load on the battery which can generate heat, reduce battery life, and in some cases lead to an explosion.**



## Checking battery fluid level

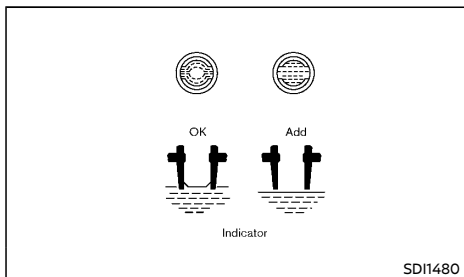
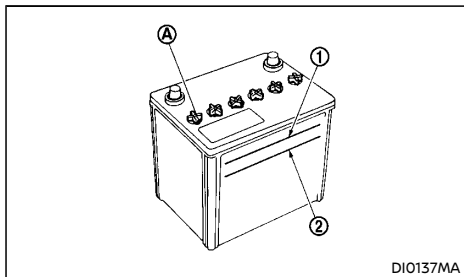

Check the fluid level in each cell. The battery fluid level should be between the UPPER LEVEL ① and LOWER LEVEL ② lines.

If it is necessary to add fluid, add only demineralized/distilled water to bring the level to the indicator in each filler opening. Do not overfill.

1. Remove the cell plugs ①, if equipped.
2. Add demineralized/distilled water up to the UPPER LEVEL ① line.
3. Replace and tighten the cell plugs.

- Vehicles operated in high temperatures or under severe conditions require frequent checks of the battery fluid level.
- Keep the battery surface clean and dry. Clean the battery with a solution of baking soda and water.
- Make certain the terminal connections are clean and securely tightened.
- If the vehicle is not to be used for more than 30 days, disconnect the negative (-) battery terminal cable to prevent battery discharge.

## Jump starting

If jump starting is necessary, see "Jump starting" (P.6-10). If the engine does not start by jump starting or the battery does not charge, the battery may have to be replaced. Contact a NISSAN dealer for replacing the battery.

## REMOTE CONTROLLER BATTERY

### Battery replacement



#### CAUTION:

- **Be careful not to allow children to swallow the battery and removed parts.**
- **An improperly disposed battery can harm the environment. Always confirm local regulations for battery disposal.**
- **When changing batteries, do not let dust or oil get on the components.**
- **There is danger of explosion if the lithium battery is incorrectly replaced. Replace only with the same or equivalent type.**
- **Do not expose the battery to excessive heat such as sunshine, fire, etc.**

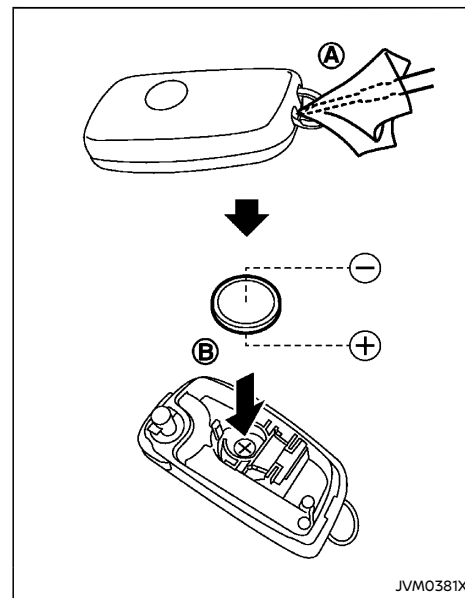

To replace the battery:

1. Insert a small screwdriver into the slit ① to open the lid. Use a cloth to protect the casing.
2. Replace the battery with a new one.

Recommended battery: CR2032 or equivalent

- Do not touch the internal circuit and electric terminals as doing so could cause a malfunction.

- Make sure that the ⊕ side faces the bottom of the case ⊗.
3. Close the lid securely.
  4. Operate the buttons to check its operation.
- See a NISSAN dealer if you need assistance for replacement.

## INTELLIGENT KEY BATTERY

### Battery replacement

#### CAUTION:

- **Be careful not to allow children to swallow the battery and removed parts.**
- **An improperly disposed battery can harm the environment. Always confirm local regulations for battery disposal.**
- **When changing batteries, do not let dust or oil get on the components.**
- **There is danger of explosion if lithium battery is incorrectly replaced. Replace only with the same or equivalent type.**

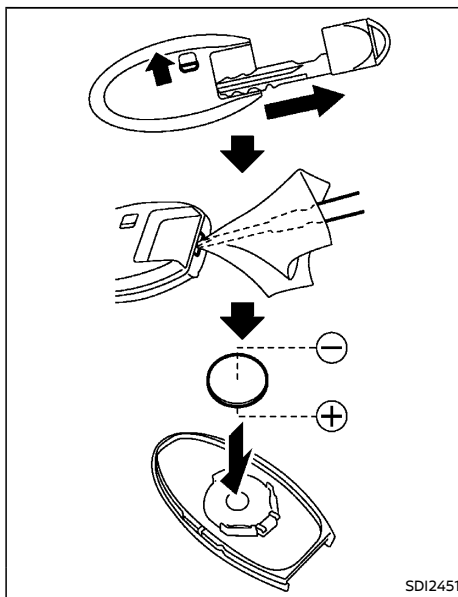

To replace the battery:

1. Release the lock knob at the back of the Intelligent Key and remove the mechanical key.
2. Insert a small screwdriver into the slit of the corner and twist it to separate the upper part from the lower part. Use a cloth to protect the casing.
3. Replace the battery with a new one.
  - Recommended battery: CR2032 or equivalent

- Do not touch the internal circuit and electric terminals as doing so could cause a malfunction.
- Make sure that the ⊕ side faces the bottom of the case.

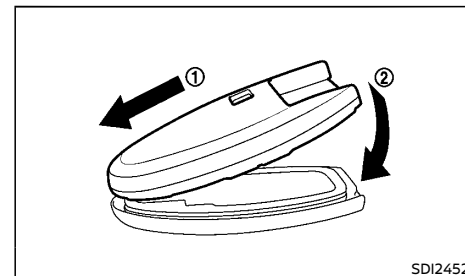

4. Align the tips of the upper and lower parts ①, and then push them together until it is securely closed ②.
  5. Operate the buttons to check its operation.
- See a NISSAN dealer if you need assistance for replacement.

## FUSES

### ENGINE COMPARTMENT

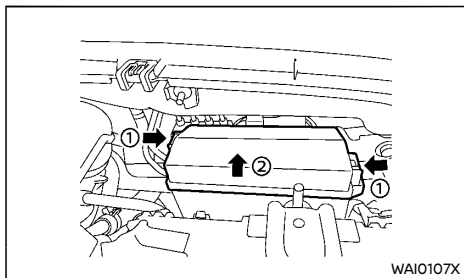

#### CAUTION:

Never use a fuse of a higher or lower amperage rating than that specified on the fuse box cover. This could damage the electrical system or cause a fire.

If any electrical equipment does not operate, check for an open fuse.

1. Be sure the ignition switch is in the "OFF" position.
2. Be sure the headlight switch is in the "OFF" position.
3. Open the engine hood.
4. Remove the fuse/fusible link holder cover by pushing the tabs ① and then lift the cover ②.
5. Locate the fuse that needs to be replaced.

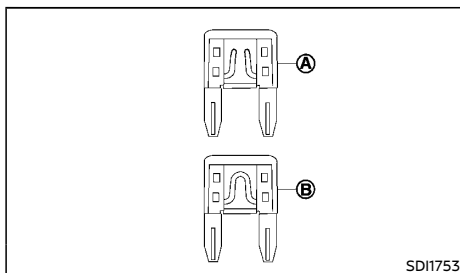

#### Example

6. Remove the fuse using the fuse puller located in the passenger compartment.
7. If the fuse is open ①, replace it with a new fuse ②.

If the new fuse also opens, after installing, have the electrical system checked, and if necessary repaired, by a NISSAN dealer.

#### Fusible links

If any electrical equipment does not operate and the fuses are in good condition, check the fusible links. If any of these fusible links are melted, replace only with genuine NISSAN parts.

## PASSENGER COMPARTMENT

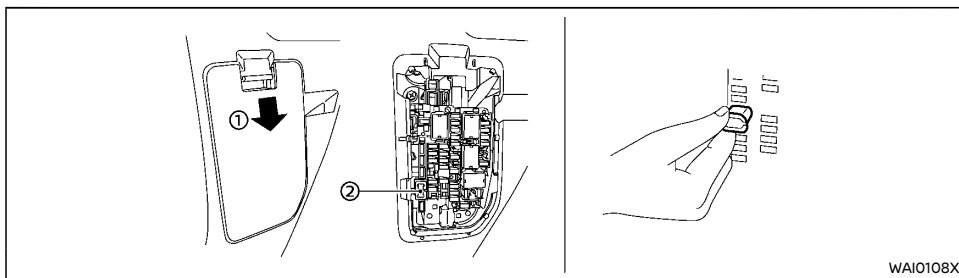

WAI0108X

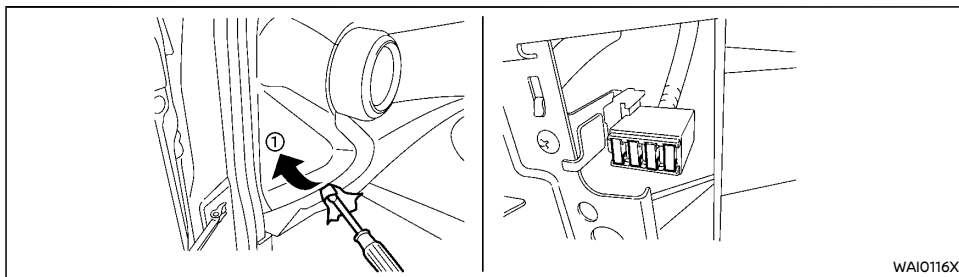

WAI0116X

### For Idling Stop System\* (if equipped)

check for an open fuse.

1. Be sure the ignition switch is in the "OFF" position.
2. Be sure the headlight switch is in the "OFF" position.
3. Remove the fuse box cover ①, if necessary, with a suitable tool.
4. Locate the fuse that needs to be replaced.
5. Remove the fuse using the fuse puller ②.

### CAUTION:

Never use a fuse of a higher or lower amperage rating than that specified on the fuse box cover. This could damage the electrical system or cause a fire.

\* The layout in the illustration shows that of the Right-Hand Drive (RHD) model. For the Left-Hand Drive (LHD) model, the layout will be the opposite.

If any electrical equipment does not operate,

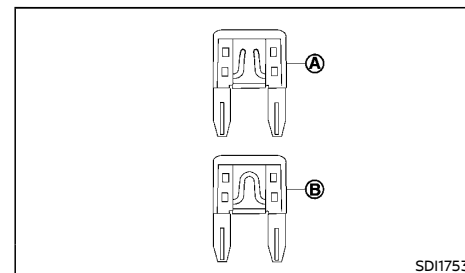

SDI1753

### Example

6. If the fuse is open ①, replace it with a new fuse ②.

If the new fuse also opens, after installing, have the electrical system checked, and if necessary repaired, by a NISSAN dealer.

### Extended storage fuse switch (if equipped)

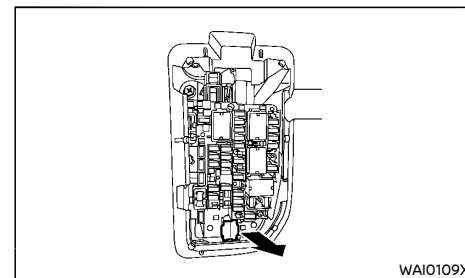

WAI0109X

To reduce battery drain, the extended storage fuse switch comes from the factory switched off. Prior to delivery of your vehicle, the switch is pushed in (switched on) and should always remain on.

If the extended storage fuse switch is not pushed in (switched on), a warning message

## LIGHTS

may appear in the vehicle information display. See "Vehicle information display (Type A)" (P.2-18) or "Vehicle information display (Type B)" (P.2-19).

If any electrical equipment does not operate, remove the extended storage fuse switch and push it in again.

### NOTE:

**If the extended storage fuse switch malfunctions, see a NISSAN dealer.**

### How to remove the extended storage fuse switch:

1. To remove the extended storage fuse switch, be sure the ignition switch is in the "OFF" or "LOCK" position.
2. Be sure the headlight switch is in the "OFF" position.
3. Remove the fuse box cover.
4. Pinch the storage fuse switch and pull it in the direction illustrated.

## HEADLIGHTS

Fog may temporarily form inside the lens of the exterior lights in the rain or in a car wash. A temperature difference between the inside and the outside of the lens causes the fog. This is not a malfunction. If large drops of water collect inside the lens, contact a NISSAN dealer.

### LED headlight bulb

If replacement is required, contact a NISSAN dealer.

### Halogen headlight bulb

If replacement is required, contact a NISSAN dealer.

The halogen headlight is a semi-sealed beam type which uses replaceable headlight (halogen) bulbs. They can be replaced from inside the engine compartment without removing the headlight assembly.



### CAUTION:

- **High-pressure halogen gas is sealed inside the bulb. The bulb may break if the glass envelope is scratched or the bulb is dropped.**
- **When handling the bulb, do not touch the glass envelope.**
- **Use the same number and wattage as originally installed:**

### Halogen headlight model

High beam bulb: 65W (H9)

Low beam bulb: 55W (H11)

- **Do not leave the bulb out of the headlight reflector for a long period of time as dust, moisture and smoke may enter the headlight body and affect the performance of**

### the headlight.

Aiming adjustment is not necessary if only the bulbs are replaced. When aiming adjustment is necessary, contact a NISSAN dealer.

## EXTERIOR LIGHTS

Item	Wattage (w)	
Front turn signal light	21	
Front clearance light	Halogen headlight model	5
	LED headlight model*	LED
Front fog light (if equipped)*	LED	
Daytime running light (if equipped)*	LED	
Side turn signal light		
Fender type	5	
Outside rearview mirror type*	LED	
Rear combination lights		
Turn signal light	21	
Stop light*	LED	
Tail light*	LED	
Reverse light	16	
High-mounted stop light*	LED	
License plate light*	5 (assembly)	

\*: See a NISSAN dealer for replacement.

## INTERIOR LIGHTS

Item	Wattage (W)
Map light	10
Room light	5
Trunk light	3.4

## LIGHT LOCATIONS

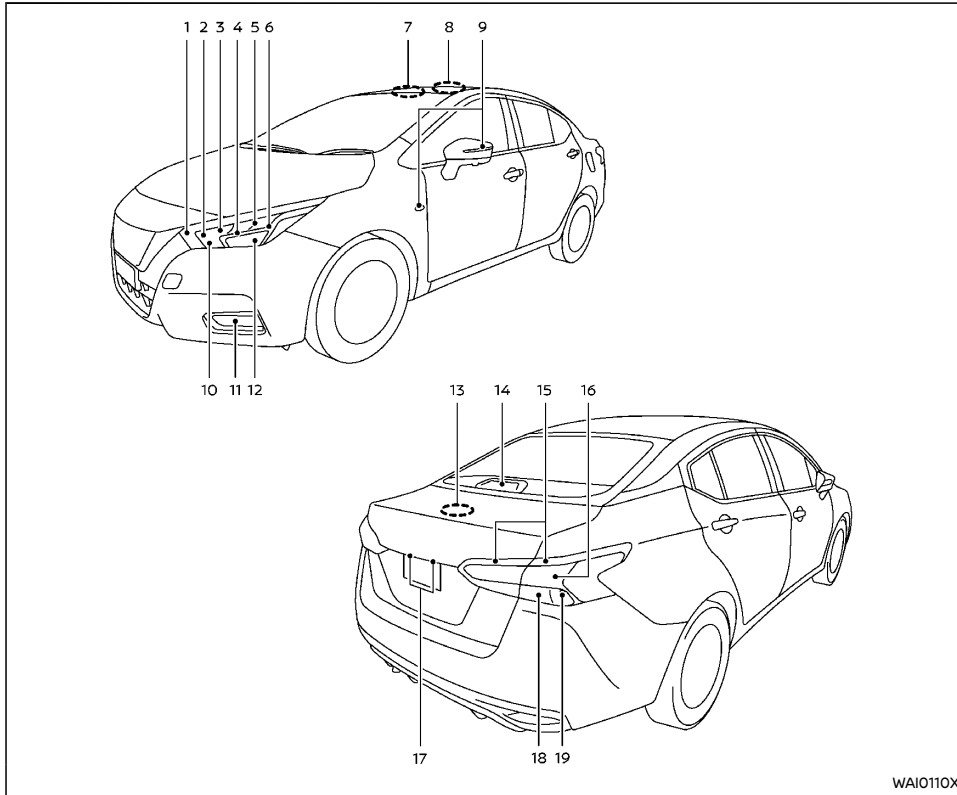

1. Clearance light/Daytime running light (LED headlight model) (if equipped)
2. Clearance light (Halogen headlight model)
3. Headlight (high-beam) (LED headlight model)
4. Headlight (high-beam) (Halogen headlight model)
5. Headlight (low-beam) (LED headlight model)
6. Headlight (low-beam) (Halogen headlight model)
7. Map light
8. Room light
9. Side turn signal light (on the front fender or the outside rearview mirror)
10. Front turn signal light (Halogen headlight model)
11. Front fog light (if equipped)
12. Front turn signal light (LED headlight model)
13. Trunk light
14. High-mounted stop light
15. Tail light
16. Stop light
17. License plate light
18. Reverse light
19. Rear turn signal light

## Replacement procedures

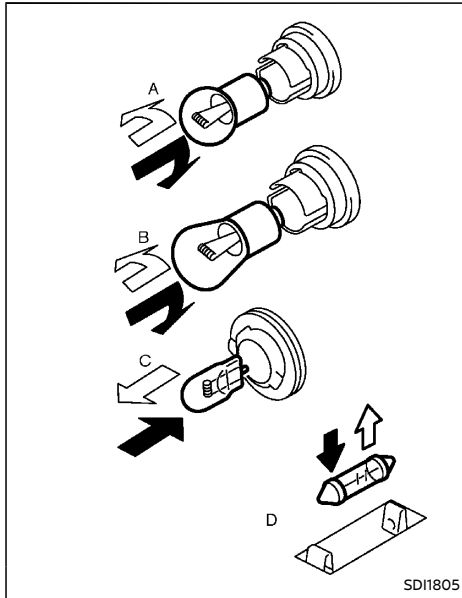

⇐: REMOVE  
⇒: INSTALL

All other lights are either type A, B, C or D. When replacing a bulb, first remove the lens and/or cover.



① Clearance light (Halogen headlight model)/  
② Front turn signal light

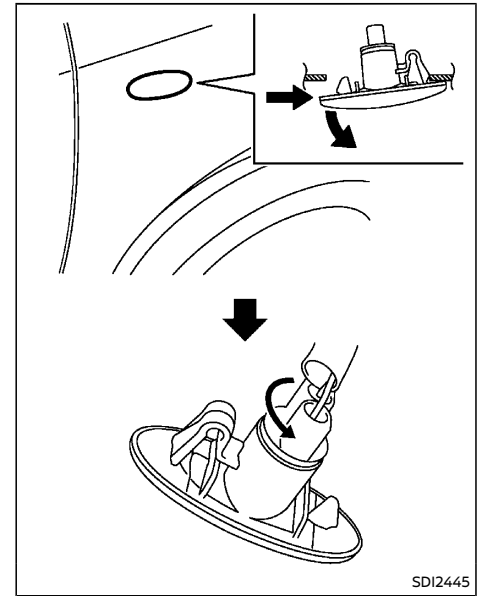

Side turn signal light (fender type)



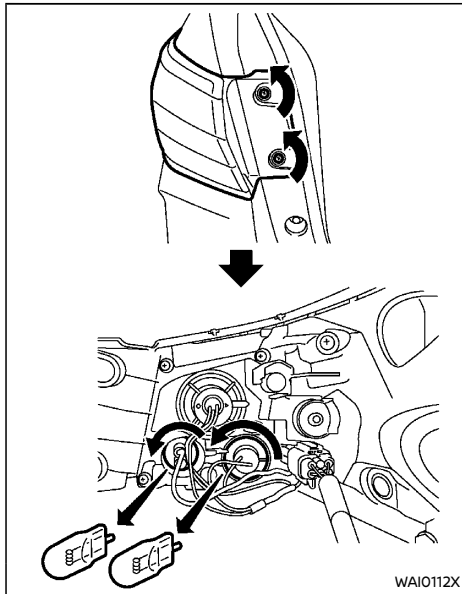

Rear combination light (Reverse light/Turn signal light)

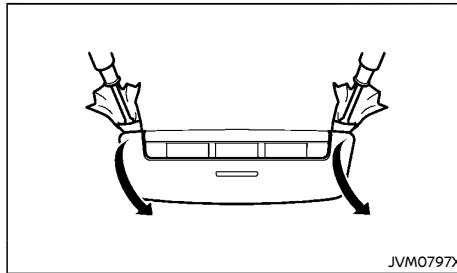

Map light

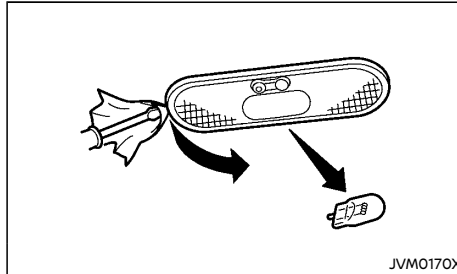

Room light

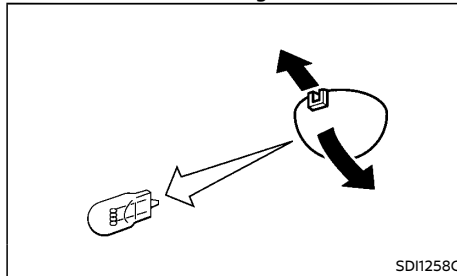

Trunk light

## TIRES AND WHEELS

If you have a flat tire, see "Flat tire" (P.6-2).

### TIRE INFLATION PRESSURE

Periodically check the pressure of the tires. An incorrect tire pressure may adversely affect tire life and vehicle handling. The tire pressure should be checked when tires are COLD. Tires are considered COLD after the vehicle has been parked for 3 or more hours, or driven less than 1.6 km (1 mile). COLD tire pressures are shown on the tire placard. (See "Vehicle identification" (P.9-6) for the location of the tire placard.)

Insufficient pressure can lead to an overheating of the tire and subsequent internal damage. At high speeds, this could result in tread separation and even bursting of the tire.

### TYPES OF TIRES



#### CAUTION:

**When changing or replacing tires, be sure all four tires are of the same type (that is, summer, all season or snow) and construction. A NISSAN dealer may be able to help you with information about tire type, size, speed rating and availability.**

Replacement tires may have a lower speed rating than the factory equipped tires, and they may not match the potential maximum vehicle speed. Never exceed the maximum speed rating of the tire.

## All season tires

NISSAN specifies all season tires on some models to provide good performance all year, including snowy and icy road conditions. All season tires are identified by ALL SEASON and/or M&S on the tire sidewall. Snow tires have better snow traction than all season tires and may be more appropriate in some areas.

## Summer tires

NISSAN specifies summer tires on some models to provide superior performance on dry roads. Summer tire performance is substantially reduced in snow and ice. Summer tires do not have the tire traction rating M&S on the tire sidewall.

If you plan to operate your vehicle in snowy or icy conditions, NISSAN recommends the use of snow or all season tires on all four wheels.

## Snow tires

If snow tires are needed, it is necessary to select tires equivalent in size and load rating to the original equipment tires. If you do not, it can adversely affect the safety and handling of your vehicle.

Generally, snow tires have lower speed ratings than factory equipped tires and may not match the potential maximum vehicle speed. Never exceed the maximum speed rating of the tire. If you install snow tires, they must be the same size, brand, construction and tread pattern on all four wheels.

For additional traction on icy roads, studded tires may be used. However, some states and provinces prohibit their use. Check local, state and provincial laws before installing studded tires. Skid and traction capabilities of studded snow tires on wet or dry surfaces may be poorer than that of non-studded snow tires.

## 8-24 Maintenance and do-it-yourself

## TIRE CHAINS

Use of tire chains may be prohibited according to location. Check the local laws before installing tire chains. When installing tire chains, make sure that they are of proper size for the tires on your vehicle and are installed according to the chain manufacturer's instructions.

Use chain tensioners when recommended by the tire chain manufacturer to ensure a tight fit. Loose end links of the tire chains must be secured or removed to prevent the possibility of whipping action damage to the fenders or underbody. If possible, avoid fully loading your vehicle when using tire chains. In addition, drive at a reduced speed. Otherwise, your vehicle may be damaged and/or vehicle handling and performance may be adversely affected.

Tire chains must be installed only on the front wheels and not on the rear wheels. Never install tire chains on a temporary-use spare tire (TEMPORARY USE) (if equipped). Do not use the chains on dry roads.

## TIRE ROTATION

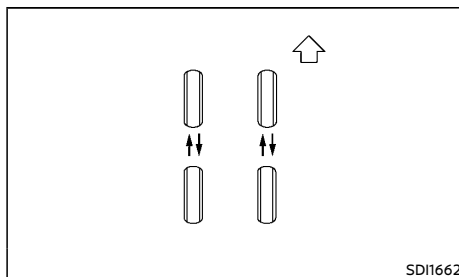

NISSAN recommends that tires be rotated every 10,000 km (6,000 miles). However, the timing for tire rotation may vary according to

your driving habits and the road surface conditions. (See "Flat tire" (P.6-2) for the tire replacement.)



### WARNING:

- **After rotating the tires, adjust the tire pressure.**
- **Retighten the wheel nuts when the vehicle has been driven for 1,000 km (600 miles) (also in cases of a flat tire, etc.).**
- **Do not include the temporary-use spare tire (if equipped) in tire rotation.**
- **Incorrect tire selection, fitting, care or maintenance can affect vehicle safety with risk of accident and injury. If in doubt, consult a NISSAN dealer or the tire manufacturer.**

## TIRE WEAR AND DAMAGE

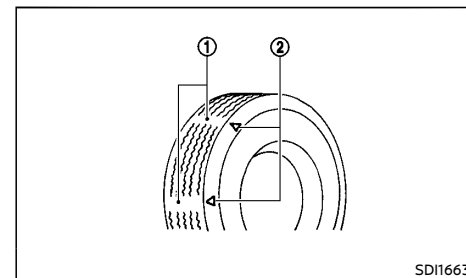

- ① Wear indicator
- ② Wear indicator location marks. The locations are shown by "Δ", "TWI", etc. depending on tire types.

Tires should be periodically inspected for wear, cracking, bulging or objects caught in the tread. If excessive wear, cracks, bulging or deep

cuts are found, the tire should be replaced immediately.

The original tires have a built-in tread wear indicator. When the wear indicator is visible, the tire should be replaced.

Improper service of a spare tire (if equipped) may result in serious personal injury. If it is necessary to repair the spare tire, contact a NISSAN dealer.

### TIRE AGE

Never use a tire over six years old, regardless of whether it has been used or not.

Tires degrade with age as well as with the vehicle usage. Have your tires checked and balanced often by a repair shop or, if you prefer, a NISSAN dealer.

### CHANGING TIRES AND WHEELS



#### WARNING:

**Do not install a deformed wheel or tire even if it has been repaired. Such wheels or tires could have structural damage and could fail without warning.**

When replacing a tire, use the same size, speed rating and load carrying capacity as originally equipped. (See "Tires and wheels" (P.9-5).) The use of tires other than those recommended or the mixed use of tires of different brands, construction (bias, bias-belted, or radial), or tread patterns can adversely affect the ride, braking, handling, ground clearance, body-to-tire clearance, snow chain clearance, speedometer calibration, headlight aim and bumper height. Some of these effects may lead to accidents and could result in serious personal injury.

If the wheels are changed for any reason,

always replace with wheels which have the same offset dimension. Wheels of a different offset could cause early tire wear, possibly degraded vehicle handling characteristics and/or interference with the brake discs/drums. Such interference can lead to decreased braking efficiency and/or early brake pad/shoe wear.

### WHEEL BALANCE

Unbalanced wheels may affect vehicle handling and tire life. Even with regular use, wheels can get out of balance. Therefore, they should be balanced as required.

### SPARE TIRE (if equipped)

Temporary-use (T-type) spare tire

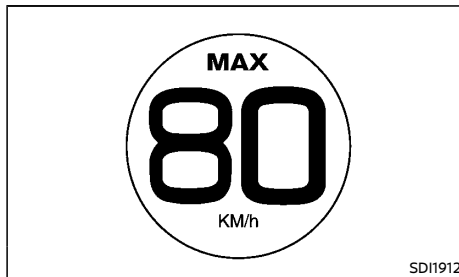

Spare tire label

Observe the following precautions if the T-type spare tire must be used, otherwise your vehicle could be damaged or involved in an accident.



#### CAUTION:

- **The T-type spare tire should be used only for emergency. It should be replaced by the standard tire at the first opportunity.**

- **Drive carefully while the T-type spare tire is installed.**
- **Avoid sharp turns and abrupt braking while driving.**
- **Periodically check the T-type spare tire inflation pressure, and always keep it at 420 kPa (4.2 bar, 60 psi).**
- **Do not drive your vehicle at speeds faster than 80 km/h (50 MPH).**
- **Do not use tire chains on a T-type spare tire. Tire chains will not fit properly on the T-type spare tire and may cause damage to the vehicle.**
- **When driving on roads covered with snow or ice, the T-type spare tire should be used on the rear wheel and the original tire used on the front wheels (drive wheels). Use tire chains only on the front two original tires.**
- **Tire tread of the T-type spare tire will wear at a faster rate than the original tire. Replace the T-type spare tire as soon as the tread wear indicators appear.**
- **Because the T-type spare tire is smaller than the original tire, ground clearance is reduced. To avoid damage to the vehicle do not drive over obstacles. Also do not drive the vehicle through an automatic car wash since it may get caught.**
- **Do not use the T-type spare tire on other vehicles.**
- **Do not use more than one T-type spare tire at the same time.**

## EMERGENCY TIRE PUNCTURE REPAIR KIT (if equipped)

The emergency tire puncture repair kit is supplied to the vehicle instead of a spare tire. The kit must be used for temporarily fixing a minor tire puncture. After using the repair kit, see a NISSAN dealer as soon as possible for tire inspection and repair/replacement.

See "Flat tire" (P.6-2) for more details.

# 9 Technical information

Recommended fluids/lubricants and capacities .....	9-2	Vehicle Identification Number (VIN) .....	9-6
Fuel information .....	9-3	Engine serial number .....	9-6
Recommended SAE viscosity number .....	9-3	Tire placard .....	9-6
Air conditioner system refrigerant and lubricant .....	9-3	Air conditioner specification label .....	9-7
Engine .....	9-4	Installation of an RF transmitter .....	9-7
Tires and wheels .....	9-5	Radio approval number and information .....	9-8
Dimensions .....	9-5	For Thailand .....	9-8
When travelling or registering in another country .....	9-6	For the Philippines .....	9-8
Vehicle identification .....	9-6	For Vietnam .....	9-8
Vehicle identification label .....	9-6		



## RECOMMENDED FLUIDS/ LUBRICANTS AND CAPACITIES

The following are approximate capacities. The actual refill quantities may be slightly different. When refilling, follow the procedures instructed in the "8. Maintenance and do-it-yourself" section to determine the proper refill capacity.

Fluid type		Capacity (approximate)			Recommended Fluids/Lubricants
		Metric Measure	US Measure	Imperial Measure	
Fuel		35 L	9-1/4 gal	7-3/4 gal	See "Fuel information" (P.9-3).
Engine oil  Drain and refill * For additional information, see "Changing engine oil and oil filter" (P.8-7).	with oil filter change	3.6 L	3-7/8 qt	3-1/8 qt	<ul style="list-style-type: none"> <li>· Genuine "NISSAN Motor Oil 0W-20 SN" is recommended.</li> <li>· If the above motor oil is not available, use "NISSAN Motor Oil" or equivalent that matches the following grade and viscosity.               <ul style="list-style-type: none"> <li>· Oil grade: API SN, ILSAC GF-5</li> <li>· SAE Viscosity: See "Recommended SAE viscosity number" (P.9-3).</li> </ul> </li> </ul>
	without oil filter change	3.2 L	3-3/8 qt	2-7/8 qt	
Engine coolant (with reservoir tank capacity 0.7 L)		6.14 L	6-1/2 qt	5-3/8 qt	<ul style="list-style-type: none"> <li>· Genuine NISSAN Engine Coolant (blue) or equivalent</li> <li>· Use Genuine NISSAN Engine Coolant or equivalent in its quality, in order to avoid possible aluminum corrosion within the engine cooling system caused by the use of non-genuine engine coolant.</li> <li>· Note that any repairs for the incidents within the engine cooling system while using non-genuine engine coolant may not be covered by the warranty even if such incidents occurred during the warranty period.</li> </ul>
Continuously Variable Transmission (CVT) fluid		—	—	—	<ul style="list-style-type: none"> <li>· Genuine NISSAN CVT Fluid NS-3</li> <li>· Use only Genuine NISSAN CVT Fluid NS-3. Using transmission fluid other than Genuine NISSAN CVT Fluid NS-3 will damage the CVT, which is not covered by the warranty.</li> </ul>
Manual Transmission (MT) gear oil		—	—	—	<ul style="list-style-type: none"> <li>· Genuine NISSAN Manual Transmission Fluid (MTF) HQ Multi 75W-85 or equivalent</li> <li>· If Genuine NISSAN Manual Transmission Fluid (MTF) HQ Multi is not available, API GL-4, Viscosity SAE 75W-85 may be used as a temporary replacement. However, use Genuine NISSAN Manual Transmission Fluid (MTF) HQ Multi as soon as it is available.</li> </ul>
Brake and clutch fluid		Refill to the proper fluid level according to the instructions in the "8. Maintenance and do-it-yourself" section.			<ul style="list-style-type: none"> <li>· Genuine NISSAN Brake Fluid or equivalent DOT 3</li> </ul>
Multi-purpose grease		—	—	—	<ul style="list-style-type: none"> <li>· NLGI No. 2 (Lithium soap base)</li> </ul>
Air conditioner system refrigerant		—	—	—	<ul style="list-style-type: none"> <li>· HFC-134a (R-134a)</li> </ul>
Air conditioner system lubricants		—	—	—	<ul style="list-style-type: none"> <li>· NISSAN A/C System Oil DH-PR (PAG) or equivalent</li> </ul>

## FUEL INFORMATION

Gasoline engine (model with three-way catalyst)



### CAUTION:

**Do not use leaded gasoline. Using leaded gasoline will damage the three-way catalyst.**

#### For Thailand:

Use UNLEADED PREMIUM gasoline or gasohol (up to E20\*) with an octane rating of at least 95 (RON).

If unleaded premium gasoline is not used, UNLEADED REGULAR gasoline with an octane rating of at least 91 (RON) may be used at slightly reduced performance. However, for maximum vehicle performance and the best driveability, the use of unleaded premium gasoline is recommended.

\*: Gasohol is alcohol blended gasoline. For example, "E20" is a mixture of approximately 20% fuel ethanol and 80% unleaded gasoline.

#### Except for Thailand:

Use UNLEADED PREMIUM gasoline with an octane rating of at least 95 (RON).

If unleaded premium gasoline is not used, UNLEADED REGULAR gasoline with an octane rating of at least 91 (RON) may be used at slightly reduced performance. However, for maximum vehicle performance and the best driveability, the use of unleaded premium gasoline is recommended.

## RECOMMENDED SAE VISCOSITY NUMBER

Gasoline engine oil

**0W-20 is preferable.**

**If 0W-20 is not available, select the viscosity, from the chart below, that is suitable for the outside temperature range.**

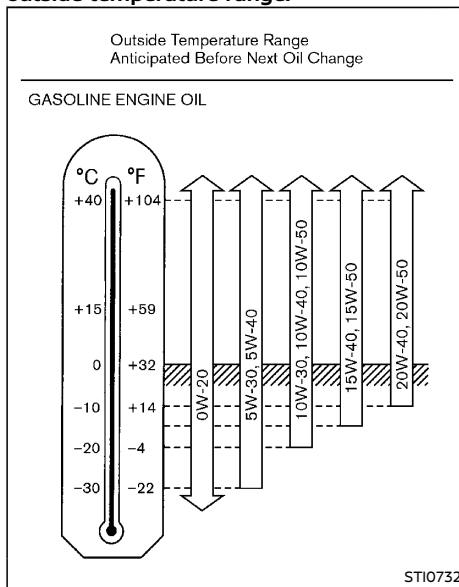

## AIR CONDITIONER SYSTEM REFRIGERANT AND LUBRICANT

The air conditioner system of your vehicle must be charged with the refrigerant HFC-134a (R134a) and the lubricant NISSAN A/C System Oil DH-PR (PAG) or equivalents. Use of any other refrigerants or lubricants will cause severe damage, and you may need to replace your vehicle's entire air conditioner system.

The release of refrigerants into the atmosphere is prohibited in many countries and regions. The refrigerant HFC-134a (R-134a) in your vehicle will not harm the Earth's ozone layer. However, it may contribute in a small part to the global warming effect. NISSAN recommends that the refrigerant be appropriately recovered and recycled. Contact a NISSAN dealer when servicing the air conditioner system.

## ENGINE

Engine Model		HRA0DET
Type		Gasoline, 4-cycle, DOHC
Cylinder arrangement		3-cylinder, in-line
Bore × Stroke	mm (in)	72.2 × 81.3 (2.843 × 3.201)
Displacement	cm <sup>3</sup> (cu in)	999 (60.96)
Idle speed at the "N" (Neutral) position	rpm	800
Ignition timing (B.T.D.C.)		CVT: 5° ±5 MT: 4° ±5
Spark plugs	Type	Standard
	Spark plug gap	mm (in)
		ILKAR7Q7 0.7 (0.028)
Camshaft operation		Timing chain



## TIRES AND WHEELS

	Standard	Spare*1
Tire size	195/65R15 91H 205/55R16 91V	T125/70 D15 95M*2
	Size	Offset mm (in)
Road wheel	Steel	15×5-1/2J 45 (1.77)
	Aluminum	15×5-1/2J 45 (1.77)
		16×6J 50 (1.97)
Spare	Steel	15×4T*2 30 (1.18)

\*1: For model without a spare tire, an emergency tire puncture repair kit is supplied.

\*2: Temporary use only

## DIMENSIONS

	Unit: mm (in)
Overall length	4,495 (177.0)*1
	4,530 (178.3)*2
Overall width	1,740 (68.5)
Overall height	1,455 (57.3)*3*4
	1,460 (57.5)*5
Front tread	1,525 (60.0)
Rear tread	1,535 (60.4)
Wheelbase	2,620 (103.1)

\*1: 195/65R15 91H tire equipped model

\*2: 205/55R16 91H tire equipped model and model with rear spoiler for Thailand

\*3: Continuously Variable Transmission (CVT) model for the Philippines

\*4: 205/55R16 91H tire equipped model for Vietnam

\*5: Except for CVT model for the Philippines and 205/55R16 91H tire equipped model for Vietnam

## WHEN TRAVELLING OR REGISTERING IN ANOTHER COUNTRY

When planning to travel in another country or region, find out whether the fuel required for your vehicle is available in that country or region. Using a low octane rated fuel may cause engine damage. Therefore, be sure that the required fuel is available wherever you go. For additional information regarding recommended fuel, see "Fuel information" (P.9-3).

When transferring the registration of your vehicle to another country, state, province or district, contact the appropriate authorities to find out that the vehicle complies with the local legal requirements. In some cases, a vehicle cannot meet the legal requirements, and it may be necessary to modify the vehicle to meet local laws and regulations. In addition, there may be possibilities that a vehicle cannot be adapted in certain areas.

The laws and regulations for motor vehicle emission control and safety standards vary according to the country, state, province or district; therefore, the vehicle specification may differ.

When any vehicles are to be taken into another country, state, province or district, its modification, transportation, registration, and any other expenses which may result, are the responsibility of the user. NISSAN is not responsible for any inconveniences that may result.

## VEHICLE IDENTIFICATION

It is prohibited to cover, paint, weld, cut, drill, alter or remove Vehicle Identification Number (VIN).

### VEHICLE IDENTIFICATION LABEL

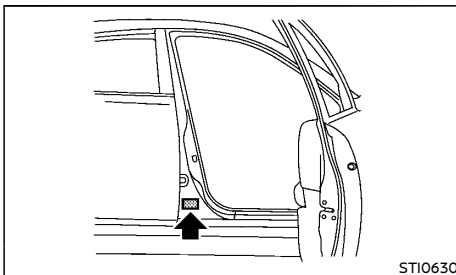

The vehicle identification label is affixed to the right side center pillar.

### VEHICLE IDENTIFICATION NUMBER (VIN)

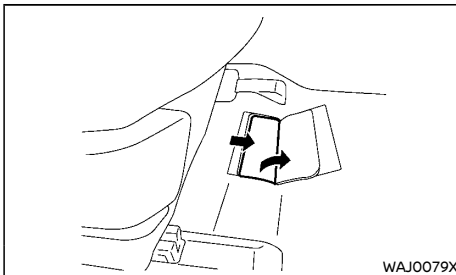

The vehicle identification number is stamped under the front right-side seat as shown.

### ENGINE SERIAL NUMBER

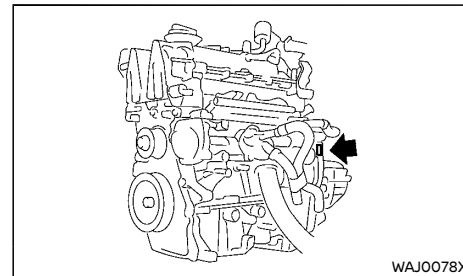

The engine serial number is stamped on the engine as shown.

### TIRE PLACARD

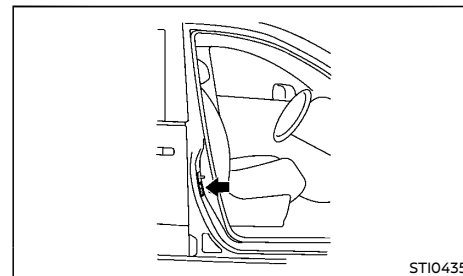

#### Right-Hand Drive (RHD) model

The cold tire pressures are shown on the tire placard affixed to the driver's side center pillar.

## INSTALLATION OF AN RF TRANSMITTER

### AIR CONDITIONER SPECIFICATION LABEL

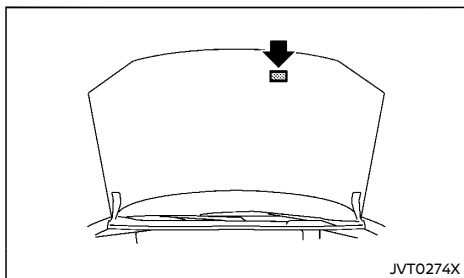

The air conditioner specification label is affixed to the underside of the hood as shown.

### For countries conforming to UN regulation No.10 or equivalent:

The installation of an RF transmitter in your vehicle could affect electric equipment systems. Be sure to check with your NISSAN dealer for precautionary measures or special instructions regarding installation. Upon request, your NISSAN dealer will provide the detailed information (frequency band, power, antenna position, installation guide, etc.) regarding installation.

## RADIO APPROVAL NUMBER AND INFORMATION

### FOR THAILAND

This telecommunication equipment is in compliance with NBTC requirements.

- BCM (Body Control Module)

### Front radar sensor (if equipped)

- 1) เครื่องโทรคมนาคมและอุปกรณ์นี้มีความสอดคล้องตามมาตรฐานหรือข้อกำหนดของ กสทช.
- 2) เครื่องวิทยุคมนาคมมีระบบการแผ่คลื่นแม่เหล็กไฟฟ้าสอดคล้องตามมาตรฐานความสอดคล้องต่อสัญญาของมนุษย์จากการใช้เครื่องวิทยุคมนาคมที่คณะกรรมการกิจการโทรคมนาคมแห่งชาติได้ประกาศกำหนด

WAJ0082X

### FOR THE PHILIPPINES

### Side radar sensor (if equipped)



JVT0508X

### FOR VIETNAM

### Intelligent Key system (if equipped)



WAJ0243X

Remote keyless entry system (if equipped)

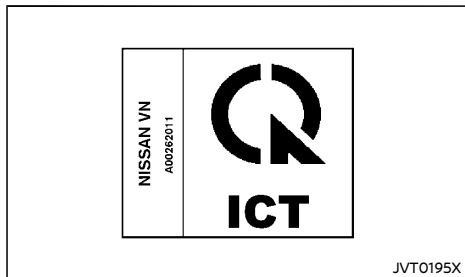

Side radar sensor (if equipped)

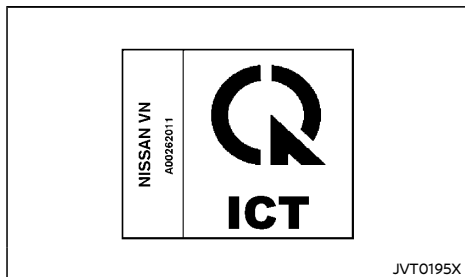

**MEMO**

**MEMO**

**MEMO**



# 10 Index

## A

Air bag system.....	1-23
Air bag warning labels.....	1-22
Air bag warning light.....	1-23
Supplemental curtain side-impact air bag system.....	1-19, 1-24
Supplemental front-impact air bag system.....	1-19, 1-24
Supplemental side-impact air bag system.....	1-19, 1-24
Air cleaner filter.....	8-12
Air conditioner	
Air conditioner operation.....	4-14
Air conditioner service.....	4-20
Air conditioner specification label.....	9-7
Air conditioner system refrigerant and lubricant.....	9-3
Aluminum alloy wheels.....	7-3
AM-FM Radio with USB (Universal Serial Bus) connection port.....	4-26
Antenna.....	4-32
Anti-lock Braking System (ABS).....	5-41
Anti-lock braking system (ABS) warning light.....	2-13
Appearance care	
Exterior appearance care.....	7-2
Interior appearance care.....	7-3
Armrest.....	1-4
Audible reminders.....	2-17
Audio operation precautions.....	4-20
Audio system.....	4-20
Automatic air conditioner.....	4-18
Auxiliary input jack.....	4-31

## B

Battery.....	8-4, 8-14
Battery replacement, Intelligent Key.....	8-16

Battery replacement,	
Remote controller.....	8-15
Intelligent Key.....	8-16
Intelligent Key battery discharge.....	5-9
Vehicle battery.....	8-14
Battery saver system.....	2-32
Before starting engine.....	5-3
Before using emergency tire puncture repair kit.....	6-6
Belts (See drive belts).....	8-9
Blind Spot Warning (BSW).....	5-20
Blocking wheels.....	6-3
Bluetooth® audio.....	4-30
Bluetooth® Hands-Free Phone System.....	4-33
Bluetooth® settings.....	4-35
Brake	
Brake booster.....	8-10
Brake fluid.....	8-10
Brake precautions.....	5-40
Brake system.....	5-40
Brakes.....	8-9
Checking foot brake pedal.....	8-9
Checking parking brake.....	8-9
Parking brake.....	3-21, 5-43
Warning light.....	2-13
Brake assist.....	5-40
Brake precautions.....	5-40
Brakes.....	8-9
Break-in schedule.....	5-3
Brightness control, Instrument panel.....	2-10
Bulb replacement.....	8-2, 8-19

## C

Card holder.....	2-39
Care when driving.....	5-5
Catalytic converter, Three way catalyst.....	5-4
Changing	
Changing engine coolant.....	8-6

Changing engine oil and oil filter.....	8-7
Changing flat tire.....	6-3
Changing tires and wheels.....	8-25
Checking	
Checking engine coolant level.....	8-6
Checking engine oil level.....	8-7
Checking foot brake pedal.....	8-9
Checking lights.....	2-13
Checking parking brake.....	8-9
Child restraint anchorage.....	1-14
Child restraint installation using ISOFIX.....	1-14
Child restraint installation using three-point type seat belt.....	1-16
Child restraints.....	1-10
Child safety.....	1-8
Child safety rear door lock.....	3-4
Chimes, Audible reminders.....	2-17
Chrome parts.....	7-3
Circuit breaker, Fusible link.....	8-17
Cleaning exterior and interior.....	7-2, 7-3
Clock.....	2-30
Closing hood.....	3-17
Clutch fluid.....	8-11
Cockpit.....	2-2
Cold weather driving.....	5-42
Console box.....	2-38
Continuously Variable Transmission (CVT).....	5-6, 5-8
Continuously Variable Transmission (CVT) fluid.....	8-11
Continuously Variable Transmission position indicator.....	2-11
Coolant	
Changing engine coolant.....	8-6
Checking engine coolant level.....	8-6
Coolant Temp. (trip computer).....	2-30
High Coolant Temp warning.....	2-26
High temperature warning light.....	2-14
Corrosion protection.....	7-5
Cup holders.....	2-39

CVT Error warning..... 2-27

## D

Defogger switch..... 2-34  
Dimensions..... 9-5  
Display  
    Vehicle information display..... 2-18, 2-19  
Distance to empty..... 2-9  
Doors..... 3-3  
Drive belts..... 8-9  
Driving  
    Care when driving..... 5-5  
    Cold weather driving..... 5-42  
    Driving in wet conditions..... 5-5  
    Driving in winter conditions..... 5-5  
    Driving with Continuously Variable  
    Transmission (CVT)..... 5-11  
    Driving with Manual  
    Transmission (MT)..... 5-14  
    Precautions when starting  
    and driving..... 5-3  
Driving vehicle..... 5-11

## E

ECO Drive Report..... 2-10  
Economy, Fuel..... 5-36  
Electric power steering..... 5-39  
Electric power steering warning light..... 2-14  
Emergency Brake  
    Intelligent Emergency  
    Braking system..... 5-30  
Emergency tire puncture repair kit..... 6-5, 8-26  
Engine  
    Before starting engine..... 5-3  
    Break-in schedule..... 5-3  
    Changing engine coolant..... 8-6  
    Changing engine oil and oil filter..... 8-7  
    Checking engine coolant level..... 8-6  
    Checking engine oil level..... 8-7

Engine compartment  
    check locations..... 8-5  
Engine cooling system..... 8-6  
Engine oil..... 8-7  
Engine serial number..... 9-6  
Engine specifications..... 9-4  
Engine start operation indicator  
    (for Continuously Variable  
    Transmission model)..... 2-25  
Engine start operation indicator  
    (for Manual Transmission  
    (MT) model)..... 2-27  
    If your vehicle overheats..... 6-12  
    Spark plugs..... 8-9  
Engine cold start period..... 5-5  
Engine start operation indicator..... 2-25  
Engine start operation indicator light..... 2-16  
Exhaust gas (carbon monoxide)..... 5-4  
Explanation of general  
    maintenance items..... 8-2  
Extended storage fuse switch..... 8-18  
Exterior lights..... 8-19

## F

Flat tire..... 6-2  
Floor mats..... 7-4  
Fluid  
    Brake fluid..... 8-10  
    Clutch fluid..... 8-11  
    Continuously Variable Transmission  
    (CVT) fluid..... 8-11  
    Engine coolant..... 8-6  
    Engine oil..... 8-7  
    Recommended fluids/lubricants  
    and capacities..... 9-2  
    Window washer fluid..... 8-4, 8-13  
Fog light switch..... 2-33  
Freeing trapped vehicle..... 6-14  
Front seats..... 1-2  
Front-impact air bag system..... 1-24

Fuel  
    Fuel economy..... 5-36  
    Fuel gauge..... 2-9  
    Fuel information..... 9-3  
    Fuel octane rating..... 9-3  
    Fuel-filler cap..... 3-19  
    Fuel-filler lid..... 3-18  
    Opening fuel-filler lid..... 3-18  
    Recommended fluids/lubricants  
    and capacities..... 9-2  
Fuel Efficiency and Carbon Dioxide  
    Reduction driving tips..... 5-36  
Fuel-filler cap..... 3-19  
Fuel-filler lid..... 3-18  
Fuses..... 8-17  
Fusible links..... 8-17

## G

Gauge  
    Fuel gauge..... 2-9  
    Speedometer..... 2-8  
    Tachometer..... 2-8  
    Trip computer..... 2-18, 2-28  
General maintenance..... 8-2  
Glove box..... 2-38

## H

Hazard indicator and outside chime..... 3-13  
Hazard indicator flasher switch..... 6-2  
Head restraints..... 1-4  
Headlight  
    Headlight and turn signal switch..... 2-30  
Headlights  
    Bulb replacement..... 8-19  
    Headlight switch..... 2-30  
Heater  
    Heater and air  
    conditioner operation..... 4-14  
High Coolant Temp warning..... 2-26

High temperature warning light.....	2-14
Hill start assist system.....	5-20
Hood release.....	3-16
Horn.....	2-35

## I

Idling Stop OFF switch.....	5-17
Idling Stop System.....	5-15
Ignition switch	
Ignition switch positions.....	5-8
Key positions.....	5-6
Model without Intelligent Key system....	5-6
Push-button ignition switch (model with Intelligent Key system).....	5-7
Ignition switch positions.....	5-8
Indicator	
Vehicle information display.....	2-19
Indicator lights.....	2-16
Injured persons.....	1-9
Inside rearview mirror.....	3-19
Installing spare tire.....	6-4
Instrument brightness control.....	2-10
Instrument panel.....	2-4
Intelligent Around View Monitor.....	4-3
Intelligent Emergency Braking system.....	5-30
Intelligent Emergency Braking system warning light.....	2-14
Intelligent Key.....	3-2
Intelligent Key battery.....	8-16
Intelligent Key battery discharge.....	5-9
Intelligent Key system.....	3-6, 5-7
Intelligent Key system warning light....	2-14
Key System Error warning.....	2-25
Interior lights.....	2-40, 8-20
ISOFIX child restraint system.....	1-13

## J

Jump starting.....	6-10
--------------------	------

## K

### Key

Ignition switch (model without Intelligent Key system).....	5-6
Intelligent Key battery.....	8-16
Intelligent Key battery discharge.....	5-9
Intelligent Key system.....	3-6, 5-7
Key positions.....	5-6
Keys.....	3-2
Locking with key.....	3-3
Mechanical key.....	3-2, 3-3
NISSAN Anti-Theft System (NATS) key....	3-2
Using Intelligent Key system.....	3-8
Using remote keyless entry system.....	3-5
Using remote keyless entry system (Intelligent Key).....	3-13
Key Battery Low warning.....	2-25
Key ID Incorrect warning.....	2-25
Key System Error warning.....	2-25
Keyless entry (See remote keyless entry system).....	3-5, 3-13

## L

### Labels

Air conditioner specification label.....	9-7
Engine serial number.....	9-6
Vehicle identification number.....	9-6

### Light

Bulb replacement.....	8-2, 8-19
Exterior lights.....	8-19
Fog light switch.....	2-33
Headlight and turn signal switch.....	2-30
Headlight switch.....	2-30
Headlights.....	8-19
Indicator lights.....	2-16
Interior lights.....	2-40, 8-20
Light locations.....	8-21
Map lights.....	2-40
Replacement.....	8-2, 8-19

Room light.....	2-41
Trunk light.....	2-41
Warning lights.....	2-13
Lock	
Anti-lock Braking System (ABS).....	5-41
Child safety rear door lock.....	3-4
Doors.....	3-3
Locking with inside lock knob.....	3-4
Locking with key.....	3-3
Locking with power door lock switch....	3-4
Steering lock.....	5-8
Low Fuel warning.....	2-25
Low fuel warning light.....	2-15
Low outside temperature warning.....	2-30

## M

### Maintenance

Battery.....	8-4, 8-14
Explanation of general maintenance items.....	8-2
General maintenance.....	8-2
Maintenance precautions.....	8-4
Maintenance requirements.....	8-2
Scheduled maintenance.....	8-2
Seat belt maintenance.....	1-9
Making a call.....	4-34
Malfunction indicator light (MIL).....	2-16
Manual air conditioner.....	4-15
Manual Transmission (MT).....	5-6
Map lights.....	2-40
Master warning light.....	2-15
Mechanical key.....	3-2, 3-3
Meter	
Trip computer.....	2-18, 2-28
Meters and gauges.....	2-6
Instrument brightness control.....	2-10
Mirror	
Inside rearview mirror.....	3-19
Mirrors.....	3-19
Outside rearview mirrors.....	3-20

Moving Object Detection (MOD) function.....	4-11
---	------

## N

New vehicle break-in.....	5-3
NISSAN Anti-Theft System (NATS).....	3-15
NISSAN Anti-Theft System (NATS) key.....	3-2
NissanConnect Owner's Manual.....	4-2
No Key Detected warning.....	2-25

## O

Odometer/Twin trip odometer.....	2-8
Oil	
Changing engine oil and oil filter.....	8-7
Checking engine oil level.....	8-7
Engine oil.....	8-7
Opening fuel-filler lid.....	3-18
Opening hood.....	3-17
Outside air temperature.....	2-30
Outside rearview mirrors.....	3-20
Overheat, if your vehicle overheats.....	6-12

## P

Parking	
Parking brake.....	3-21
Parking, Parking brake.....	5-43
Passenger compartment.....	8-18
Phone	
Bluetooth® Hands-Free Phone System.....	4-33
Power	
Electric power steering.....	5-39
Locking with power door lock switch.....	3-4
Power outlet.....	2-37
Power windows.....	2-35
Pre-tensioner seat belt system.....	1-22, 1-27
Precautions	
Audio operation.....	4-20

Brake precautions.....	5-40
Maintenance.....	8-4
Precautions on child restraint usage.....	1-10
Precautions on push-button ignition switch operation.....	5-7
Precautions on Supplemental Restraint System.....	1-19
Precautions when starting and driving.....	5-3
Seat belt usage.....	1-6
Towing precautions.....	6-13
Pregnant women.....	1-8
Preparing tools.....	6-2
Push starting.....	6-12
Push-button ignition switch.....	5-7

## R

Radio.....	4-20
AM-FM Radio with USB connection port.....	4-26
Rear Cross Traffic Alert (RCTA).....	5-26
Rear seats.....	1-3
Recommended fluids/lubricants and capacities.....	9-2
Recommended SAE viscosity number.....	9-3
Remote keyless entry system	
Remote keyless entry system (Intelligent Key).....	3-13
Removing spots.....	7-2
Removing tire.....	6-3
Repairing flat tire.....	6-5
Rod antenna.....	4-32
Room light.....	2-41

## S

Safety	
Child safety.....	1-8
Child safety rear door lock.....	3-4

Scheduled maintenance.....	8-2
Seat	
Front seats.....	1-2
Precautions on seat belt usage.....	1-6
Seat belts.....	1-6, 7-4
Seats.....	1-2
Three-point type seat belts.....	1-9
Seat belt warning light.....	2-15
Seat belt(s)	
Child safety.....	1-8
Cleaning.....	7-4
Injured persons.....	1-9
Pre-tensioner seat belt system.....	1-22, 1-27
Precautions on seat belt usage.....	1-6
Pregnant women.....	1-8
Seat belt maintenance.....	1-9
Security system.....	3-15
Shift lever	
Shift lock release.....	5-13
Shift lock release	
Transmission.....	5-13
Soft bottle holder.....	2-39
Spare tire.....	8-25
Spark plugs.....	8-9
Speedometer.....	2-8
SPORT mode switch.....	5-13
SRS air bag deployment conditions.....	1-25
Starting	
Before starting engine.....	5-3
Jump starting.....	6-10
Precautions when starting and driving.....	5-3
Push starting.....	6-12
Starting engine (model with Intelligent Key system).....	5-10
Starting engine (model without Intelligent Key system).....	5-10
Steering	
Electric power steering.....	5-39
Steering lock.....	5-6, 5-8

Steering lock release malfunction indicator.....	2-25
Steering wheel.....	3-19
Steering wheel mounted switch.....	4-33
Stopping vehicle.....	6-2
Storage.....	2-38
Stowing damaged tire and tools.....	6-5
Sun visors.....	2-40
Supplemental air bag system	
Supplemental curtain side-impact air bag system.....	1-24
Supplemental front-impact air bag system.....	1-24
Supplemental side-impact air bag system.....	1-24
Supplemental air bag systems.....	1-23
Supplemental curtain side-impact air bag system.....	1-19, 1-24
Supplemental front-impact air bag system.....	1-19, 1-24
Supplemental Restraint System (SRS).....	1-19
Supplemental side-impact air bag system.....	1-19, 1-24
Switch	
Defogger switch.....	2-34
Fog light switch.....	2-33
Hazard indicator flasher switch.....	6-2
Headlight and turn signal switch.....	2-30
Headlight switch.....	2-30
Idling Stop OFF switch.....	5-17
Intelligent Emergency Braking system OFF switch.....	5-30
Power door lock switch.....	3-4
SPORT mode switch.....	5-13
Steering wheel mounted switch.....	4-30
Trip computer mode switch.....	2-18
Turn signal switch.....	2-32
Vehicle Dynamic Control (VDC) OFF switch.....	5-19
Wiper and washer switch.....	2-33

## T

Tachometer.....	2-8
Theft warning system.....	3-15
Three-point type seat belts.....	1-9
Three-way catalyst.....	5-4
Tire	
Changing tires and wheels.....	8-25
Installing tire.....	6-4
Preparing tools.....	6-2
Removing tire.....	6-3
Spare tire.....	8-25
Stowing damaged tire and tools.....	6-5
Tire age.....	8-25
Tire equipment.....	5-42
Tire inflation pressure.....	8-23
Tire placard.....	9-6
Tire wear and damage.....	8-24
Tires and wheels.....	8-23, 9-5
Tires	
Flat tire.....	6-2
Tire chains.....	8-24
Tire rotation.....	8-3, 8-24
Types of tires.....	8-23
Towing	
Towing precautions.....	6-13
Towing recommended by NISSAN.....	6-14
Towing your vehicle.....	6-13
Trailer towing.....	5-39
Transmission	
Continuously Variable Transmission (CVT) fluid.....	8-11
Driving with Continuously Variable Transmission (CVT).....	5-11
Driving with Manual Transmission (MT).....	5-14
Transmission shift lever lock release.....	5-13
Transmitter (See remote keyless entry system).....	3-5, 3-13
Trip computer.....	2-18, 2-28
Troubleshooting guide.....	3-11

Trunk lid.....	3-17
Trunk light.....	2-41
Turn signal switch.....	2-32
Types of tires.....	8-23

## U

Underbody cleaning.....	7-3
USB (Universal Serial Bus) charging connector.....	2-37
USB connection port.....	4-31
Using Intelligent Key system.....	3-8
Using remote keyless entry system.....	3-5
Using remote keyless entry system (Intelligent Key).....	3-13

## V

Vehicle	
Dimensions.....	9-5
Identification number.....	9-6
Vehicle battery.....	8-14
Vehicle Dynamic Control (VDC) system.....	5-18
Vehicle dynamic control (VDC) warning light.....	2-15
Vehicle information display.....	2-18, 2-19
How to use the vehicle information display.....	2-20
Settings.....	2-20
Startup display.....	2-20
Vehicle information display warnings and indicators.....	2-24
Vehicle security.....	5-42
Ventilators.....	4-13

## W

Warning	
Intelligent Key system warning light.....	2-14
Key Battery Low warning.....	2-25
Key System Error warning.....	2-25

Lights.....	2-13
Vehicle information display.....	2-19
Warning lights.....	2-13
Warning lights, indicator lights and audible reminders.....	2-12
Washer switch	
Windshield wiper and washer switch.....	2-33
Washing.....	7-2
Waxing.....	7-2
Wheels and tires, Care of wheels.....	7-3
When travelling or registering in another country.....	9-6
Where to go for service.....	8-2
Window washer fluid.....	8-4, 8-13
Window(s)	
Cleaning.....	7-3, 7-4
Power windows.....	2-35
Windows.....	2-35
Windshield wiper and washer switch.....	2-33
Wiper	
Windshield wiper and washer switch.....	2-33
Wiper and washer switch.....	2-33
Wiper blades.....	8-12

**MEMO**

## GAS STATION INFORMATION

### FUEL INFORMATION

Gasoline engine (Model with three-way catalyst)



#### **CAUTION:**

**Do not use leaded gasoline. Using leaded gasoline will damage the three-way catalyst.**

#### **For Thailand:**

Use UNLEADED PREMIUM gasoline or gasohol (up to E20\*) with an octane rating of at least 95 (RON).

If unleaded premium gasoline is not used, UNLEADED REGULAR gasoline with an octane rating of at least 91 (RON) may be used at slightly reduced performance. However, for maximum vehicle performance and the best driveability, the use of unleaded premium gasoline is recommended.

\*: Gasohol is alcohol blended gasoline. For example, "E20" is a mixture of approximately 20% fuel ethanol and 80% unleaded gasoline.

#### **Except for Thailand:**

Use UNLEADED PREMIUM gasoline with an octane rating of at least 95 (RON).

If unleaded premium gasoline is not used, UNLEADED REGULAR gasoline with an octane rating of at least 91 (RON) may be used at slightly reduced performance. However, for maximum vehicle performance and the best driveability, the use of unleaded premium gasoline is recommended.

### RECOMMENDED ENGINE OIL

See "Recommended fluids/lubricants and capacities" (P.9-2).

### TIRE COLD PRESSURE

See the tire placard affixed to the driver's side center pillar.

## QUICK REFERENCE

- In case of emergency ... (P.6-1)  
(Flat tire, engine will not start, overheating, towing)
- How to start the engine ... (P.5-1)
- How to read the meters and gauges ... (P.2-1)
- Maintenance and do-it-yourself ... (P.8-1)
- Technical information ... (P.9-1)